

T R U S T T O M O T I O N

since
**19
76**

UYGAR[®]

ELEVATOR & ESCALATOR

S50
MODEL

KAPI YEDEK PARÇA LİSTESİ
SPARE PART LIST



FL201801DRSPRS50

Sertifikalarımız

Certificates

UYGAR[®]

Marka Tescil Belgesi
Trademark Registration Certificate

Ürün Uygunluk Belgeleri

Product Conformity Certificates

S50 Model

Kat Kapı Kilit / Landing Door Locking Device

eu-type examination certificate
by Liftinstituut

S50 Model

Kat Kapı Kilit / Landing Door Locking Device

certificate of conformity to type
by Liftinstituut

S50 Model

Kabin Kapı Kilit / Car Door Locking Device

type examination certificate
by Liftinstituut

S50 Model Kat Kapı ve

Kabin Kapı Sarkaç Test

Sertifikası / Landing Door and Car Door
Pendulum Test Certificate

type examination certificate
by Liftinstituut

Yangın Dayanıklılık Belgeleri

Fire Resistance Certificates

Asansör Kat Kapısı

Uygar 2P Merkez

EN81-58, E45, TSE

Elevator Landing Door
Uygar 2P Centre

Asansör Kat Kapısı

Uygar 2P Teleskopik

EN81-58, E120, TSE

Elevator Landing Door
Uygar 2P Telescopic

Yönetim Sistem Belgeleri

Management System Certificates

Kalite Yönetim Sistem Belgesi

ISO 9001: 2015

Certificate of quality
management system

Çevre Yönetim Sistem Belgesi

ISO 14001: 2015

Certificate of environmental
management system

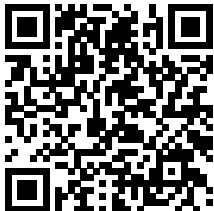

<http://www.uygar.com.tr/kalite-belgeleri,2,17049#.WxJoBFOFNUM>

Sertifikalarımızı belge formatında görmek isterseniz aşağıdaki linki girebilir yada yandaki QR kodu akıllı telefonunuzdan okutarak inceleyebilirsiniz.

If you want to see our certificates in document format, you can enter the following link or you can read the QR code on your smart phone by reading it.

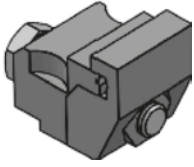
**DRS50ASM006**

Kapı Halat Alüminyum Tutturma Kiti
Door Rope Holder Kit

**DRS50ASM010**

Kapı Üst Makara 40/48 Kit
Door Roller 40/48 Kit

**DRS50ASM034**

Kapı Üst Makara 40/48
Door Top Rolller

**DRS50ASM009**

Kapı Alt Makara 24/30 Kiti
Door Bottom Roller 24/30 Kit

**DRS50ASM035**

Kapı Alt Makara 24/30
Door Bottom Roller 24/30

**DRS50ASM018**

Kapı Halat Tekerleği (Ø43,5mm)
Wheel of Door Rope (Ø47mm)

**DRS50ASM008**

Kapı Switch Kiti
Door Switch Kit

**DRS50PRT013**

Kapı Mekanizma Halat Yayı
Door Mechanism Rope Spring

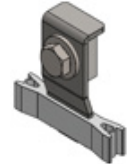
**DRS50ASM015**

Kapı Kızak Alt Kılavuz Kit
Door Side Guide Kit

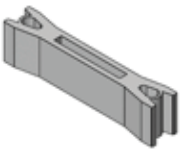
**DRS50PRT082**

Kapı Alt Kılavuz Pabucu
Door Bottom Guide Shoe

**DRS50PRT081**

Kapı Panel Plastik Kızak Sacı
Door Panel Sheet Of Plastic Sill

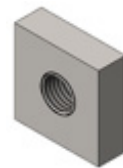
**DRS50PRT064**

Kapı Kare Somun M10
Landing Door Sqare Nut M10

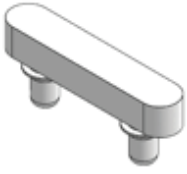
**DRS50PRT008**

Kapı Mekanizma Tamponu
Door Mechanism Buffer

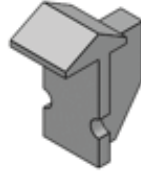
**LDRS50PRT080**

Kapı Yay Yanařma Sabitlemesi
Door Closing Spring Fixing

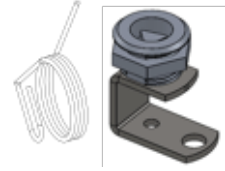
**LDRS50LCKASM006L**

Kat Kapı Mekanizma Dıřtan Acil Ama Sistemi S
Complete Door Release System Left
(indicate sense of opening)

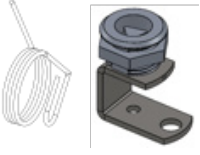
**LDRS50LCKASM006R**

Kat Kapı Mekanizma Dıřtan Acil Ama Sistemi Saę
Complete Door Release System
(indicate sense of opening) Right

**LDRS50LCKPRT003**

Kat Kapı Mekanizma Kilit Kaldırma
Makarası (Ø33 mm.
Lock Pick Up Roller (Ø33 mm.)

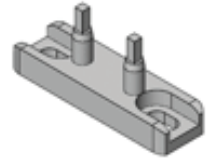
**DSKA1A**

PIZZATO Dikey Fiř
Contact Support

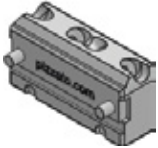
**DSAA1VA**

PIZZATO Kapı Kilit Kontak
Door Lock Contact

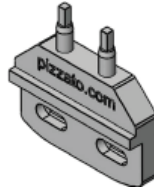
**DSKB1A**

PIZZATO Yatay Fiř
Contact Support

**LDRS50LCKASM003L**

Kat Kapı Mekanizma Komple
Kilit Anahtarı Ama Desteęi (sol)
Complete Lock Switch Support (left)

**LDRS50LCKASM003R**

Kat Kapı Mekanizma Komple
Kilit Anahtarı Ama Desteęi (saę)
Complete Lock Switch Support (right)

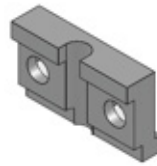
**LDRS50LCKPRT008**

Kat Kapı Mekanizma Kilit Ama ubuk Yataęı
Landing Door Release Rod Shaft

**LDRS50LCKPRT009R**

Kat Kapı Mekanizma
Kilit Ama ubuęu (saę)
Door Release Rod (right)

**LDRS50LCKPRT009L**

Kat Kapı Mekanizma
Kilit Açma Çubuğu (sol)
Landing Door Release Rod (left)

**CDRS50SKTPRT016**

Skate Mandalı (sabit)
Skate Trigger (fixed)

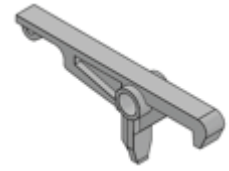
**CDRS50SKTPRT034**

Skate Mandalı (hareketli)
Skate Trigger (moving)

**CDRS50ASM005R**

Kabin Kapı Operatör VWF Motoru Sağ
VWF Motor Right

**CDRS50ASM005L**

Kabin Kapı Operatör VWF Motoru Sol
VWF Motor Left

**CDRS50PRT043**

Kabin Kapı Operatör Motor Kasnağı
Motor Operator Pulley

**CDRS50PRT028**

Kabin Kapı Operatör Karşı Dönüş Kasnağı
Return Pulley

**LDRS50PRT081160**

Mekanizma Kapama Yayı 160 cm
Mechanism Closing Spring 160 cm

**LDRS50PRT081200**

Mekanizma Kapama Yayı 200cm
Mechanism Closing Spring 200 cm

**LDRS50PRT081240**

Mekanizma Kapama Yayı 240 cm
Mechanism Closing Spring 240 cm

**LDRS50PRT081280**

Mekanizma Kapama Yayı 280 cm
Mechanism Closing Spring 280 cm

**CDRS50ASM111**

Kabin Kapı Operatör Montaj Konsolu
Operator Support

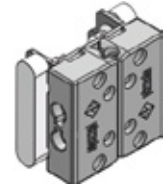
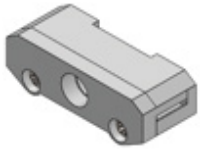
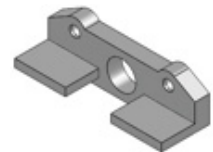
**LDRS50ASM003L**Kat Kapı Montaj Konsolu Sol
Mounting Bracket for Landing Doors Left**LDRS50ASM003R**Kat Kapı Montaj Konsolu Sağ
Mounting Bracket for Landing Doors Right**CDRS50ASM004**Skate Mandal Seti
Skate Trigger Bracket & Spring**CDRS50SKTASM004**Skate Motor Kayış Bağlama Kiti
Skate Motor Belt Holder Kit**CDRS50SKTPRT019**Skate Motor Kayış Sabitleme Plastiđi
Skate Motor Belt Fixing Plastic**CDRS50SKTPRT018**Skate Motor Kayış Sıkıřtırma Plastiđi
Skate Motor Belt Compress Plastic**CDRS50SKTPRT023**Skate Kilit Kolu Yayısı
Skate Lock Arm Spring**CDRS50SKTPRT031R**Skate Ana Cövde Yayısı Sağ
Skate Main Body Spring Right**CDRS50SKTPRT031L**Skate Ana Cövde Yayısı Sol
Skate Main Body Spring Left**CDRS50SKTPRT022**Skate Tetikleme Yayısı
Skate Trigger Spring**CDRS50PRT025**Kabin Kapı Operatör Trafo ve Kartı (ANKA)
Operator Electronic Card

**CDRS50SKTASM003L**

Skate Kilit Kiti Sol
Skate Lock Kit Left

**CDRS50SKTASM003R**

Skate Kilit Kiti Sağ
Skate Lock Kit Right

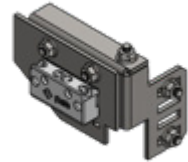
**CDRS50SKTLCKL**

Skate S50 Kilit Sol
Skate S50 Lock Left

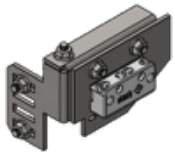
**CDRS50SKTLCKR**

Skate S50 Kilit Sağ
Skate S50 Lock Right

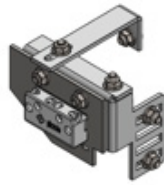
**CDRS50SKTLCKC**

Skate S50 Kilit Merkez
Skate S50 Lock Centre

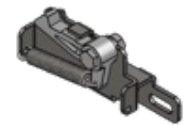
**CDRS50SKTTRGLT**

Kabin Kapı Skate Kilit Kiti Sol Teleskop
Car Door Skate Lock Kit Left Telescopic

**CDRS50SKTASM007**

Kapı Kilit Açma Halat Seti EN 81-20/50
Door Unlocking Rope Set EN 81-20/50

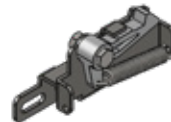
**CDRS50SKTTRGRT**

Kabin Kapı Skate Kilit Kiti Sağ Teleskop
Car Door Skate Lock Kit Right Telescopic

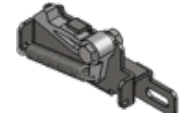
**CDRS50SKTTRGC**

Kabin Kapı Skate Kilit Kiti Merkez
Car Door Skate Lock Kit Centre

Fiyat/Price

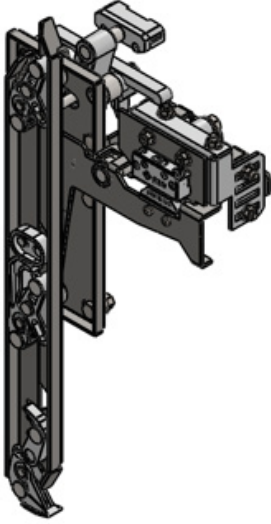

Skate EN 81-20/50 Kilit Kit Sol
CDRS50LCK02L

Kabin Kapı S50 Skate EN 81-20/50 Kilit Kit Sol
Car Door S50 Skate EN 81-20/50 Lock Kit Left

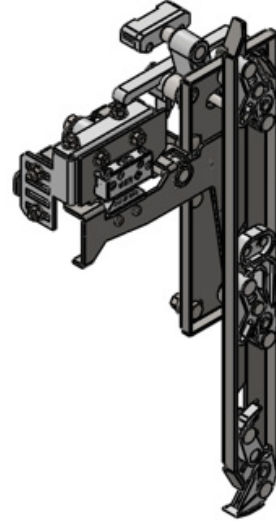

Skate EN 81-20/50 Kilit Kit Sağ
CDRS50LCK02R

Kabin Kapı S50 Skate EN 81-20/50 Kilit Kit Sağ
Car Door S50 Skate EN 81-20/50 Lock Kit Right

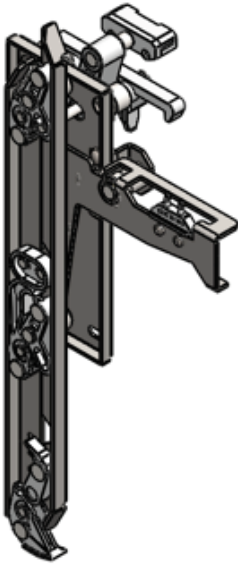

EN 81-20/50 S50 Model Skate Sol
CDRS50SKTL

Kabin Kapı EN 81-20/50 S50 Model Skate Sol
Car Door EN 81-20/50 S50 Model Skate Left

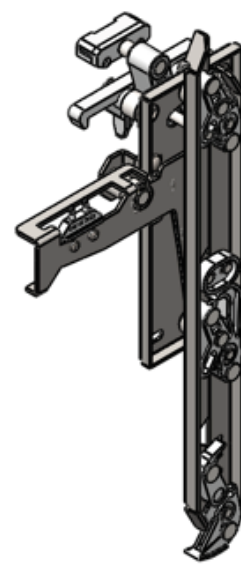

EN 81-20/50 S50 Model Skate Sağ
CDRS50SKTR

Kabin Kapı EN 81-20/50 S50 Model Skate Sağ
Car Door EN 81-20/50 S50 Model Skate Right

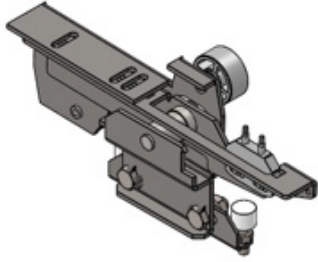
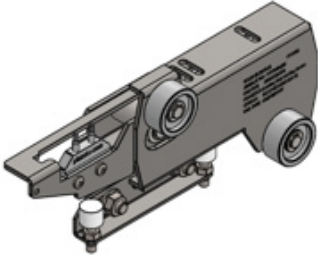
**LDRS50LCK01L**

Kat Kapı Kilit Sol

Landing Door Locking Device Left

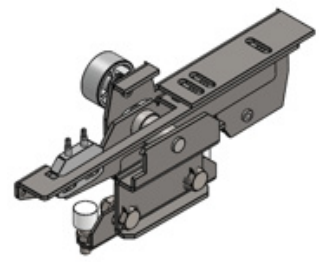
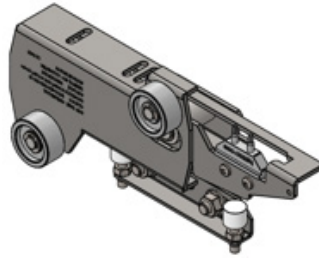
**LDRS50LCK01R**

Kat Kapı Kilit Sağ

Landing Door Locking Device Right

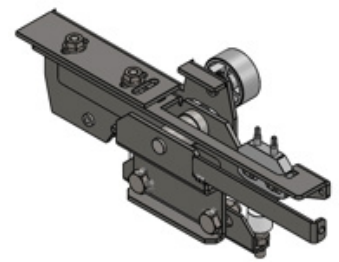
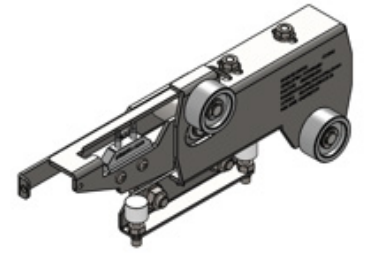
**LDRS50LCK01C**

Kat Kapı Kilit Merkez

Landing Door Locking Device Centre

KAT KAPI 2P
TELESKOPIK
MEKANİZMA
ALUMİNYUM KIZAK
Landing Door 2p
Telescopik Mechanism
Aluminum Guide

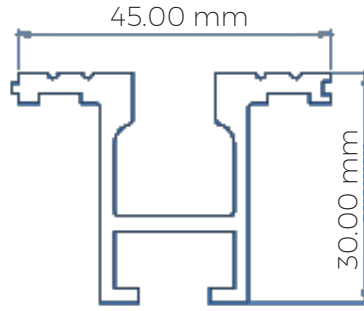

KAT KAPI 2P
MERKEZ
MEKANİZMA
ALUMİNYUM KIZAK
Landing Door 2p
Centre Mechanism
Aluminum Guide

KOD Code	Genişlik Co	Uzunluk Lenght
DR.S50.PRT.131.T.0600	0600	950 mm.
DR.S50.PRT.131.T.0650	0650	1025 mm.
DR.S50.PRT.131.T.0700	0700	1100 mm.
DR.S50.PRT.131.T.0750	0750	1175 mm.
DR.S50.PRT.131.T.0800	0800	1250 mm.
DR.S50.PRT.131.T.0850	0850	1325 mm.
DR.S50.PRT.131.T.0900	0900	1400 mm.
DR.S50.PRT.131.T.1000	1000	1550 mm.
DR.S50.PRT.131.T.1100	1100	1700 mm.
DR.S50.PRT.131.T.1200	1200	1850 mm.
DR.S50.PRT.131.T.1300	1300	2000 mm
DR.S50.PRT.131.T.1400	1400	2150 mm.

KOD Code	Genişlik Co	Uzunluk Lenght
DR.S50.PRT.131.C.0600	0600	1240 mm.
DR.S50.PRT.131.C.0650	0650	1340 mm.
DR.S50.PRT.131.C.0700	0700	1440 mm.
DR.S50.PRT.131.C.0750	0750	1540 mm.
DR.S50.PRT.131.C.0800	0800	1640 mm.
DR.S50.PRT.131.C.0850	0850	1740 mm.
DR.S50.PRT.131.C.0900	0900	1840 mm.
DR.S50.PRT.131.C.1000	1000	2040 mm.
DR.S50.PRT.131.C.1100	1100	2240 mm.
DR.S50.PRT.131.C.1200	1200	2440 mm.
DR.S50.PRT.131.C.1300	1300	2640 mm.
DR.S50.PRT.131.C.1400	1400	2840 mm.

KAT KAPI 2P
TELESKOPİK
MEKANİZMA
YAKINLAŞTIRMA HALATI
Door 2p Telescopic
Mechanism Closing
Rope

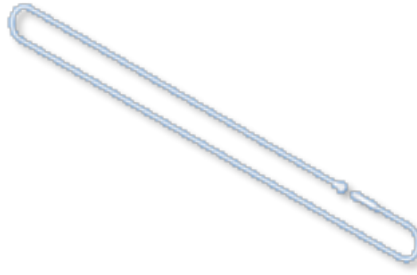

KAT KAPI 2P MERKEZ
MEKANİZMA
YAKINLAŞTIRMA
HALATI
Door 2p Centre
Mechanism Closing
Rope

KOD Code	Genişlik Co	Uzunluk Lenght
DR.S50.ASM.003.T.0600	0600	960 mm.
DR.S50.ASM.003.T.0650	0650	1010 mm.
DR.S50.ASM.003.T.0700	0700	1060 mm.
DR.S50.ASM.003.T.0750	0750	1110 mm.
DR.S50.ASM.003.T.0800	0800	1160 mm.
DR.S50.ASM.003.T.0850	0850	1210 mm.
DR.S50.ASM.003.T.0900	0900	1260 mm.
DR.S50.ASM.003.T.1000	1000	1360 mm.
DR.S50.ASM.003.T.1100	1100	1460 mm.
DR.S50.ASM.003.T.1200	1200	1560 mm.
DR.S50.ASM.003.T.1300	1300	1660 mm.
DR.S50.ASM.003.T.1400	1400	1760 mm.

KOD Code	Genişlik Co	Uzunluk Lenght
DR.S50.ASM.003.C.0600	0600	2920 mm.
DR.S50.ASM.003.C.0650	0650	3020 mm.
DR.S50.ASM.003.C.0700	0700	3120 mm.
DR.S50.ASM.003.C.0750	0750	3220 mm.
DR.S50.ASM.003.C.0800	0800	3320 mm.
DR.S50.ASM.003.C.0850	0850	3420 mm.
DR.S50.ASM.005.C.0900	0900	3520 mm.
DR.S50.ASM.003.C.1000	1000	3720 mm.
DR.S50.ASM.003.C.1100	1100	3920 mm.
DR.S50.ASM.003.C.1200	1200	4120 mm.
DR.S50.ASM.003.C.1300	1300	4320 mm.
DR.S50.ASM.003.C.1400	1400	4520 mm.

KABİN KAPI 2P
TELESKOPİK
OPERATÖR KAYIŞI
Car Door 2p Telescopic
Operator Belt



KABİN KAPI 2P MERKEZ
OPERATÖR KAYIŞI
Car Door 2p Centre
Operator Belt

KOD Code	Genişlik Co	Uzunluk Lenght
CDR.S50.PRT.005.T.0600	0600	1745 mm.
CDR.S50.PRT.005.T.0650	0650	1895 mm.
CDR.S50.PRT.005.T.0700	0700	2045 mm.
CDR.S50.PRT.005.T.0750	0750	2195 mm.
CDR.S50.PRT.005.T.0800	0800	2345 mm.
CDR.S50.PRT.005.T.0850	0850	2495 mm.
CDR.S50.PRT.003.T.0900	0900	2645 mm.
CDR.S50.PRT.003.T.1000	1000	2945 mm.
CDR.S50.PRT.003.T.1100	1100	3245 mm.
CDR.S50.PRT.003.T.1200	1200	3545 mm.
CDR.S50.PRT.003.T.1300	1300	3845 mm.
CDR.S50.PRT.003.T.1400	1400	4145 mm.

KOD Code	Genişlik Co	Uzunluk Lenght
CDR.S50.PRT.005.C.0600	0600	925 mm.
CDR.S50.PRT.005.C.0650	0650	1025 mm.
CDR.S50.PRT.005.C.0700	0700	1125 mm.
CDR.S50.PRT.005.C.0750	0750	1225 mm.
CDR.S50.PRT.005.C.0800	0800	1325 mm.
CDR.S50.PRT.005.C.0850	0850	1425 mm.
CDR.S50.PRT.003.C.0900	0900	1525 mm.
CDR.S50.PRT.003.C.1000	1000	1725 mm.
CDR.S50.PRT.003.C.1100	1100	1925 mm.
CDR.S50.PRT.003.C.1200	1200	2125 mm.
CDR.S50.PRT.003.C.1300	1300	2325 mm.
CDR.S50.PRT.003.C.1400	1400	2525 mm.

since
**19
76**

UYGAR®

Alcı OSB Mah.

2020. Cad. No: 11

Sincan/Ankara 06930

T: +90 312 444 45 18

F: +90 312 502 33 52

1187. Sokak No:1

Ostim-Ankara 06374

T: +90 312 444 45 18

F: +90 312 354 68 83

info@uygar.com.tr

Fabrika

Mağaza

T R U S T T O M O T I O N