

Key features:

- **Advanced Real-Time SCADA and PID Control.**
- **Open Control + Multicontrol + Real-Time Control.**
- **Specialized EDIBON Control Software based on Labview.**
- **National Instruments Data Acquisition board (250 KS/s, kilo samples per second).**
- **Calibration exercises, which are included, teach the user how to calibrate a sensor and the importance of checking the accuracy of the sensors before taking measurements.**
- **Projector and/or electronic whiteboard compatibility allows the unit to be explained and demonstrated to an entire class at one time.**
- **Capable of doing applied research, real industrial simulation, training courses, etc.**
- **Remote operation and control by the user and remote control for EDIBON technical support, are always included.**
- **Totally safe, utilizing 4 safety systems (Mechanical, Electrical, Electronic & Software).**
- **Designed and manufactured under several quality standards.**
- **Optional CAL software helps the user perform calculations and comprehend the results.**
- **This unit has been designed for future expansion and integration. A common expansion is the EDIBON Scada-Net (ESN) System which enables multiple students to simultaneously operate many units in a network.**

**OPEN CONTROL  
+  
MULTICONTROL  
+  
REAL TIME CONTROL**

For more information about Key Features, click here:



ISO 9000: Quality Management (for Design, Manufacturing, Commercialization and After-sales service)



European Union Certificate (total safety)



Certificates ISO 14000 and ECO-Management and Audit Scheme (environmental management)



Worlddidac Quality Charter Certificate and Worlddidac Member

[www.edibon.com](http://www.edibon.com)  
Products  
Products range  
Units  
11.-Chemical Engineering

7 actuators and 10 sensors controlled from any computer, and working simultaneously

**OPEN CONTROL**  
+  
**MULTICONTROL**  
+  
**REAL TIME CONTROL**

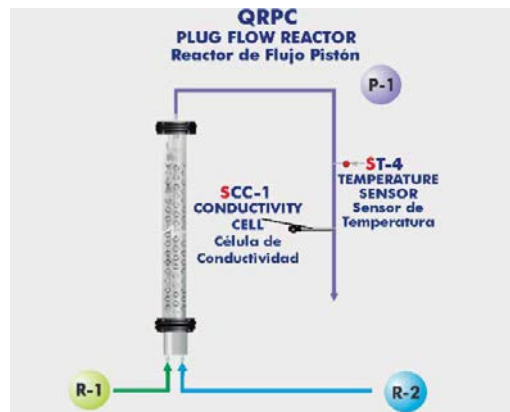
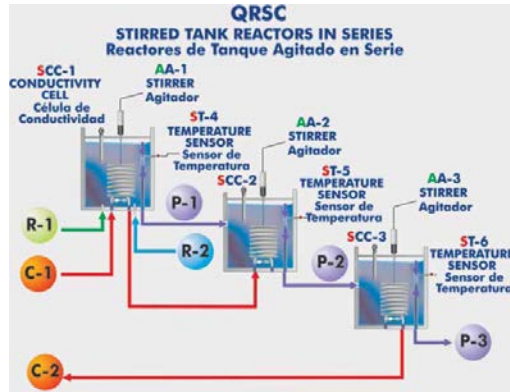
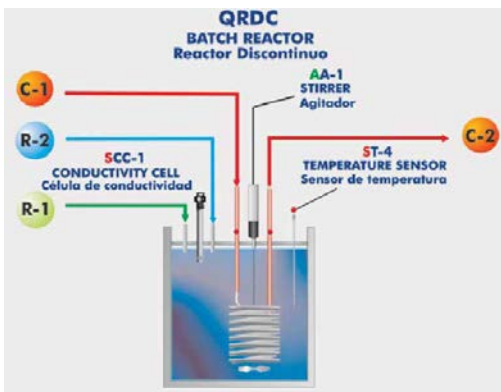
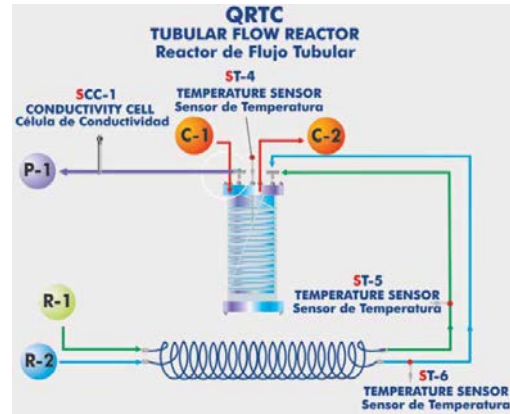
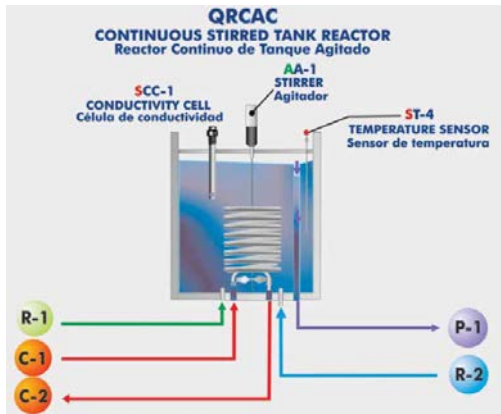
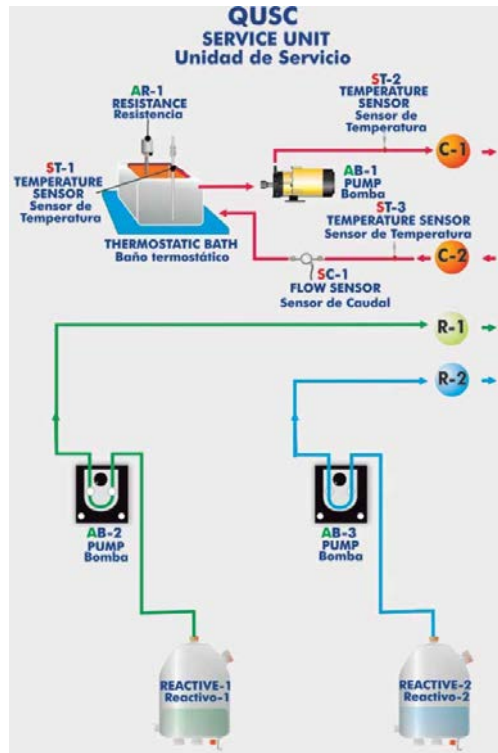

Note: AB= Pump. AR= Heating element. ST= Temperature sensor. SC= Flow sensor. SCC= Conductivity cell. AA= Stirrer.

**Common items for the Chemical Reactors**

**① QUSC. Service Unit:**

This unit is common for the Chemical Reactors, and can work with one or several reactors. Accommodation and exchange system of the reactors, quick and easy to handle. It supplies all the services for the operation of each reactor. Anodized aluminum structure and panels of painted steel. Main metallic elements in stainless steel. Diagram in the front panel with similar distribution to the elements in the real unit. 2 Peristaltic dosing pumps, with variable speed, computer controlled. Flow rate up to 3 l./h. (unit standard disposition). With another disposition, they could reach a flow rate up to 10 l./h. Thermostatic bath, of 6 l. capacity, computer controlled. Temperature PID control of the thermostatic bath. Pump of 3 l./min., to impel the thermostatic water from the bath to the reactor. Flow sensor, range: 0.25-6.5 l./min. 2 Tanks for the reagents, of 1 l. capacity each one, made of Pyrex glass. The control of the reaction is carried out by a conductivity sensor, which allows the reaction evolution parameterization in real time. Three "J" type temperature sensors, one to know the thermostatic bath temperature in a continuous way and two sensors to know the water temperature of the thermostatic bath water inlet and outlet. Quick connectors with shutoff valve that enable an easy coupling of the Service Unit to the chosen reactor. All elements of this unit are chemically resistant.

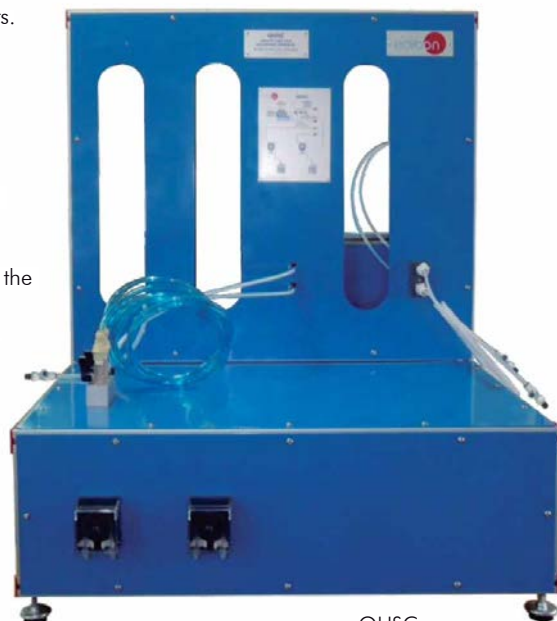

QUSC

**② QRC/CIB. Control Interface Box:**

This control interface is common for the Chemical Reactors and can work with one or several reactors. The Control Interface Box is part of the SCADA system. **Control interface box with process diagram in the front panel** and with the same distribution that the different elements located in the unit, for an easy understanding by the student. All sensors, with their respective signals, are properly manipulated from -10V. to +10V. computer output. Sensors connectors in the interface have different pines numbers (from 2 to 16), to avoid connection errors. Single cable between the control interface box and computer. **The unit control elements are permanently computer controlled**, without necessity of changes or connections during the whole process test procedure. **Simultaneous visualization in the computer of all parameters involved in the process.** **Calibration of all sensors involved in the process.** **Real time curves representation about system responses.** Storage of all the process data and results in a file. Graphic representation, in real time, of all the process/system responses. **All the actuators' values can be changed at any time from the keyboard** allowing the analysis about curves and responses of the whole process. All the actuators and sensors values and their responses are displayed on only one screen in the computer. **Shield and filtered signals to avoid external interferences.** **Real time PID control with flexibility of modifications from the computer keyboard of the PID parameters, at any moment during the process.** Real time PID and on/off control for pumps, compressors, resistances, control valves, etc. **Real time PID control for parameters involved in the process simultaneously.** Proportional control, integral control and derivative control, based on the real PID mathematical formula, by changing the values, at any time, of the three control constants (proportional, integral and derivative constants). **Open control** allowing modifications, at any moment and in real time, of parameters involved in the process simultaneously. Possibility of automatization of the actuators involved in the process. **Three safety levels, one mechanical in the unit, another electronic in the control interface and the third one in the control software.**



QRC/CIB

**③ DAB. Data Acquisition Board:**

This board is common for the Chemical Reactors. The Data Acquisition board is part of the SCADA system. PCI Express Data acquisition board (National Instruments) to be placed in a computer slot. Bus PCI Express. **Analog input:** Number of channels= 16 single-ended or 8 differential. **Resolution= 16 bits**, 1 in 65536. **Sampling rate up to: 250 KS/s (kilo samples per second).** Input range (V) = ±10 V. Data transfers=DMA, interrupts, programmed I/O. DMA channels=6. **Analog output:** Number of channels=2. **Resolution= 16 bits**, 1 in 65536. Maximum output rate up to: 900 KS/s. Output range(V) = ±10 V. Data transfers=DMA, interrupts, programmed I/O. **Digital Input/Output:** Number of channels=24 inputs/outputs. DO or DI Sample Clock frequency: 0 to 100 MHz. Timing: **Counter/timers=4.** Resolution: Counter/timers: 32 bits.



DAB

Continue...

## ④ Chemical Reactors

### ④.1 **QRCAC. Continuous Stirred Tank Reactor:**

Small scale Continuous Stirred Tank Reactor, computer controlled, designed to demonstrate the behaviour of a reactor used for homogeneous reactions liquid-liquid.

Anodized aluminum structure and panel of painted steel.

Main metallic elements in stainless steel.

Diagram in the front panel with similar distribution to the elements in the real unit.

Reactor body made of borosilicate glass, with a maximum capacity of 2 l., specially designed to work in continuous. It also allows batch operation.

Adjustable volume from 0.4 to 1.5 l.

Stainless steel heat transfer coil (5 loops of 60 mm of diameter) and a baffle (removable).

Stirring system with speed control and indication, computer controlled. Stirrer range: 0-220 rpm.

Reactor lip with connectors for the appropriate sensors.

Temperature sensor "J" type to control the temperature into the reactor.

Conductivity cell to control the reaction. Measurement range up to 20 mS.

Quick connectors with shutoff valve that enable an easy coupling of the reactor to the Service Unit.

All the elements of this unit are chemically resistant.

This unit is supplied with 8 manuals: Required Services, Assembly and Installation, Interface and Control Software, Starting-up, Safety, Maintenance, Calibration & Practices Manuals.

Computer Control Software:

**Computer Control+Data Acquisition+Data Management Software for Continuous Stirred Tank Reactor (QRCAC).**

**The three softwares are part of the SCADA system.**

Compatible with actual Windows operating systems.

Graphic and intuitive simulation of the process on the computer screen.

**Compatible with the industry standards.**

Registration and visualization of all process variables in an automatic and simultaneous way.

**Flexible, open and multicontrol software**, developed with actual windows graphic systems, acting simultaneously on all process parameters.

**Analog and digital PID control.**

**PID menu and set point selection required in the whole work range.**

**Management, processing, comparison and storage of data.**

**Sampling velocity up to 250 KS/s (kilo samples per second).**

**Calibration system for the sensors involved in the process.**

**It allows the registration of the alarms state and the graphic representation in real time.**

Comparative analysis of the obtained data, after the process and modification of the conditions during the process.

**Open software, allowing the teacher to modify texts, instructions. Teacher's and student's passwords** to facilitate the teacher's control on the student, and allowing the access to different work levels.

**This unit allows the 30 students of the classroom to visualize simultaneously all the results and the manipulation of the unit, during the process, by using a projector or an electronic whiteboard.**



QRCAC

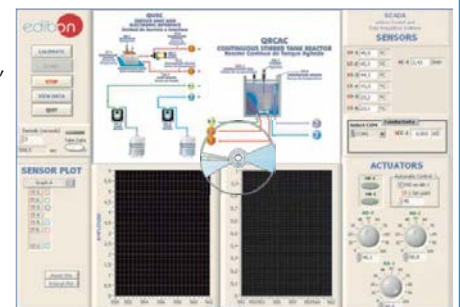

④ **Chemical Reactors** (continuation)④.2 **QRTC. Tubular Flow Reactor:**

Reactor composed by a continuous tube where the reagents are introduced through the coil end and the products are obtained through the inverse end. Into it, a continuous reagent mix is produced, so the composition will be different at each point. This type of reactors are industrially used for homogeneous reactions liquid-liquid, generally in isothermal conditions.

With this small scale reactor, computer controlled, the behaviour of this type of reactors used at industrial level can be observed.

Anodized aluminum structure and panel of painted steel.

Main metallic elements in stainless steel.

Diagram in the front panel with similar distribution to the elements in the real unit.

Tubular flow reactor of volume 0.4 l. Coil shaped. Placed into an acrylic vessel through which the cooling or heating medium circulates. Coil length of 20 m.

Electric pre-heater of 12 loops, and loop diameter of 70 mm approx., for the two reagents feed lines. It is placed before the mix and the currents inlet to the reactor.

Temperature controlled by water jacketed.

Two temperature sensors "J" type to know the reagents outlet temperature from the pre-heater.

Conductivity cell to control the reaction. Measurement range up to 20 mS.

Reactor lip with connectors for the appropriate sensors.

Quick connectors with shutoff valve that enable an easy coupling of the reactor to the Service Unit.

All the elements of this unit are chemically resistant.

This unit is supplied with 8 manuals: Required Services, Assembly and Installation, Interface and Control Software, Starting-up, Safety, Maintenance, Calibration & Practices Manuals.

Computer Control Software:

**Computer Control+Data Acquisition+Data Management Software for Tubular Flow Reactor (QRTC).**

**The three softwares are part of the SCADA system.**

Compatible with actual Windows operating systems.

Graphic and intuitive simulation of the process on the computer screen.

**Compatible with the industry standards.**

Registration and visualization of all process variables in an automatic and simultaneous way.

**Flexible, open and multicontrol software**, developed with actual windows graphic systems, acting simultaneously on all process parameters.

**Analog and digital PID control.**

**PID menu and set point selection required in the whole work range.**

**Management, processing, comparison and storage of data.**

**Sampling velocity up to 250 KS/s (kilo samples per second).**

**Calibration system for the sensors involved in the process.**

**It allows the registration of the alarms state and the graphic representation in real time.**

Comparative analysis of the obtained data, after the process and modification of the conditions during the process.

**Open software, allowing the teacher to modify texts, instructions. Teacher's and student's passwords** to facilitate the teacher's control on the student, and allowing the access to different work levels.

**This unit allows the 30 students of the classroom to visualize simultaneously all the results and the manipulation of the unit, during the process, by using a projector or an electronic whiteboard.**



QRTC

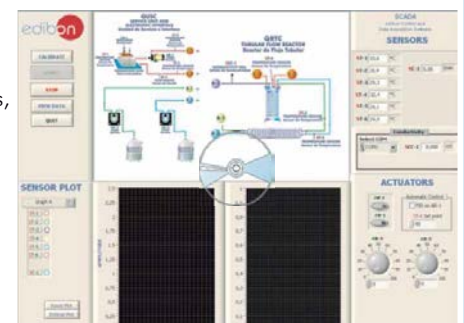

Continue...

④ **Chemical Reactors** (continuation)④.3 **QRDC. Batch Reactor:**

Small scale Bath Reactor, computer controlled, designed for the kinetic study of homogeneous reactions liquid-liquid, both in adiabatic conditions and in isothermal conditions.

Anodized aluminum structure and panel of painted steel.

Main metallic elements in stainless steel.

Diagram in the front panel with similar distribution to the elements in the real unit.

The reactor body is an isolated vessel with a stainless steel external casing. The working volume is 1 l.

Heat transfer coil made of stainless steel and reactor baffle, of 5 loops of 60 mm of diameter. The tube internal diameter is of 6 mm and the external one is of 8 mm.

Stirring system with speed control and indication, computer controlled. Stirrer range: 0-220 rpm.

Temperature sensor "J" type to control the temperature into the reactor.

Conductivity cell to control the reaction. Measurement range up to 20 mS.

Reactor lip with connectors for the appropriate sensors.

Quick connectors with shutoff valve that enable an easy coupling of the reactor to the Service Unit.

All the elements of this unit are chemically resistant.

This unit is supplied with 8 manuals: Required Services, Assembly and Installation, Interface and Control Software, Starting-up, Safety, Maintenance, Calibration & Practices Manuals.

Computer Control Software:

**Computer Control+Data Acquisition+Data Management Software for Batch Reactor (QRDC).**

**The three softwares are part of the SCADA system.**

Compatible with actual Windows operating systems.

Graphic and intuitive simulation of the process on the computer screen.

**Compatible with the industry standards.**

Registration and visualization of all process variables in an automatic and simultaneous way.

**Flexible, open and multicontrol software**, developed with actual windows graphic systems, acting simultaneously on all process parameters.

**Analog and digital PID control.**

**PID menu and set point selection required in the whole work range.**

**Management, processing, comparison and storage of data.**

**Sampling velocity up to 250 KS/s (kilo samples per second).**

**Calibration system for the sensors involved in the process.**

**It allows the registration of the alarms state and the graphic representation in real time.**

Comparative analysis of the obtained data, after the process and modification of the conditions during the process.

**Open software, allowing the teacher to modify texts, instructions. Teacher's and student's passwords** to facilitate the teacher's control on the student, and allowing the access to different work levels.

**This unit allows the 30 students of the classroom to visualize simultaneously all the results and the manipulation of the unit, during the process, by using a projector or an electronic whiteboard.**



QRDC

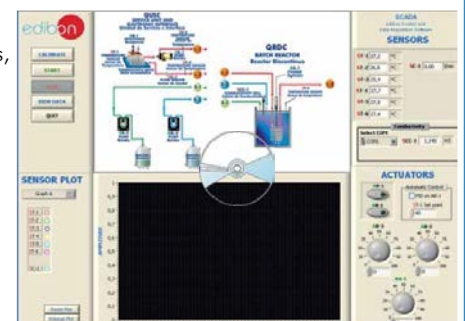

④ **Chemical Reactors** (continuation)④.4 **QRSC. Stirred Tank Reactors in Series:**

The stirred tank reactors in series are used to increase the reagents conversion referred to an only reactor and so obtain product with higher purity.

Anodized aluminum structures and panels of painted steel.

Main metallic elements in stainless steel.

Diagram in the front panel with similar distribution to the elements in the real unit.

3 Continuous stirred tank reactors connected in series, computer controlled.

The three reactors have different height to let product from the first reactor go to the second one and so on.

Reactors body made of pyrex glass with a volume of 2 l. Adjustable volume from 0.4 to 1.5 l.

Each reactor is fitted with a conductivity cell. Measurement range up to 20 mS.

Each reactor has a stirrer with variable speed, computer controlled.

The two reagent vessels and the two variable speed dosing pumps (at the QUSC Service Unit) feed reagents into the first reactor in line.

A dead-time residence coil can also be attached to the exit of the last reactor in the series.

3 Temperature sensors "J" type, one in each reactor.

Quick connectors with shutoff valve that enable an easy coupling of the reactors to the Service Unit.

All the elements of this unit are chemically resistant.

This unit is supplied with 8 manuals: Required Services, Assembly and Installation, Interface and Control Software, Starting-up, Safety, Maintenance, Calibration & Practices Manuals.

Computer Control Software:

**Computer Control+Data Acquisition+Data Management Software for Stirred Tank Reactors in Series (QRSC).**

**The three softwares are part of the SCADA system.**

Compatible with actual Windows operating systems.

Graphic and intuitive simulation of the process on the computer screen.

**Compatible with the industry standards.**

Registration and visualization of all process variables in an automatic and simultaneous way.

**Flexible, open and multicontrol software**, developed with actual windows graphic systems, acting simultaneously on all process parameters.

**Analog and digital PID control.**

**PID menu and set point selection required in the whole work range.**

**Management, processing, comparison and storage of data.**

**Sampling velocity up to 250 KS/s (kilo samples per second).**

**Calibration system for the sensors involved in the process.**

**It allows the registration of the alarms state and the graphic representation in real time.**

Comparative analysis of the obtained data, after the process and modification of the conditions during the process.

**Open software, allowing the teacher to modify texts, instructions. Teacher's and student's passwords** to facilitate the teacher's control on the student, and allowing the access to different work levels.

**This unit allows the 30 students of the classroom to visualize simultaneously all the results and the manipulation of the unit, during the process, by using a projector or an electronic whiteboard.**

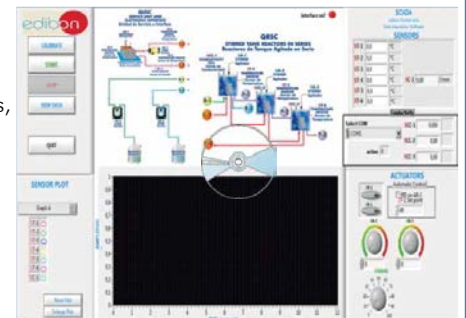
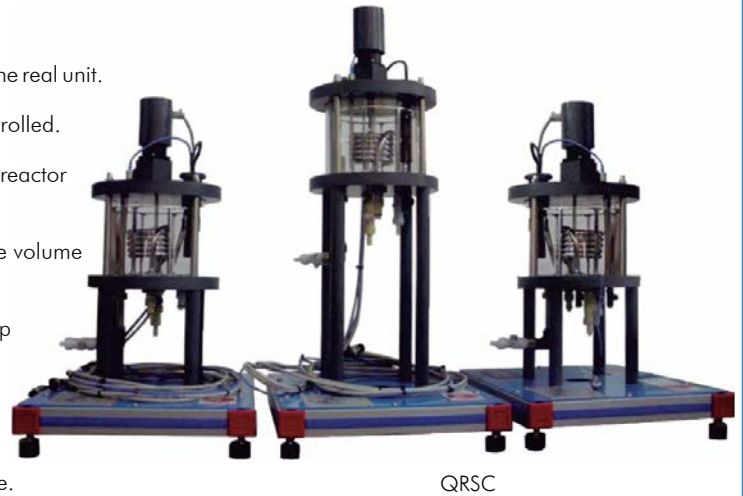

④ **Chemical Reactors** (continuation)④.5 **QRLC. Laminar Flow Reactor:**

Small scale Laminar Flow Reactor, computer controlled, designed to demonstrate the flow pattern characterisation and the steady state conversion in a tubular reactor.

Anodized aluminum structure and panels of painted steel.

Main metallic elements in stainless steel.

Diagram in the front panel with similar distribution to the elements in the real unit.

Working volume: 400 ml.

Laminar flow reactor constituted by a glass column of 400 ml and 1000 mm long, including 2 diffusers packed with glass balls of 3 mm.

At the bottom of the column a premixer provides a complete mixing of the reagents entering the reactor and improves the flow distribution.

The reactor refrigeration jacket keeps its contents at a constant temperature to keep the laminar flow conditions.

1 Temperature sensor "J" type.

Conductivity cell to control the reaction. Measurement range up to 20 mS.

Quick connectors with shutoff valve that enable an easy coupling of the reactor to the Service Unit.

All the elements of this unit are chemically resistant.

This unit is supplied with 8 manuals: Required Services, Assembly and Installation, Interface and Control Software, Starting-up, Safety, Maintenance, Calibration & Practices Manuals.

Computer Control Software:

**Computer Control+Data Acquisition+Data Management Software for Laminar Flow Reactor (QRLC).**

**The three softwares are part of the SCADA system.**

Compatible with actual Windows operating systems.

Graphic and intuitive simulation of the process on the computer screen.

**Compatible with the industry standards.**

Registration and visualization of all process variables in an automatic and simultaneous way.

**Flexible, open and multicontrol software**, developed with actual windows graphic systems, acting simultaneously on all process parameters.

**Analog and digital PID control.**

**PID menu and set point selection required in the whole work range.**

**Management, processing, comparison and storage of data.**

**Sampling velocity up to 250 KS/s (kilo samples per second).**

**Calibration system for the sensors involved in the process.**

**It allows the registration of the alarms state and the graphic representation in real time.**

Comparative analysis of the obtained data, after the process and modification of the conditions during the process.

**Open software, allowing the teacher to modify texts, instructions. Teacher's and student's passwords** to facilitate the teacher's control on the student, and allowing the access to different work levels.

**This unit allows the 30 students of the classroom to visualize simultaneously all the results and the manipulation of the unit, during the process, by using a projector or an electronic whiteboard.**



QRLC

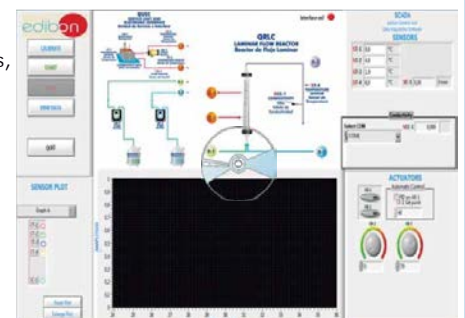

Continue...



④ **Chemical Reactors** (continuation)④.6 **QRPC. Plug Flow Reactor:**

Small scale Plug Flow Reactor, computer controlled, designed to demonstrate the flow pattern characterisation and the steady state conversion in a tubular reactor with axial dispersion.

Working volume: 1 l.

Anodized aluminum structure and panels of painted steel.

Main metallic elements in stainless steel.

Diagram in the front panel with similar distribution to the elements in the real unit.

Plug reactor constituted by a glass column of 1 l. and 1100 mm long, packed with 3 mm diameter glass balls.

At the bottom of the column a premixer provides a complete mixing of the reagents entering the reactor and improves the flow distribution.

The unit uses a 6 ways injection valve, which allows either the feeding of reagents in a continuous way or the possibility to carry out pulse and step changes to characterization of the flow pattern.

1 Temperature sensor "J" type.

Conductivity cell to control the reaction. Measurement range up to 20 mS.

Quick connectors with shutoff valve that enable an easy coupling of the reactor to the Service Unit.

All the elements of this unit are chemically resistant.

This unit is supplied with 8 manuals: Required Services, Assembly and Installation, Interface and Control Software, Starting-up, Safety, Maintenance, Calibration & Practices Manuals.

Computer Control Software:

**Computer Control+ Data Acquisition+ Data Management Software for Plug Flow Reactor (QRPC).**

**The three softwares are part of the SCADA system.**

Compatible with actual Windows operating systems.

Graphic and intuitive simulation of the process on the computer screen.

**Compatible with the industry standards.**

Registration and visualization of all process variables in an automatic and simultaneous way.

**Flexible, open and multicontrol software**, developed with actual windows graphic systems, acting simultaneously on all process parameters.

**Analog and digital PID control.**

**PID menu and set point selection required in the whole work range.**

**Management, processing, comparison and storage of data.**

**Sampling velocity up to 250 KS/s (kilo samples per second).**

**Calibration system for the sensors involved in the process.**

**It allows the registration of the alarms state and the graphic representation in real time.**

Comparative analysis of the obtained data, after the process and modification of the conditions during the process.

**Open software, allowing the teacher to modify texts, instructions. Teacher's and student's passwords** to facilitate the teacher's control on the student, and allowing the access to different work levels.

**This unit allows the 30 students of the classroom to visualize simultaneously all the results and the manipulation of the unit, during the process, by using a projector or an electronic whiteboard.**



QRPC

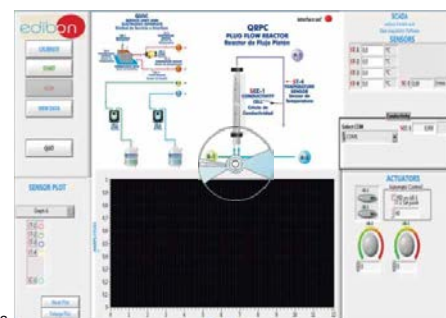

⑤ **Cables and Accessories**, for normal operation.

⑥ **Manuals:** This trainer is **supplied with 8 manuals for each Chemical Reactor:** Required Services, Assembly and Installation, Interface and Control Software, Starting-up, Safety, Maintenance, Calibration & Practices Manuals.

Some Practical Possibilities of the Trainer:**Practices to be done with the Continuous Stirred Tank Reactor (QRCAC):**

- 1.- Determination of the ionic conductivities.
  - 2.- Batch operation. Obtaining of the reaction order respect to ethyl-acetate. Initial velocity method.
  - 3.- Batch operation. Obtaining of the reaction order respect to sodium hydroxide. Initial velocity method.
  - 4.- Batch operation. Velocity Constant Computation. Constant sodium hydroxide initial concentration.
  - 5.- Batch operation. Velocity Constant Computation. Constant ethyl-acetate initial concentration.
  - 6.- Velocity equation formulation.
  - 7.- Batch operation. Variation of the kinetic constant with temperature. Arrhenius Equation.
  - 8.- Batch operation. Theoretical and experimental conversion comparative. Deviation from ideality.
  - 9.- Batch operation. Mixture effects.
  - 10.- Continuous operation.
  - 11.- Continuous operation. Mixture effects.
  - 12.- Conductivity measurement system: conductimeter.
  - 13.- Variation of conversion with residence time.
  - 14.- Residence time distribution.
  - 15.- Determination of the reaction rate constant.
- Additional practical possibilities:
- 16.- Sensors calibration.

**Practices to be done with the Tubular Flow Reactor (QRTC):**

- 17.- Analysis of reagents and products.
  - 18.- Ionic conductivities determination.
  - 19.- Theoretical conversion of the tubular reactor.
  - 20.- Experimental determination of the conversion of the tubular reactor.
  - 21.- Dependence of the residence time.
  - 22.- Determination of the reaction order.
  - 23.- Dependence of the speed constant and the conversion with the temperature.
  - 24.- Conductivity measurement system: conductimeter.
  - 25.- Complete emptying of the unit.
  - 26.- Determination of the reaction rate constant.
- Additional practical possibilities:
- 27.- Sensors calibration.

**Practices to be done with the Batch Reactor (QRDC):**

- 28.- Determination of the ionic conductivities.
  - 29.- Batch operation. Calculation of the order of the reaction referred to the ethyl-acetate. Initial velocity method.
  - 30.- Batch operation. Determination of the order of the reaction referred to the sodium hydroxide. Initial velocity method.
  - 31.- Batch operation. Determination of the speed constant, the initial concentration of the sodium hydroxide is constant.
  - 32.- Batch operation. Determination of the speed constant, the initial concentration of the ethyl acetate is constant.
  - 33.- Formulation of the speed equation.
  - 34.- Batch operation. Variation of the kinetic constant when the temperature is not constant: Arrhenius equation.
  - 35.- Batch operation. Comparison of the theoretical and the experimental conversion: Deviation from the ideality.
  - 36.- Calculation of the heat transference coefficient of the coil.
  - 37.- Calculation of the hydrolysis reaction enthalpy.
  - 38.- Batch operation. Mixture effects.
  - 39.- Conductivity measurement system: conductimeter.
- Additional practical possibilities:
- 40.- Sensors calibration.

**Practices to be done with Stirred Tank Reactors in Series (QRSC):**

- 41.- Investigation of dynamic behaviour of stirred tank reactors in series.
- 42.- Determination of the ionic conductivities.

- 43.- Influence of flow rate.
  - 44.- Work with just one reactor in continuous.
  - 45.- Work with just one reactor in continuous with mixture effects.
  - 46.- Work with 3 reactors in continuous.
  - 47.- Effect of step input change.
  - 48.- Response to an impulse change.
  - 49.- Investigation of time constant using dead time coil.
- Additional practical possibilities:
- 50.- Sensors calibration.

**Practices to be done with the Laminar Flow Reactor (QRLC):**

- 51.- Determination of the residence time distribution of the reactor.
  - 52.- Effect of flow rate and feed concentration on the determination of flow pattern.
  - 53.- Steady state conversion for a reaction with laminar flow.
  - 54.- Effect of flow rate and feed concentration on the steady state conversion.
  - 55.- Demonstration of the flow pattern in the reactor and comparison with the theoretical model.
  - 56.- Effect of the temperature on the laminar flow characterisation.
  - 57.- Determination of the steady state conversion of a second order reaction.
  - 58.- Flow pattern characterisation in a laminar flow reactor.
  - 59.- Conductivity measurement system: conductimeter.
- Additional practical possibilities:
- 60.- Sensors calibration.

**Practices to be done with Plug Flow Reactor (QRPC):**

- 61.- Determination of the residence time distribution of the reactor.
  - 62.- Effect of flow rate and feed concentration on the determination of flow pattern.
  - 63.- Study of the reactor response to different perturbations: step and pulse change.
  - 64.- Effect of flow rate and feed concentration on the steady state conversion.
  - 65.- Demonstration of the flow pattern in the reactor and comparison with the theoretical model.
  - 66.- Determination of the steady state conversion of a second order reaction.
  - 67.- Understanding the principles of tracer techniques in flow pattern characterisation.
  - 68.- Conductivity measurement system: conductimeter.
- Additional practical possibilities:
- 69.- Sensors calibration.

Other possibilities to be done with this system:

- 70.- Many students view results simultaneously.  
To view all results in real time in the classroom by means of a projector or an electronic whiteboard.
- 71.- Open Control, Multicontrol and Real Time Control.  
This unit allows intrinsically and/or extrinsically to change the span, gains; proportional, integral, derivate parameters; etc, in real time.
- 72.- The Computer Control System with SCADA and PID Control allow a real industrial simulation.
- 73.- This unit is totally safe as uses mechanical, electrical and electronic, and software safety devices.
- 74.- This unit can be used for doing applied research.
- 75.- This unit can be used for giving training courses to Industries even to other Technical Education Institutions.
- 76.- Control of the unit process through the control interface box without the computer.
- 77.- Visualization of all the sensors values used in the unit process.  
- By using PLC-PI additional 19 more exercises can be done.  
- Several other exercises can be done and designed by the user.

## REQUIRED SERVICES

- Electrical supply: single phase, 220V/50Hz or 110V/60 Hz.
- Water supply and drainage.
- Computer (PC).

## DIMENSIONS & WEIGHTS

QUSC Unit:	-Dimensions: 800 x 800 x 1000 mm. approx. (31.49 x 31.49 x 39.37 inches approx.).
	-Weight: 50 Kg. approx. (110 pounds approx.).
QRAC Unit:	-Dimensions: 330 x 330 x 500 mm. approx. (12.99 x 12.99 x 19.68 inches approx.).
	-Weight: 10 Kg. approx. (22 pounds approx.).
QRTC Unit:	-Dimensions: 330 x 350 x 500 mm. approx. (12.99 x 13.78 x 19.68 inches approx.).
	-Weight: 15 Kg. approx. (33 pounds approx.).
QRDC Unit:	-Dimensions: 330 x 330 x 500 mm. approx. (12.99 x 12.99 x 19.68 inches approx.).
	-Weight: 10 Kg. approx. (22 pounds approx.).
QRSC Unit:	-Dimensions: 950 x 450 x 600 mm. approx. (37.40 x 17.71 x 23.62 inches approx.).
	-Weight: 35 Kg. approx. (77 pounds approx.).
QRLC Unit:	-Dimensions: 330 x 330 x 1490 mm. approx. (12.99 x 12.99 x 58.66 inches approx.).
	-Weight: 25 Kg. approx. (55 pounds approx.).
QRPC Unit:	-Dimensions: 330 x 330 x 1350 mm. approx. (12.99 x 12.99 x 53.15 inches approx.).
	-Weight: 25 Kg. approx. (55 pounds approx.).
Control Interface Box:	-Dimensions: 490 x 330 x 310 mm. approx. (19.29 x 12.99 x 12.20 inches approx.).
	-Weight: 10 Kg. approx. (22 pounds approx.).

## RECOMMENDED ACCESSORIES

- Chemical reagents: ethyl acetate, sodium acetate and sodium hydroxide.
- Laboratory materials as: burettes, test tubes, glasses, balance and a 1 l. glass flask.

## AVAILABLE VERSIONS

Offered in this catalogue:

- QRC. Computer Controlled Chemical Reactors Trainer.

Offered in other catalogues:

- QR. Chemical Reactors Trainer.
- QRQC. Computer Controlled Chemical Reactors Training System.

SCADA and PID Control

Initial Screen

Initial screen where the type of reactor is selected.



Continuous Stirred Tank Reactor (QRCAC) Main Screen

**QRCAC CONTINUOUS STIRRED TANK REACTOR**  
Reactor Continuo de Tanque Agitado

**SENSORS**

ST-1	45,0	°C
ST-2	45,3	°C
ST-3	44,3	°C
ST-4	43,5	°C
ST-5	23,2	°C
ST-6	23,1	°C
SCC-1	2,43	µm/s

**ACTUATORS**

AR-1: Automatic Control  PID on AR-1  
ST-1 Set point: 45

AB-3: 46,1  
AB-2: 50,8  
AA-1: 98,8

Note: AB= Pump. AR= Heating element. ST= Temperature sensor. SC= Flow sensor. SCC= Conductivity sensor. AA= Stirrer.

Continue...

Tubular Flow Reactor (QRTC) Main Screen

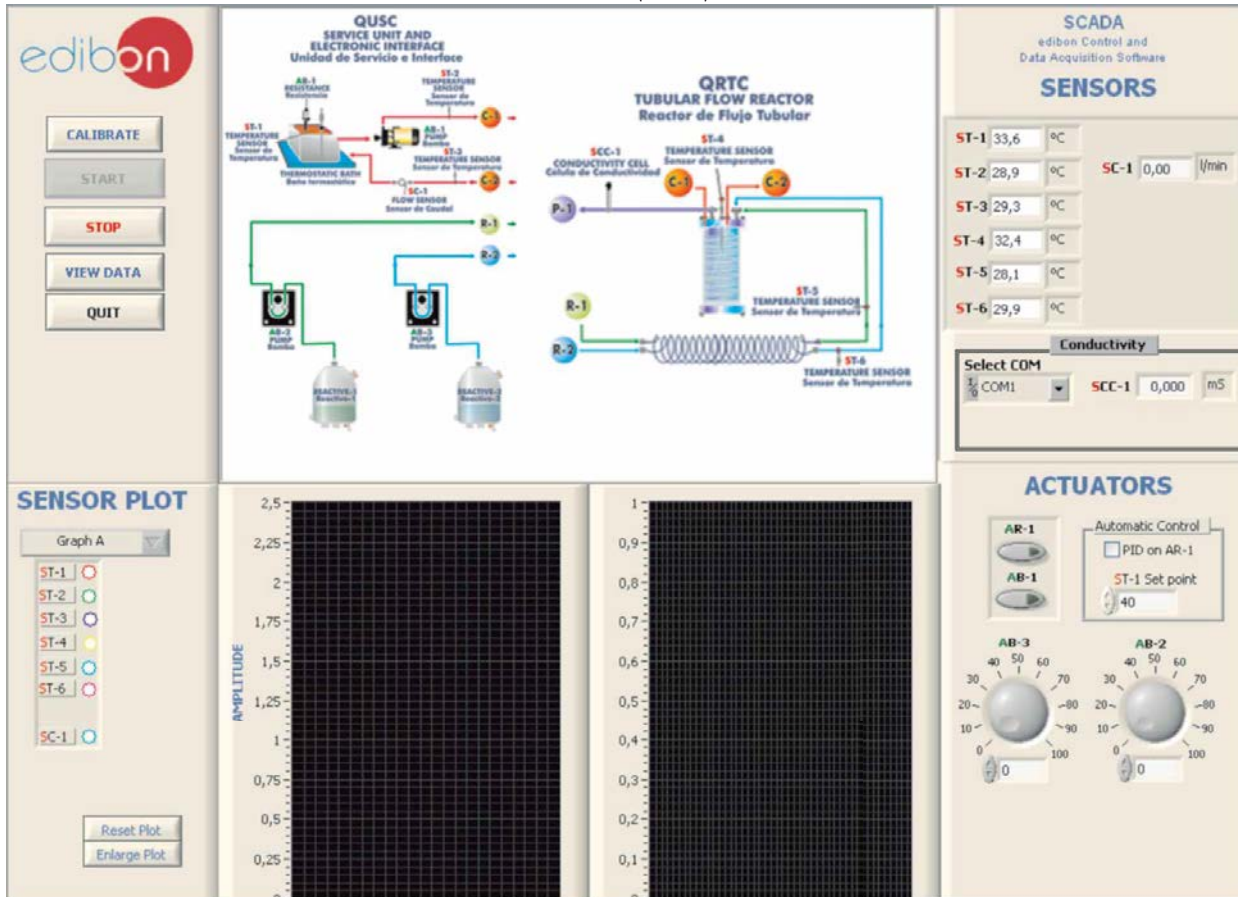

Batch Reactor (QRDC) Main Screen

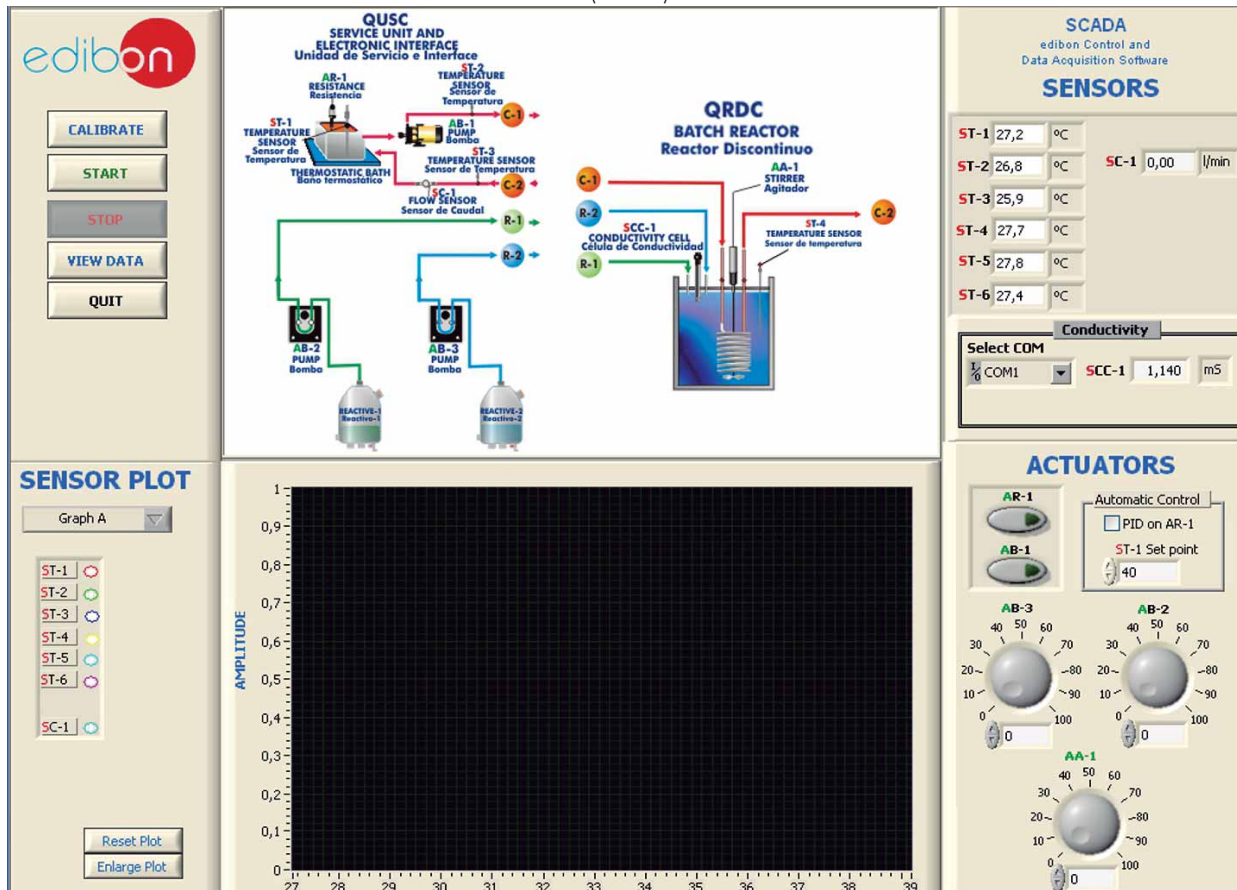

Note: AB= Pump. AR= Heating element. ST= Temperature sensor. SC= Flow sensor. SCC= Conductivity sensor. AA= Stirrer.

Continue...

SCADA and PID Control

Stirred Tank Reactors in Series (QRSC) Main Screen

Laminar Flow Reactor (QRLC) Main Screen

Note: AB= Pump. AR= Heating element. ST= Temperature sensor. SC= Flow sensor. SCC= Conductivity sensor. AA= Stirrer.

Continue...

SCADA and PID Control

Plug Flow Reactor (QRPC) Main Screen

Note: AB= Pump. AR= Heating element. ST= Temperature sensor. SC= Flow sensor. SCC= Conductivity sensor.

Software for Sensors Calibration

Example of screens

Reference Select	Sensors	Volts	Calibrated	Err (%)
<input checked="" type="checkbox"/>	ST-1	0,2046	22,3821	0,82
<input checked="" type="checkbox"/>	ST-2	0,2292	23,483	0,28
<input checked="" type="checkbox"/>	ST-3	0,2363	23,1522	0,05
<input checked="" type="checkbox"/>	ST-4	0,2301	23,2113	0,01
<input type="checkbox"/>		0,1527	13,1629	10,04
<input type="checkbox"/>	SCC-1	5,2792	172,5164	149,31
<input type="checkbox"/>		-0,2362	-22,6609	45,87
<input type="checkbox"/>	SC-1	-0,1774	0,0319629	23,17
<input type="checkbox"/>		-0,2681	-60,4623	83,67
<input type="checkbox"/>		-0,2251	0,4208	22,78
<input type="checkbox"/>		-0,2529	-0,2529	23,46
<input type="checkbox"/>		-0,2063	-0,1178	23,32
<input type="checkbox"/>		-0,2581	-226,9384	250,14
<input type="checkbox"/>		-0,3634	-0,3634	23,57
<input type="checkbox"/>		-0,275	-0,275	23,46
<input type="checkbox"/>		-0,2085	-0,2085	23,41

## SOME TYPICAL RESULTS

Example of practices results where a reactive conductivity (SCC) variation is represented according to the temperature variation into the reactor (ST4)

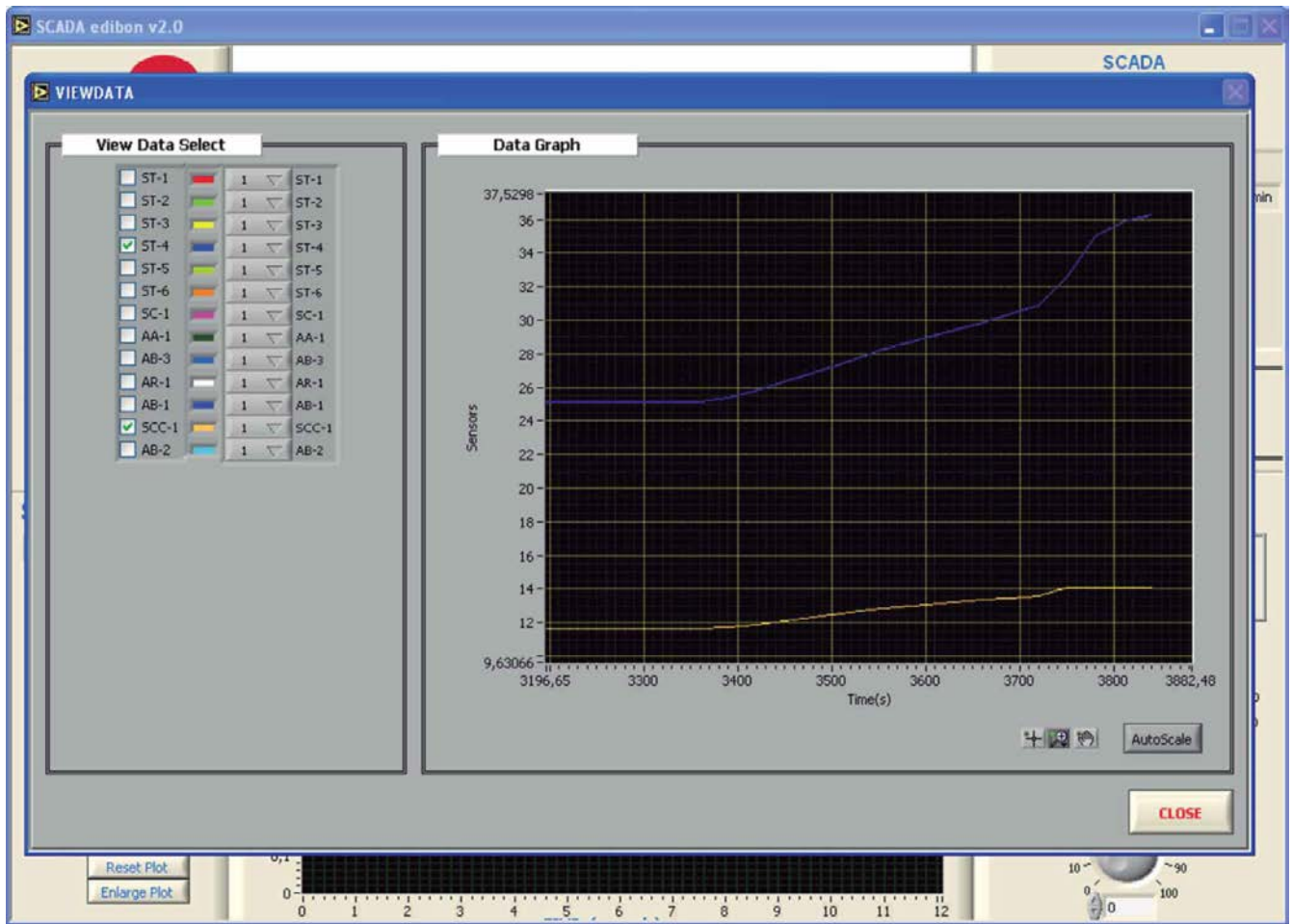



### ⑦ PLC. Industrial Control using PLC (it includes PLC-PI Module plus PLC-SOF Control Software):

#### -PLC-PI. PLC Module:

This unit is common for Chemical Reactors and can work with one or several reactors.

Metallic box.

Circuit diagram in the module front panel.

Front panel:

#### Digital inputs(X) and Digital outputs (Y) block:

16 Digital inputs, activated by switches and 16 LEDs for confirmation (red).

14 Digital outputs (through SCSI connector) with 14 LEDs for message (green).

#### Analog inputs block:

16 Analog inputs (-10 V. to + 10 V.) (through SCSI connector).

#### Analog outputs block:

4 Analog outputs (-10 V. to + 10 V.) (through SCSI connector).

#### Touch screen:

High visibility and multiple functions. Display of a highly visible status. Recipe function. Bar graph function. Flow display function. Alarm list.

Multi language function. True type fonts.

Back panel:

Power supply connector. Fuse 2A. RS-232 connector to PC. USB 2.0 connector to PC.

Inside:

Power supply outputs: 24 Vdc, 12 Vdc, -12 Vdc, 12 Vdc variable.

#### Panasonic PLC:

High-speed scan of 0.32  $\mu$ sec. for a basic instruction.

Program capacity of 32 Ksteps, with a sufficient comment area.

Power supply input (100 to 240 V AC).

DC input: 16 (24 VDC).

Relay output: 14.

High-speed counter.

Multi-point PID control.

#### Digital inputs/outputs and analog inputs/outputs Panasonic modules.

Communication RS232 wire to computer (PC).

Dimensions: 490 x 330 x 310 mm. approx. (19.3 x 12.99 x 12.20 inches approx.). Weight: 30 Kg. approx. (66 pounds approx.).

#### -QRC/PLC-SOF. PLC Control Software:

Always included with PLC supply.

Each Chemical Reactor has its own Software.

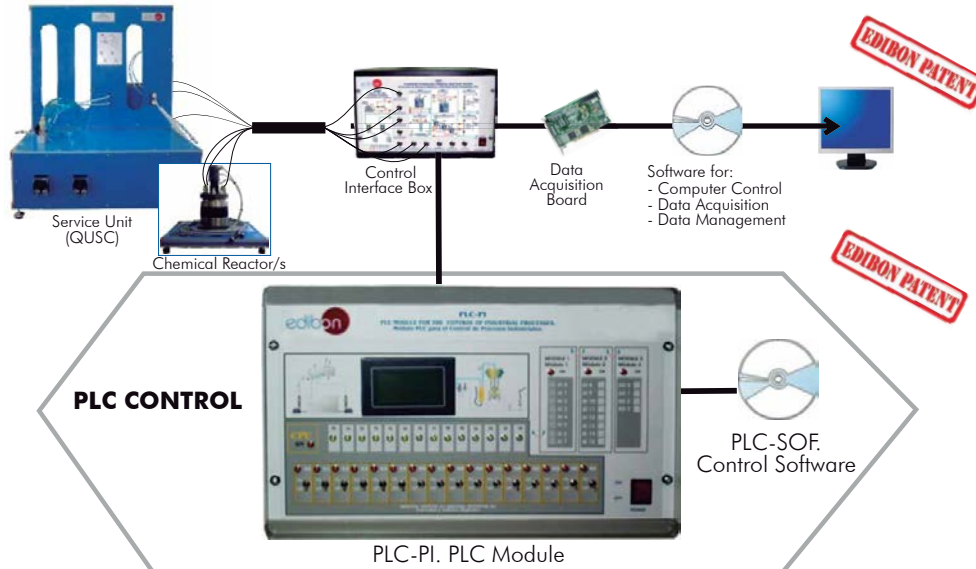

#### Practices to be done with PLC-PI:

- 1.- Control of the unit process through the control interface box without the computer.
- 2.- Visualization of all the sensors values used in the unit process.
- 3.- Calibration of all sensors included in the unit process.
- 4.- Hand on of all the actuators involved in the unit process.
- 5.- Realization of different experiments, in automatic way, without having in front the unit. (This experiment can be decided previously).
- 6.- Simulation of outside actions, in the cases hardware elements do not exist. (Example: test of complementary tanks, complementary industrial environment to the process to be studied, etc).
- 7.- PLC hardware general use and manipulation.
- 8.- PLC process application for unit.
- 9.- PLC structure.
- 10.- PLC inputs and outputs configuration.
- 11.- PLC configuration possibilities.
- 12.- PLC programming languages.
- 13.- PLC different programming standard languages.
- 14.- New configuration and development of new process.
- 15.- Hand on an established process.
- 16.- To visualize and see the results and to make comparisons with the unit process.
- 17.- Possibility of creating new process in relation with the unit.
- 18.- PLC Programming exercises.
- 19.- Own PLC applications in accordance with teacher and student requirements.

⑧ **QRC/CAI. Computer Aided Instruction Software System.**

This complete software package includes two Softwares: the INS/SOF. Classroom Management Software (Instructor Software) and the QRC/SOF. Computer Aided Instruction Software (Student Software).

This complete software package consists of an Instructor Software (INS/ SOF) totally integrated with the Student Software (QRC/SOF). Both are interconnected so that the teacher knows at any moment what is the theoretical and practical knowledge of the students.

- INS/SOF. Classroom Management Software (Instructor Software):

The Instructor can:

- Organize Students by Classes and Groups.
- Create easily new entries or delete them.
- Create data bases with student information.
- Analyze results and make statistical comparisons.
- Generate and print reports.
- Detect student's progress and difficulties.
- ...and many other facilities.

Instructor Software

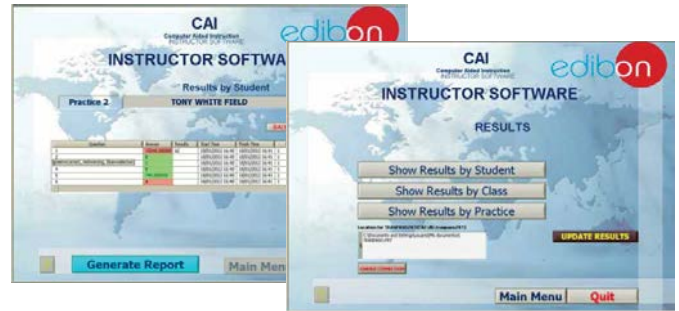

- QRC/SOF. Computer Aided Instruction Software (Student Software):

It explains how to use the unit, run the experiments and what to do at any moment.

This Software contains:

- Theory.
- Exercises.
- Guided Practices.
- Exams.

For more information see CAI catalogue. Click on the following link:

[www.edibon.com/products/catalogues/en/CAI.pdf](http://www.edibon.com/products/catalogues/en/CAI.pdf)

Student Software

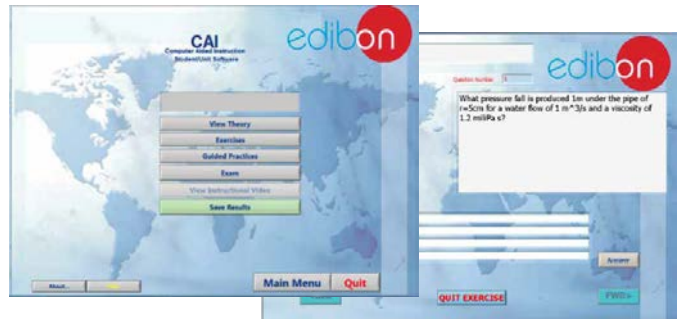

⑨ **QRC/FSS. Faults Simulation System.**

Faults Simulation System (FSS) is a Software package that simulates several faults in any EDIBON Computer Controlled Unit.

The "FAULTS" mode consists on causing several faults in the unit normal operation. The student must find them and solve them.

There are several kinds of faults that can be grouped in the following sections:

Faults affecting the sensors measurement:

- An incorrect calibration is applied to them.
- Non-linearity.

Faults affecting the actuators:

- Actuators channels interchange at any time during the program execution.
- Response reduction of an actuator.

Faults in the controls execution:

- Inversion of the performance in ON/OFF controls.
- Reduction or increase of the calculated total response.
- The action of some controls is annulled.

On/off faults:

- Several on/off faults can be included.

For more information see FSS catalogue. Click on the following link:

[www.edibon.com/products/catalogues/en/FSS.pdf](http://www.edibon.com/products/catalogues/en/FSS.pdf)

Example of some screens

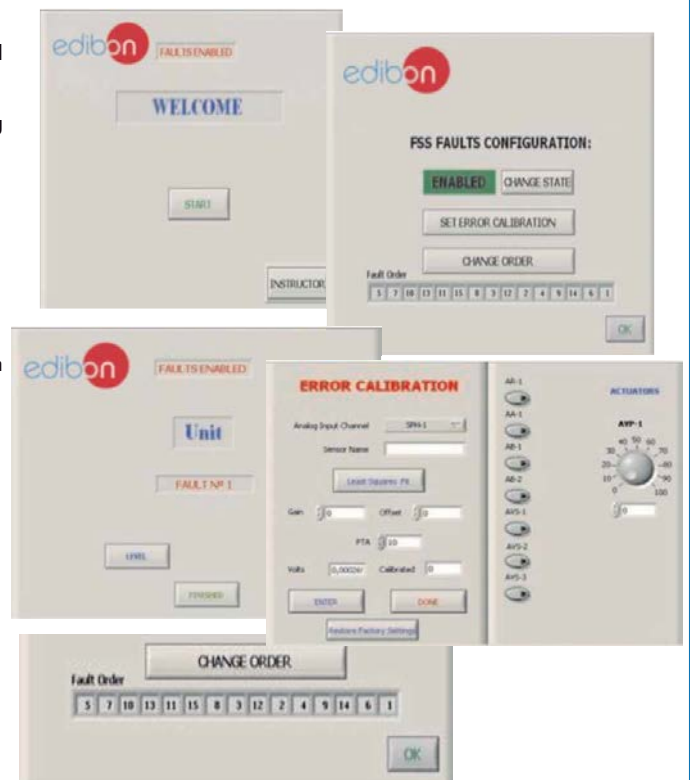

**10 QRC/CAL. Computer Aided Learning Software (Results Calculation and Analysis).**

This Computer Aided Learning Software (CAL) is a Windows based software, simple and very easy to use, specifically developed by EDIBON.

CAL is a class assistant that helps in doing the necessary calculations to extract the right conclusions from data obtained during the experimental practices.

CAL computes the value of all the variables involved and performs the calculations.

It allows to plot and print the results. Within the plotting options, any variable can be represented against any other.

Different plotting displays.

It has a wide range of information, such as constant values, unit conversion factors and integral and derivative tables.

For more information see CAL catalogue. Click on the following link:  
[www.edibon.com/products/catalogues/en/CAL.pdf](http://www.edibon.com/products/catalogues/en/CAL.pdf)

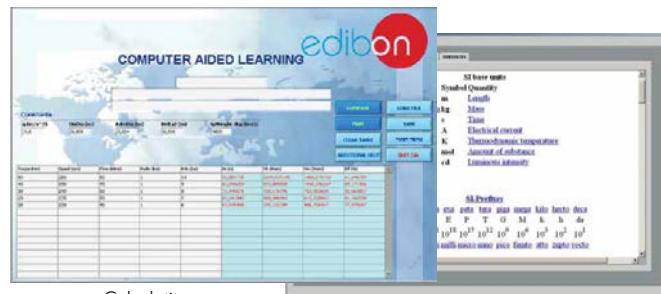

Calculations

Information of constant values, unit conversion factors and integral and derivative tables

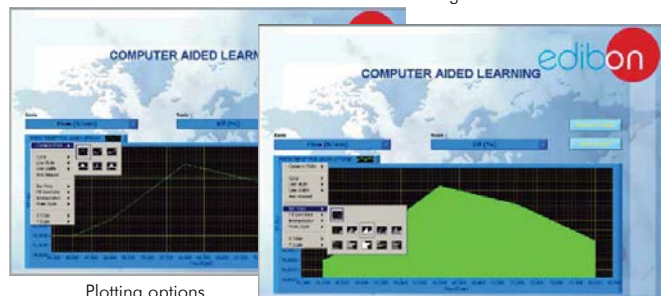

Plotting options

**11 Mini ESN. EDIBON Mini Scada-Net System.**

Mini ESN. EDIBON Mini Scada-Net System allows up to 30 students to work with a Teaching Unit in any laboratory, simultaneously.

The Mini ESN system consists on the adaptation of any EDIBON Computer Controlled Unit with SCADA and PID Control integrated in a local network.

This system allows to view/control the unit remotely, from any computer integrated in the local net (in the classroom), through the main computer connected to the unit. Then, the number of possible users who can work with the same unit is higher than in an usual way of working (usually only one).

Main characteristics:

- It allows up to 30 students to work simultaneously with the EDIBON Computer Controlled Unit with SCADA and PID Control, connected in a local net.
- Open Control + Multicontrol + Real Time Control + Multi Student Post.
- Instructor controls and explains to all students at the same time.
- Any user/student can work doing "real time" control/multicontrol and visualisation.
- Instructor can see in the computer what any user/student is doing in the unit.
- Continuous communication between the instructor and all the users/students connected.

Main advantages:

- It allows an easier and quicker understanding.
- This system allows you can save time and cost.
- Future expansions with more EDIBON Units.

For more information see Mini ESN catalogue. Click on the following link:  
[www.edibon.com/products/catalogues/en/Mini-ESN.pdf](http://www.edibon.com/products/catalogues/en/Mini-ESN.pdf)

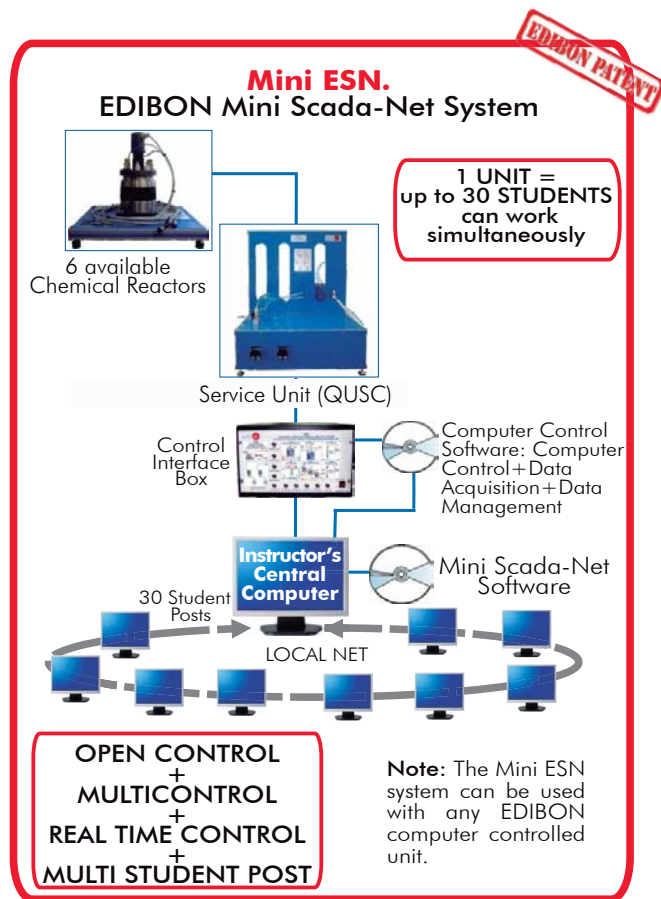

**12 ESN. EDIBON Scada-Net System.**

This unit can be integrated, in the future, into a Complete Laboratory with many Units and many Students.

For more information see ESN catalogue. Click on the following link:

[www.edibon.com/products/catalogues/en/units/chemicalengineering/esn-chemicalengineering/ESN-CHEMICAL\\_ENGINEERING.pdf](http://www.edibon.com/products/catalogues/en/units/chemicalengineering/esn-chemicalengineering/ESN-CHEMICAL_ENGINEERING.pdf)

**Items always supplied as minimum configuration**

Common items for the Chemical Reactors:

- ① QUSC. **Service Unit.** (Common for the Chemical Reactors and can work with one or several reactors).
- ② QRC/CIB. **Control Interface Box.** (Common for the Chemical Reactors and can work with one or several reactors).
- ③ DAB. **Data Acquisition Board.** (Common for the Chemical Reactors).

④ Chemical Reactors:

- ④ QRCAC. **Continuous Stirred Tank Reactor,** and/or
- ④ QRTC. **Tubular Flow Reactor,** and/or
- ④ QRDC. **Batch Reactor,** and/or
- ④ QRSC. **Stirred Tank Reactors in Series,** and/or
- ④ QRLC. **Laminar Flow Reactor,** and/or
- ④ QRPC. **Plug Flow Reactor.**

⑤ **Cables and Accessories,** for normal operation.

⑥ **Manuals.**

**Additional and optional items**

- ⑦ PLC. Industrial Control using PLC (it includes PLC-PI Module plus PLC-SOF Control Software):
  - PCL-PI. PLC Module.
  - QRC/PLC-SOF. PLC Control Software.
- ⑧ QRC/CAI. Computer Aided Instruction Software System.
- ⑨ QRC/FSS. Faults Simulation System.
- ⑩ QRC/CAL. Computer Aided Learning Software. (Results Calculation and Analysis).

Expansions

- ⑪ Mini ESN. Multipost EDIBON Mini Scada-Net System.
- ⑫ ESN. Multipost EDIBON Scada-Net System.

\*Specifications subject to change without previous notice, due to the convenience of improvements of the product.



C/ Del Agua, 14. Polígono Industrial San José de Valderas.  
28918 LEGANÉS. (Madrid). SPAIN.

Phone: 34-91-6199363 FAX: 34-91-6198647

E-mail: edibon@edibon.com WEB site: [www.edibon.com](http://www.edibon.com)

Issue: ED01/14  
Date: October/2014

REPRESENTATIVE: