

Key features:

- ▶ **Several Utilities and Final User options.**
- ▶ **Modular and scalable applications (from simple to advance complexity).**
- ▶ **Scalable and expandable applications.**
- ▶ **Possibility to work either with individual applications or combined applications to form simulators (Generation + Transmission/Distribution + Loads).**
- ▶ **Use of real devices as substations protection relays, generators management devices, frequency controllers, etc.**
- ▶ **EDIBON SCADA System (Supervision, Control and Data Acquisition) always included.**
- ▶ **Smart Grid devices.**
- ▶ **Micro-Grids.**

www.edibon.com

Products
Products range
Units
5.-Energy



ISO 9000: Quality Management
(for Design, Manufacturing,
Commercialization and After-sales service)



European Union Certificate
(total safety)



Certificates ISO 14000 and
ECO-Management and Audit Scheme
(environmental management)



Worlddidac Quality Charter
Certificate and
Worlddidac Member

AEL-MPSS

1. GENERATION SYSTEMS



AEL-GCA- Automatic Control Generation Systems options.
 AEL-GCM- Manual Control Generation Systems options.
 AEL-GAD- Additional Generation Systems options.

2. TRANSMISSION/DISTRIBUTION SYSTEMS



AEL-T- Transmission and Distribution Power Systems options.

3. LOADS SYSTEMS



AEL-C- Conventional Loads options.
 AEL-CS- Special Loads options.

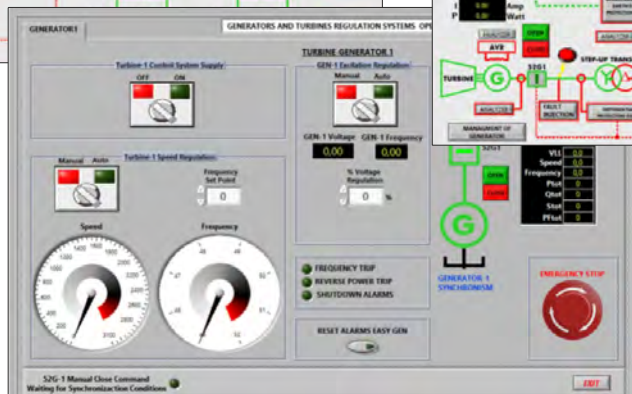
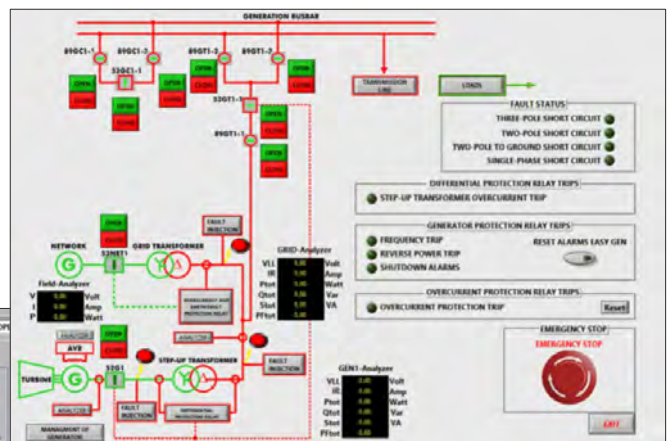
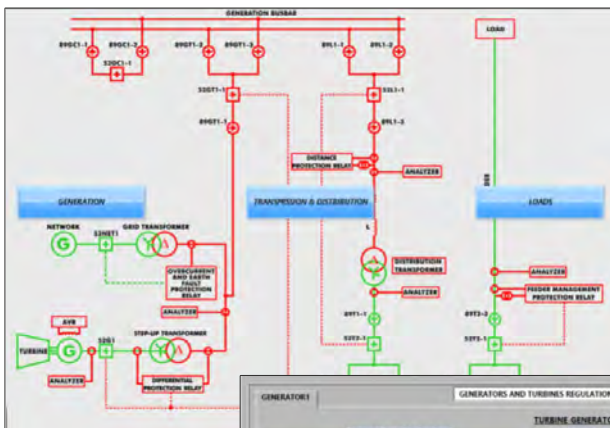
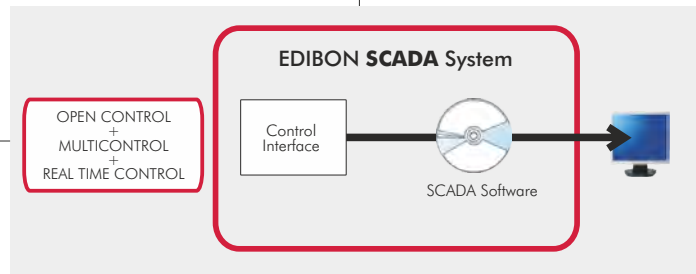

ALL AVAILABLE OPTIONS

1. GENERATION SYSTEMS		
AEL-GCA- Automatic Control Generation Systems options	AEL-GCM- Manual Control Generation Systems options	AEL-GAD- Additional Generation Systems options
<p style="text-align: center; margin: 0;"><u>Applications</u></p> <p>Synchronization Studies</p> <p>AEL-GCA-P-02S. Generation System with Automatic Control of Synchronous Generator, Synchronization and Protection Relays, with SCADA.</p> <p>AEL-GCA-02S. Generation System with Automatic Control of Synchronous Generator and Synchronization, with SCADA.</p> <p>AEL-GCA-P-03S. Automatic Synchronization System of Synchronous Generator with Servomotor and Protection Relays, with SCADA.</p> <p>AEL-GCA-03S. Automatic Synchronization System of Synchronous Generator with Servomotor, with SCADA.</p> <p>Isolated Grid Studies</p> <p>AEL-GCA-P-01S. Generation System with Automatic Control of Synchronous Generator in an Isolated Grid and Protection Relays, with SCADA.</p> <p>AEL-GCA-01S. Generation System with Automatic Control of Synchronous Generator in an Isolated Grid, with SCADA.</p>	<p style="text-align: center; margin: 0;"><u>Applications</u></p> <p>Synchronization Studies</p> <p>AEL-GCM-P-02S. Generation System with Manual Control of Synchronous Generator, Synchronization and Protection Relays, with SCADA.</p> <p>AEL-GCM-02S. Generation System with Manual Control of Synchronous Generator and Synchronization, with SCADA.</p> <p>AEL-GCM-P-03S. Manual Synchronization System of Synchronous Generator with Servomotor and Protection Relays, with SCADA.</p> <p>AEL-GCM-03S. Manual Synchronization System of Synchronous Generator with Servomotor, with SCADA.</p> <p>Isolated Grid Studies</p> <p>AEL-GCM-P-01S. Generation System with Manual Control of Synchronous Generator in an Isolated Grid and Protection Relays, with SCADA.</p> <p>AEL-GCM-01S. Generation System with Manual Control of Synchronous Generator in an Isolated Grid, with SCADA.</p>	<p style="text-align: center; margin: 0;"><u>Applications</u></p> <p>AEL-GAD-01S. Pumping Power Plant, with SCADA.</p> <p>AEL-GAD-02S. Auto-Start Diesel Generator Trainer for Recovery of the Energy System due to Black-Outs, with SCADA.</p> <p>AEL-GAD-03S. Automatic Generation System with Two Parallel Generators, with SCADA.</p> <p>AEL-GAD-04S. Hydroelectric Power Plant, with SCADA.</p> <p style="margin-top: 10px;">These applications can be complemented with AEL-GCA and AEL-GCM applications.</p>

2. TRANSMISSION/DISTRIBUTION SYSTEMS

AEL-T- Transmission and Distribution Power Systems options
<p style="text-align: center; margin: 0;"><u>Applications</u></p> <p>One Line and Regulation Transformer Studies</p> <p>AEL-T-P-01S. Transmission and Distribution Power Systems with Regulation Transformer and Protection Relays, with SCADA.</p> <p>AEL-T-01S. Transmission and Distribution Power Systems with Regulation Transformer, with SCADA.</p> <p>Two Aerial Lines Studies</p> <p>AEL-T-P-02S. Transmission and Distribution Power Systems with Two Aerial Parallel Lines and Protection Relays, with SCADA.</p> <p>AEL-T-02S. Transmission and Distribution Power Systems with Two Aerial Parallel Lines, with SCADA.</p> <p>Additional Studies Possibilities</p> <p>AEL-T-P-04S. Electrical Distribution Grids Trainer with Protections Relays, with SCADA.</p> <p>AEL-T-04S. Electrical Distribution Grids Trainer, with SCADA.</p> <p>AEL-T-03S. Power Flow Control in Meshed Networks, with SCADA.</p>

3. LOADS SYSTEMS (Energy Utilization)

AEL-C- Conventional Loads options	AEL-CS- Special Loads options
<p>AEL-C-P-02S. Loads Systems with Automatic Power Factor Compensation and Protection Relays, with SCADA.</p> <p>AEL-C-02S. Loads Systems with Automatic Power Factor Compensation, with SCADA.</p> <p>AEL-C-P-01S. Loads Systems with Manual Power Factor Compensation and Protection Relays, with SCADA.</p> <p>AEL-C-01S. Loads Systems with Manual Power Factor Compensation, with SCADA.</p>	<p>AEL-C-03S. Complex Loads, Power Consumption Measurement and Peak Load Monitoring, with SCADA.</p>

* Each application can work individually or combined with other applications to form systems simulators (Generation + Transmission/Distribution + Loads).

Due to the growth and development of electric power systems it has been required to design increasingly sophisticated devices to manage electric power in a safer and more efficient way.

Nowadays, protection and monitoring devices, which allow to know the electrical parameters in real time, such as voltage level in the nodes of the grid, current level in the lines, active and reactive power level, frequency values, etc., are essential in the electrical grids. Protection systems play an important role in power systems, since they can control in a practically independent way the safety and continuity of the power supply, as well as the quality of the energy the final consumer gets.

The Modular Smart Grid Power Systems Simulators (Utilities) "AEL-MPSS", with more than **285 control variables**, have been designed to make and use the same technology employed in power systems available in the industrial world, easy to use by experts and inexperienced people. We included the safety conditions required to perform different short-circuit tests and experiments.

The AEL-MPSS systems simulators are specially designed and aimed at technical professional training, vocational training, for higher education and even applied research, as well as the improvement in all fields through advanced systems.

The Modular Smart Grid Power Systems Simulators (Utilities) "AEL-MPSS" can be configured from three great areas formed by several options and applications as:

1. Generation systems applications.
2. Transmission/Distribution systems applications.
3. Loads systems applications.

The objective of each area is to study a field of the electric power systems. All the options available in these three great areas have been designed to be able to work either independently or combining with several options and applications in order to configure systems simulators (generation + transmission/ distribution + loads).

Due to the flexibility of our modular applications, it is possible to begin with easy applications for students with basic knowledge of power systems and/or to combine several applications for intermediate or advanced levels. Thus, a system simulator consisting of applications of generation, transmission/ distribution and loads will be created. Optionally, all of them including cutting edge protection relays to test their efficiency and reliability against any electrical fault.

All applications on this catalogue include the SCADA (Supervision, Control and Data Acquisition), which allows to study the operation of today's power systems in depth. This software enables the student to control the devices that make up the power systems remotely, observe in real time how the typical operations of an electrical substation work, which are the voltage and current values at different points of the transport networks, how much energy is generated and what occurs when the excitation current of our generator is increased or decreased.

Main features of Modular Smart Grid Power Systems Simulators (Utilities) "AEL-MPSS":

- Several Utilities and Final User options.
- Modular and scalable applications (from simple to advance complexity).
- Scalable and expandable applications.
- Possibility to work either with individual applications or combined applications to form simulators (Generation + Transmission/Distribution + Loads).
- Use of real devices as substations protection relays, generators management devices, frequency controllers, etc.
- EDIBON SCADA System (Supervision, Control and Data Acquisition) always included.
- Smart Grid devices.
- Micro-Grids.

The AEL-MPSS Modular Power Systems is one of the most advanced and complete modular power systems of the market. In the following pages the most important variables which allow the control of the system both in local and remote through the included SCADA are indicated.

The following are the most important **285 control variables** that make the AEL-MPSS a forefront system able to interact with the user thanks to the cutting-edge included devices.

The AEL-MPSS has been designed to show any electric phenomenon that are present in real power systems, such as short circuits, over currents, over voltages, over frequencies, reverse power, generator runaway, etc.

A variable is any element or symbol of our system susceptible to be modified directly or indirectly by the user and the control system.

All power systems are formed by three fundamental parts:

1. Generation System.
2. Transmission/Distribution System.
3. Load System.

1. Generation System:

Power generation is the point where all power systems born, where transmission lines emerge up to distribution lines and finally, to give electrical service to the final consumer. It is necessary a great quantity of control variables for a power system reliable, safe and optimal because of these variables depend the electrical energy quality. This is the reason why the generation systems of the AEL-MPSS includes the **145 control variables** most important that will allow user to interact with a sophisticated, real and intelligent generation system, which is able to respond automatically against energy demand, it is able to protect automatically against short circuits, with light indicators and alarms that will allow us to understand at all time the generation system state.

See the 145 control variables in next page.

2. Transmission/Distribution System:

After power generation, transmission and distribution systems are required to give power to the final consumer. These systems are highways of aluminum and steel which transport great quantities of power up to strategic points of the country and even other countries. In the transmission systems is very important to know variables such as transported energy, length transmission lines, capacitive effect, energy losses produced along kilometers and kilometers, etc. Besides, in a transmission line system is not enough a conventional protection system. For these systems are required distance protection relays able to detect changes in the line impedances and to sense undetectable anomalies for other conventional protection relays.

Distribution substations adapt the transmission lines voltage levels up to lower voltage levels for energy distribution. On this point take importance the distribution transformer with voltage regulator, which are able to compensate the transmission liens drop voltages.

The transmission/distribution power system of AEL-MPSS allows to study all these control variables and much more. In the following page the most important **76 control variables** that allow the user to interact with the transmission/distribution system are listed.

See the 76 control variables in next page.

3. Load System:

Once the energy is transported, this has to be carried to the consumption points through distribution lines. Final consumer provokes changes in the power balance of the system from generation up to distribution. On this way, all machinery of the system (generation, transmission and distribution) works in real time in order to the electrical parameters remain constants in the consumption points.

In the consumption points is very important to ensure the electrical energy quality through reactive energy compensation devices. Besides, on this point are essential the feeders management protection relays, which are installed in strategic points of the distribution lines giving to the grid the required reliability, safety and efficiency. These protection relays monitor electrical variables such as frequency, voltage, current, power factor, etc. in order to protect the grid.

In the following page the most important **64 control variables** which allow user to interact with the load system are listed.

See the 64 control variables in next page.

The most important 285 control variables which allow user to interact with the load system are listed below:

1. Generation System: the most important and used 145 physical variables in the industrial power systems.

1.1. Some general control variables of the Turbine-Generator group.

- Manual Control Variable for emergency stop of the Turbine-Generator group.
- Control Variable for starting order of the Turbine-Generator in automatic mode.
- Permission Variable for synchronization in automatic mode.

1.2. Local Control Mode of Turbine-Generator group.

1.2.1. Local Control of the group in manual mode.

- Island mode:

- Manual Control Variable for turbine frequency/speed control with analog potentiometer.
- Manual Control Variable for synchronous generator excitation with analog potentiometer.
- Manual Control Variable for 52G breaker open/close.

- "Load sharing/parallel grid" mode:

- Manual Control Variable for synchronization the generator and the grid.
- Manual Control Variable for Active Power given to the grid.
- Manual Control Variable for Reactive Power given to the grid.
- Manual Control Variable for 52G breaker open/close.

1.2.2. Local Control of the group in automatic mode.

- Island mode:

- Automatic Control Variable for turbine frequency/speed control through AVR (Automatic Voltage Regulator).
- Automatic Control Variable for synchronous generator excitation/voltage control through AVR (Automatic Voltage Regulator).
- Automatic Control Variable for line and phase voltages.
- Automatic Control Variable for Reactive Power given to the grid.
- Automatic Control Variable for maximum line current.
- Automatic Control Variable for 52G breaker open/close.

- "Load sharing/parallel grid" mode:

- Automatic Control Variable for synchronization the synchronous generator with the grid.
- Automatic Control Variable for Active Power given to the grid.
- Automatic Control Variable for Active Power maximum limit.
- Automatic Control Variable for Reactive Power given to the grid.
- Automatic Control Variable for Reactive Power maximum limit.
- Automatic Control Variable for adjusting the synchronous generator optimum power factor.
- Automatic Control Variable for 52G breaker open/close.
- Automatic Control Variable for line and phase voltages.
- Automatic Control Variable for maximum line current.

1.3. Remote Control (SCADA) of Turbine-Generator group

1.3.1. Manual Remote Control (SCADA) of Turbine-Generator group.

- Island Mode:

- Manual Control Variable for turbine frequency/speed control with analog potentiometer.
- Manual Control Variable for synchronous generator excitation with analog potentiometer.

- Manual Control Variable for 52G breaker open/close.

- Load Sharing/Parallel Grid Mode:

- Manual Control Variable for synchronization the generator and the grid.
- Manual Control Variable for Active Power given to the grid.
- Manual Control Variable for Reactive Power given to the grid.
- Manual Control Variable for 52G breaker open/close.

1.3.2. Automatic Remote Control (SCADA) of Turbine-Generator group.

- Island Mode:

- Automatic Control Variable for turbine frequency/speed control through AVR (Automatic Voltage Regulator).
- Automatic Control Variable for synchronous generator excitation/voltage control through AVR (Automatic Voltage Regulator).
- Automatic Control Variable for line and phase voltages.
- Automatic Control Variable for Reactive Power given to the grid.
- Automatic Control Variable for maximum line current.
- Automatic Control Variable for 52G breaker open/close.

- Load Sharing/Parallel Grid Mode:

- Automatic Control Variable for synchronization the synchronous generator with the grid.
- Automatic Control Variable for Active Power given to the grid.
- Automatic Control Variable for Active Power maximum limit.
- Automatic Control Variable for Reactive Power given to the grid.
- Automatic Control Variable for Reactive Power maximum limit.
- Automatic Control Variable for adjusting the synchronous generator optimum power factor.
- Automatic Control Variable for 52G breaker open/close.
- Automatic Control Variable for line and phase voltages.
- Automatic Control Variable for maximum line current.

1.4. Control Variables for protection system.

1.4.1. Over Current and Earth fault protection relay.

- Configuration variable for the current transformer relationship.
- Configuration variable for the voltage transformer relationship.
- Configuration variable for the removing fault time (TRIP duration).
- Configuration variable for Level 1 instantaneous overcurrent 50P1P.
- Configuration variable for Level 2 instantaneous overcurrent 50P2P.
- Configuration variable for Level 3 instantaneous overcurrent 50P3P.
- Configuration variable for Level 4 instantaneous overcurrent 50P4P.
- Configuration variable for Level 5 instantaneous overcurrent 50P5P.
- Configuration variable for Level 6 instantaneous overcurrent 50P6P.
- Configuration variable for the inverse time overcurrent parameter threshold.
- Configuration variable for inverse time curve type 51P1T: U1, U2, U3, U4, U5, C1, C2, C3, C4, C5.

1.4.1. Over Current and Earth fault protection relay. (continuation)

- Configuration variable for the 51P1T Time-Dial of the inverse time overcurrent protection curve parameter.
- Configuration variable for the 51P2T inverse time curve threshold.
- Configuration variable for inverse time curve type 51P2T: U1, U2, U3, U4, U5, C1, C2, C3, C4, C5.
- Configuration variable for the 51P2P Time-Dial of the inverse time overcurrent protection curve parameter.
- Configuration variable for 50N1 neutral instantaneous overcurrent threshold.
- Configuration variable for 50N2 neutral instantaneous overcurrent threshold.
- Configuration variable for 51N1T inverse time neutral overcurrent parameter threshold.
- Configuration variable for inverse time curve type 51N1T: U1, U2, U3, U4, U5, C1, C2, C3, C4, C5.
- Configuration variable for the 51N1T Time-Dial of the inverse time overcurrent protection curve parameter.
- Configuration variable for 50G1 instantaneous residual overcurrent parameter threshold.
- Configuration variable for 50G2 instantaneous residual overcurrent parameter threshold.
- Configuration variable for 50G1T inverse time residual overcurrent parameter threshold.
- Configuration variable for inverse time curve type 51G1T: U1, U2, U3, U4, U5, C1, C2, C3, C4, C5.
- Configuration variable for the 51G1T Time-Dial of the inverse time overcurrent protection curve parameter.
- Configuration variable for 51Q1P negative sequence instantaneous overcurrent parameter threshold.
- Configuration variable for 51Q2P negative sequence instantaneous overcurrent parameter threshold.
- Configuration variable for 51Q1T inverse time overcurrent parameter threshold.
- Configuration variable for inverse time curve type 51Q1T: U1, U2, U3, U4, U5, C1, C2, C3, C4, C5.
- Configuration variable for the 51Q1T Time-Dial of the inverse time overcurrent protection curve parameter.
- Configuration variable for 51Q2T inverse time overcurrent parameter threshold.
- Configuration variable for inverse time curve type 51Q2T: U1, U2, U3, U4, U5, C1, C2, C3, C4, C5.
- Configuration variable for the 51Q2T Time-Dial of the inverse time overcurrent protection curve parameter.

1.4.2. Differential Protection Relay of Step-Up power transformer

- Configuration variable for the current transformer relationship.
- Configuration variable for the voltage transformer relationship.
- Configuration variable for the removing fault time (TRIP duration).
- Configuration variable for power transformer connection type.
- Configuration variable for measurement transformer connection type.
- Configuration variable for 87P differential protection element.
- Configuration variable for SLP1 restriction percentage of 87P differential element.
- Configuration variable for SLP2 restriction percentage of 87P differential element.

- Configuration variable for 2° harmonic restriction percentage.
- Configuration variable for 4° harmonic restriction percentage.
- Configuration variable for 5° harmonic restriction percentage.
- Configuration variable for 50P1P instantaneous overcurrent level of the primary winding power transformer.
- Configuration variable for 51P1D define time instantaneous overcurrent level of the primary winding power transformer.
- Configuration variable for 51P1P inverse time overcurrent threshold of the power transformer primary winding.
- Configuration variable for inverse time curve type 51P1P: U1, U2, U3, U4, U5, C1, C2, C3, C4, C5.
- Configuration variable for the 51P1P Time-Dial of the inverse time overcurrent protection curve parameter.
- Configuration variable for 50Q1P negative sequence instantaneous overcurrent threshold of the power transformer primary winding.
- Configuration variable for 51Q1P negative sequence inverse time overcurrent threshold of the power transformer primary winding.
- Configuration variable for inverse time curve type 51Q1P: U1, U2, U3, U4, U5, C1, C2, C3, C4, C5.
- Configuration variable for 51Q1P Time-Dial of the inverse time overcurrent protection curve parameter.
- Configuration variable for 50N1P instantaneous residual overcurrent threshold of the power transformer primary winding.
- Configuration variable for 50N1P inverse time residual overcurrent threshold of the power transformer primary winding.
- Configuration variable for inverse time curve type 51N1P: U1, U2, U3, U4, U5, C1, C2, C3, C4, C5.
- Configuration variable for 51N1P Time-Dial of the inverse time overcurrent protection curve parameter.
- Configuration variable for 50P2P instantaneous overcurrent level of the power transformer secondary winding.
- Configuration variable for 50P2D define time instantaneous overcurrent level of the power transformer secondary winding.
- Configuration variable 51P2P inverse time overcurrent threshold of the power transformer secondary winding.
- Configuration variable for inverse time curve type 51P2P: U1, U2, U3, U4, U5, C1, C2, C3, C4, C5.
- Configuration variable for 51P2P Time-Dial of the inverse time overcurrent protection curve parameter.
- Configuration variable for 50Q2P negative sequence instantaneous overcurrent threshold of the power transformer secondary winding.
- Configuration variable for 51Q2P negative sequence inverse time overcurrent threshold of the power transformer secondary winding.
- Configuration variable for inverse time curve type 51Q2P: U1, U2, U3, U4, U5, C1, C2, C3, C4, C5.
- Configuration variable for 51Q2P Time-Dial of the inverse time overcurrent protection curve parameter.
- Configuration variable for 50N2P instantaneous residual overcurrent threshold of the power transformer secondary winding.
- Configuration variable for 50N2P inverse time residual overcurrent threshold of the power transformer primary winding.
- Configuration variable for inverse time curve type 51N2P: U1, U2, U3, U4, U5, C1, C2, C3, C4, C5.
- Configuration variable for 51N2P Time-Dial of the inverse time overcurrent protection curve parameter.

1.4.3. Protection Relay of Turbine-Generator Group.

- Configuration variable of synchronous generator nominal power.
- Configuration variable of synchronous generator poles number.
- Configuration variable of instantaneous overcurrent protection threshold.
- Configuration variable of inverse time overcurrent protection threshold.
- Configuration variable of overvoltage protection threshold.
- Configuration variable of undervoltage protection threshold.
- Configuration variable of overfrequency protection threshold.
- Configuration variable of subfrequency protection threshold.
- Configuration variable of reverse power level.
- Configuration variable of Proportional, Integral and Derivative (PID) for Turbine-Generator group control and regulation.

1.5. Control variables of double bus bar generation substation switchgear. Local and remote control possibility (SCADA).

- Control variable of open/close 89GC1-1 coupling disconnecter.
- Control variable of open/close 89GC1-2 coupling disconnecter.
- Control variable of open/close 52GC1-1 coupling breaker.
- Control variable of open/close 89GT1-1 transformer disconnecter.
- Control variable of open/close 89GT1-2 transformer disconnecter.
- Control variable of open/close 89GT1-3 transformer disconnecter.
- Control variable of open/close 52GT1-1 transformer breaker.
- Control variable of open/close 52NET grid breaker.
- Control variable of open/close 52G1 generation breaker.

1.6. Control variables for faults selection.

1.6.1. Local/Remote control (SCADA):

- Control variable for direct single phase short preselection.
- Control variable for single phase short circuit with fault impedance.
- Control variable for direct two phases to ground short circuit preselection.
- Control variable for two phases to ground short circuit preselection with fault impedance.
- Control variable for direct two phase short circuit preselection.
- Control variable for two phase short circuit preselection with fault impedance.
- Control variable for direct three-phase phase short circuit preselection.
- Control variable for three-phase phase short circuit preselection with fault impedance.
- Control variable for fault injection.

2. Transmission/Distribution System: the most important and used 76 physical variables in the industrial power systems.

- 2.1. Control variables of double bus bar emitter substation switchgear. Possibility to control both local and remote modes (SCADA).
 - Control variable of open/close 89T1-1 disconnecter.
 - Control variable of open/close 89T1-2 disconnecter.
 - Control variable of open/close 89T1-3 disconnecter.
 - Control variable of open/close 52T1-1 breaker.
- 2.2. Control variables of double bus bar receptor substation switchgear. Possibility to control both local and remote modes (SCADA).
 - Control variable of open/close 89L1-1 disconnecter.
 - Control variable of open/close 89L1-2 disconnecter.
 - Control variable of open/close 89L1-3 disconnecter.
 - Control variable of open/close 52T2-1 breaker.
- 2.3. Control variables of distribution transformer voltage regulator. Possibility to control both local and remote modes (SCADA).
 - Control variable for voltage regulation at 0 %.
 - Control variable for voltage regulation at 2, 5 %.
 - Control variable for voltage regulation at 5 %.
 - Control variable for voltage regulation at 7, 5 %.
 - Control variable for voltage regulation at -2, 5 %.
 - Control variable for voltage regulation at -5 %.
 - Control variable for voltage regulation at -7,5 %.
- 2.4. Control variables of transmission line parameters. Local and remote control possibility (SCADA).
 - Variable control for line resistor.
 - Variable control for line inductance.
 - Variable control for line capacitance.
 - Variable control for breaking line 1.
 - Variable control for breaking line 1 and line 2.
 - Variable control for breaking line 1, line 2 and line 3.
- 2.5. Control variables of distance protection relay.
 - Configuration variable for current transformer relationship.
 - Configuration variable for voltage transformer relationship.
 - Configuration variable for remove fault duration.
 - Configuration variable for line impedance.
 - Configuration variable for length line.
 - Configuration variables for Mho distance elements.
 - Configuration variable for Z1P instantaneous distance element of zone 1.
 - Configuration variable for Z2P instantaneous distance element of zone 2.
 - Configuration variable for Z3P instantaneous distance element of zone 3.
 - Configuration variable for Z4P instantaneous distance element of zone 4.
 - Configuration variable for 50PP1 instantaneous overcurrent element of zone 1.
 - Configuration variable for 50PP2 instantaneous overcurrent element of zone 2.
 - Configuration variable for 50PP3 instantaneous overcurrent element of zone 3.
 - Configuration variable for 50PP4 instantaneous overcurrent element of zone 4.
 - Configuration variable for Z1MG ground impedance element of zone 1.
 - Configuration variable for Z2MG ground impedance element of zone 2.
 - Configuration variable for Z3MG ground impedance element of zone 3.
 - Configuration variable for Z4MG ground impedance element of zone 4.
 - Configuration variable for Z1D time distance element of zone 1.
 - Configuration variable for Z2D time distance element of zone 2.
 - Configuration variable for Z3D time distance element of zone 3.
 - Configuration variable for Z4D time distance element of zone 4.
 - Configuration variable for 50P1P instantaneous overcurrent element of level 1.
 - Configuration variable for 50P2P instantaneous overcurrent element of level 2.
 - Configuration variable for 50P3P instantaneous overcurrent element of level 3.
 - Configuration variable for 50P4P instantaneous overcurrent element of level 4.
 - Configuration variable for 67P1D define time overcurrent element of level 1.
 - Configuration variable for 67P2D define time overcurrent element of level 2.
 - Configuration variable for 67P3D define time overcurrent element of level 3.
 - Configuration variable for 67P4D define time overcurrent element of level 4.
 - Configuration variable for 50G1P residual instantaneous overcurrent element of level 1.
 - Configuration variable for 50G2P residual instantaneous overcurrent element of level 2.
 - Configuration variable for 50G3P residual instantaneous overcurrent element of level 3.
 - Configuration variable for 50G4P residual instantaneous overcurrent element of level 4.
 - Configuration variable for 67G1P residual define time overcurrent element of level 1.
 - Configuration variable for 67G2P residual define time overcurrent element of level 2.
 - Configuration variable for 67G3P residual define time overcurrent element of level 3.
 - Configuration variable for 67G4P residual define time overcurrent element of level 4.
 - Configuration variable for 50Q1P negative sequence instantaneous overcurrent element of level 1.
 - Configuration variable for 50Q2P negative sequence instantaneous overcurrent element of level 2.
 - Configuration variable for 50Q3P negative sequence instantaneous overcurrent element of level 3.
 - Configuration variable for 50Q4P negative sequence instantaneous overcurrent element of level 4.
 - Configuration variable for 67Q1D negative sequence define time overcurrent element of level 1.
 - Configuration variable for 67Q2D negative sequence define time overcurrent element of level 2.
 - Configuration variable for 67Q3D negative sequence define time overcurrent element of level 3.
 - Configuration variable for 67Q4D negative sequence define time overcurrent element of level 4.

2.5. Control variables of distance protection relay. (continuation)

- Configuration variable for 51PP inverse time overcurrent element of level 1.
- Configuration variable for 51PP inverse time overcurrent element type: U1-U5, C1-C5.
- Configuration variable for 51PP "Time Dial".
- Configuration variable for 51GP inverse time residual overcurrent element.
- Configuration variable for 51GP inverse time overcurrent element type: U1-U5, C1-C5.
- Configuration variable for 51GP "Time Dial".
- Configuration variable for 51QP inverse time negative sequence overcurrent element.
- Configuration variable for 51QP inverse time overcurrent element type: U1-U5, C1-C5.
- Configuration variable for 51QP "Time Dial".
- Configuration variable for directional element.

3. Load System: the most important and used 64 physical variables in the industrial power systems.

3.1. Control variables of double bus bar emitter distribution substation switchgear. Local and remote control possibility (SCADA).

- Control variable of open/close 89T2-1 disconnecter.
- Control variable of open/close 89T2-2 disconnecter.
- Control variable of open/close 89T2-3 disconnecter.
- Control variable of open/close 52T2-1 breaker.
- Control variable of open/close 89T1-1 disconnecter.
- Control variable of open/close 89T1-2 disconnecter.
- Control variable of open/close 89T1-3 disconnecter.
- Control variable of open/close 52T1-1 breaker.

3.2. Control variables for the connected type load. Possibility to control both local and remote modes (SCADA).

- Control variable for minimum resistive load.
- Control variable for medium resistive load.
- Control variable for maximum resistive load.
- Control variable for minimum inductive load.
- Control variable for medium inductive load.
- Control variable for maximum inductive load.
- Control variable for minimum capacitive load.
- Control variable for medium capacitive load.
- Control variable for maximum capacitive load.

3.3. Control variables for load power factor compensation. Possibility to control both local and remote modes (SCADA).

The load system has an automatic power factor controller able to remain constant the load power factor according to the set point previously adjusted by the user. Six capacitor steps give more or less reactive power in function of the connected load.

3.4. Control variables of feeder management protection relay

- Configuration variable for current transformer relationship.
- Configuration variable for voltage transformer relationship.
- Configuration variable for remove fault duration.
- Configuration variable for 50P1P instantaneous overcurrent of element 1.
- Configuration variable for 50P1D define time overcurrent of element 1.
- Configuration variable for 50P2P instantaneous overcurrent of element 2.
- Configuration variable for 50P2D define time overcurrent of element 2.
- Configuration variable for 50P3P instantaneous overcurrent of element 3.
- Configuration variable for 50P3D define time overcurrent of element 3.
- Configuration variable for 50P4P instantaneous overcurrent of element 4.
- Configuration variable for 50P4D define time overcurrent of element 4.
- Configuration variable for 50N1P instantaneous to neutral overcurrent of element 1.
- Configuration variable for 50N1D define time neutral overcurrent of element 1.

- Configuration variable for 50N2P instantaneous to neutral overcurrent of element 2.
- Configuration variable for 50N2D define time neutral overcurrent of element 2.
- Configuration variable for 50N3P instantaneous to neutral overcurrent of element 3.
- Configuration variable for 50N3D define time neutral overcurrent of element 3.
- Configuration variable for 50N4P instantaneous to neutral overcurrent of element 4.
- Configuration variable for 50N4D define time neutral overcurrent of element 4.
- Configuration variable for 50G1P instantaneous residual overcurrent of level 1.
- Configuration variable for 50G1D define time residual overcurrent of element 1.
- Configuration variable for 50G2P instantaneous residual overcurrent of level 2.
- Configuration variable for 50G2D define time residual overcurrent of element 2.
- Configuration variable for 50G3P instantaneous residual overcurrent of level 3.
- Configuration variable for 50G3D define time residual overcurrent of element 3.
- Configuration variable for 50G4P instantaneous residual overcurrent of level 4.
- Configuration variable for 50G4D define time residual overcurrent of element 4.
- Configuration variable for 50Q1P instantaneous negative sequence of element 1.
- Configuration variable for 50Q1D define time negative sequence overcurrent of element 1.
- Configuration variable for 50Q2P instantaneous negative sequence of element 2.
- Configuration variable for 50Q2D define time negative sequence overcurrent of element 2.
- Configuration variable for 50Q3P instantaneous negative sequence of element 3.
- Configuration variable for 50Q3D define time negative sequence overcurrent of element 3.
- Configuration variable for 50Q4P instantaneous negative sequence of element 4.
- Configuration variable for 50Q4D define time negative sequence overcurrent of element 4.
- Configuration variable for 55 power factor element.
- Configuration variable for 3PW power element.
- Configuration variable for 87D1TP frequency element 1.
- Configuration variable for 87D2TP frequency element 2.
- Configuration variable for 87D3TP frequency element 3.
- Configuration variable for 87D4TP frequency element 4.
- Configuration variable for 87D5TP frequency element 5.
- Configuration variable for 87D6TP frequency element 6.
- Configuration variable for 27P1P sub-voltage element 1.
- Configuration variable for 27P2P sub-voltage element 2.
- Configuration variable for 59P1P over-voltage element 1.
- Configuration variable for 59P2P over-voltage element 2.

1. GENERATION SYSTEMS



The generation systems area has been designed to transfer to the student all the knowledge required for the operation of today's electrical generation possibilities.

Main features of the Generation Systems:

- Modular and configurable applications.
- Possibility to work either with individual applications or combined applications to form systems simulators (Generation + Transmission/Distribution + Loads).
- All applications include SCADA (Supervision, Control and Data Acquisition), Electrical Workbench and PC.

Main Generation Systems options:

- AEL-GCA- Automatic Control Generation Systems options.
- AEL-GCM- Manual Control Generation Systems options.
- AEL-GAD- Additional Generation Systems options.

AEL-GCA- Automatic Control Generation Systems options:

We offer modular applications focused on the advanced study of electrical generators. The objective is to familiarize the student with the control devices employed in generation systems nowadays. These generation applications are more complex due to the control included in every module. It is possible to perform either a direct local control on each module or to control the entire application with SCADA.

It is possible to visualize from the software the electrical diagrams of a generation electrical substation, the transmission lines and the loads and to perform a direct control of the isolating switches and circuit breakers with each application. Besides, it is possible to inject different types of faults remotely and to analyze the behaviour of the protection relays located at strategic points of the system. Other possible operation is to perform alternately a manual control or an automatic control of the turbine-generator group.

There are different topics included, depending on the application:

- Study of generation substations with manual and automatic control of synchronous generator, synchronization and protections.
- Study of generation substations with manual and automatic control of synchronous generator and synchronization.
- Study of generation substations and synchronization with servomotor as prime mover.
- Study of generation substations with manual and automatic control of synchronous generator in isolated grids with protections.
- Study of generation substations with manual and automatic control of synchronous generator in isolated grids.

All applications include SCADA (Supervision, Control and Data Acquisition).

AEL-GCA-

Automatic Control Generation Systems options

Applications

Synchronization Studies

- AEL-GCA-P-02S. **Generation System with Automatic Control of Synchronous Generator, Synchronization and Protection Relays, with SCADA.**
- AEL-GCA-02S. **Generation System with Automatic Control of Synchronous Generator and Synchronization, with SCADA.**
- AEL-GCA-P-03S. **Automatic Synchronization System of Synchronous Generator with Servomotor and Protection Relays, with SCADA.**
- AEL-GCA-03S. **Automatic Synchronization System of Synchronous Generator with Servomotor, with SCADA.**

Isolated Grid Studies

- AEL-GCA-P-01S. **Generation System with Automatic Control of Synchronous Generator in an Isolated Grid and Protection Relays, with SCADA.**
- AEL-GCA-01S. **Generation System with Automatic Control of Synchronous Generator in an Isolated Grid, with SCADA.**

Applications**AEL-GCA-P-02S. Generation System with Automatic Control of Synchronous Generator, Synchronization and Protection Relays, with SCADA**

The AEL-GCA-P-02S is a modular application designed to study the generation systems with manual/automatic control of synchronous generator, protection relays and the necessary operations for synchronization with the mains.

This application includes a SCADA System for remote control operations.

This application represents an actual generation substation with double bus bar configuration, one synchronous generator and the electrical network in order to make the synchronization operations, opening and closing maneuvers with disconnectors and circuit breakers of the generation substation, etc.

This application includes a series of protection relays to study different electrical faults.

This application includes:

Modules:

- N-ALI01. Industrial Main Power Supply.
- N-BUS01. Generation Busbar.
- N-BUS02. Coupling Busbar.
- N-BUS03. Grid Busbar.
- N-EALD. Network Analyzer Unit with Computer Data Acquisition. (2 units)
- N-EALDC/G. DC Generator Analyzer.
- N-AVR/P. Automatic Voltage Regulator.
- N-WCA5K. 5KW Motor Speed Controller.
- N-ASY3PH. Three-Phase Automatic Synchronoscope.
- N-PLC01. PLC01 Control Module.
- N-ERP-SFT01. Overcurrent Protection Relay Module.
- N-ERP-PDF01. Differential Protection Relay Module.
- N-ERP-PGC01. Generator Protection and Control Relay Module.
- N-ERP-MF01. Digital Fault Simulator Module.
- N-TRANS3/5KSU. 5KW Three-Phase Step-Up Transformer Module.

Transformers:

- TRANS3/5KGR. 5KW Three-Phase Grid Transformer.
- TRANS3/5KSU. 5KW Three-Phase Step-Up Transformer.

Generators:

- GMG4.5K3PH. 4.5KW Generator-Motor Group.

SCADA (Supervision, Control and Data Acquisition).

This application can be combined with other applications of transmission/distribution systems and loads systems areas. Some examples of recommended configurations are shown at the end of this catalogue.

Some practical possibilities:

With local control mode:

- 1.- Studying of generation power systems with double busbar configuration.
 - 2.- Studying of opening and closing maneuvers of isolator switches and circuit breaker in double busbar systems.
 - 3.- Analysis of the measurements of the power flows of the synchronous generator.
 - 4.- Analysis of the active and reactive power of the generator.
 - 5.- Manual synchronization maneuvers of synchronous generator with the mains.
 - 6.- Automatic synchronization maneuvers of synchronous generator with the mains.
 - 7.- Studying of the synchronous generator in island operation mode.
 - 8.- Studying of the Micro-Grids.
 - 9.- Studying of the synchronous generator in grid parallel operation mode.
 - 10.- Studying of excitation/voltage regulation of synchronous generator in island mode.
 - 11.- Studying of turbine regulation (frequency control) in island mode.
 - 12.- Studying of excitation/voltage regulation of synchronous generator in parallel grid operation mode.
 - 13.- Studying of turbine regulation (frequency control) in parallel grid operation mode.
 - 14.- Studying of the power factor regulation of synchronous generator in parallel grid operation mode.
 - 15.- Studying of short circuits in different points of generation power system:
 - a. Symmetric short circuits: three-phase short circuits with and without contact impedance.
 - b. Asymmetric faults:
 - i. Two-phase short circuit with and without contact impedance.
 - ii. Two-phase to ground shortcircuit with and without contact impedance.
 - iii. Single-phase short circuit with and without contact impedance.
 - 16.- Studying of synchronous generator protection and control relay.
 - 17.- Studying of differential protection relay.
 - 18.- Studying of overcurrent protection relay.
- Remote control mode (with SCADA):
- 19.- Remotely control of generation power systems with double busbar.
 - 20.- Remotely control of opening and closing maneuvers of isolator switches and circuit breaker in double busbar systems.
 - 21.- Analysis with the SCADA software of synchronous generator power flows.
 - 22.- Analysis with SCADA software of active and reactive power of synchronous generator.
 - 23.- Remotely control of manual synchronization of synchronous generator with the mains.
 - 24.- Remotely control of automatic synchronization of synchronous generator with the mains.
 - 25.- Remotely control of synchronous generator in island grid operation mode.
 - 26.- Studying of Micro-Grids.
 - 27.- Remotely control of synchronous generator in parallel grid operation mode.
 - 28.- Remotely control of excitation/voltage regulation of synchronous generator in island mode.

Continue...

Applications**AEL-GCA-P-02S. Generation System with Automatic Control of Synchronous Generator, Synchronization and Protection Relays, with SCADA (continuation)**

Some practical possibilities (continuation):

- 29.- Remotely control of the turbine regulation (frequency control) in island operation mode.
- 30.- Remotely control of excitation/ voltage regulation of the synchronous generator in parallel grid operation mode.
- 32.- Remotely control of turbine regulation (frequency control) in parallel grid operation mode.
- 33.- Remotely control of power factor regulation of synchronous generator in parallel grid operation mode.
- 34.- Remotely control of short circuits in different points of the generation power system:
 - a. Symmetric short circuits: three-phase short circuits with and without contact impedance.
 - b. Asymmetric faults:
 - i. Two-phase short circuit with and without contact impedance.
 - ii. Two-phase to ground shortcircuit with and without contact impedance.
 - iii. Single-phase short circuit with and without contact impedance.
- 35.- Supervision of TRIPS from the SCADA software (protection relays shooting) in the power system.
- 36.- Remotely control of the synchronous generator protection and control relay.
- 37.- Remotely control of the differential protection relay.
- 38.- Remotely control of the overcurrent protection relay.
- 39.- Supervision of the electrical parameters of the generation system with the SCADA software.

AEL-GCA-02S. Generation System with Automatic Control of Synchronous Generator and Synchronization, with SCADA

The AEL-GCA-02S is a modular application designed to study the generation systems with manual/automatic control of synchronous generator and the necessary operations for synchronization with the mains.

This application includes a SCADA System for remote control operations.

This application represents an actual generation substation with double bus bar configuration, one synchronous generator and the electrical network in order to make the synchronization operations, opening and closing maneuvers with disconnectors and circuit breakers of the generation substation, etc.

This application includes:

Modules:

- N-ALI01. Industrial Main Power Supply.
- N-BUS01. Generation Busbar.
- N-BUS02. Coupling Busbar.
- N-BUS03. Grid Busbar.
- N-AVR/P. Automatic Voltage Regulator.
- N-EALD. Network Analyzer Unit with Computer Data Acquisition. (2 units)
- N-EALDC/G. DC Generator Analyzer.
- N-ASY3PH. Three-Phase Automatic Synchronoscope.
- N-WCA5K. 5KW Motor Speed Controller.
- N-PLC01. PLC01 Control Module.
- N-ERP-PGC01. Generation Protection and Control Relay Module.
- N-TRANS3/5KSU. 5KW Three-Phase Step-Up Transformer Module.

Transformers:

- TRANS3/5KGR. 5KW Three-Phase Grid Transformer.
- TRANS3/5KSU. 5KW Three-Phase Step-Up Transformer.

Generators:

- GMG4.5K3PH. 4.5KW Generator-Motor Group.

SCADA (Supervision, Control and Data Acquisition).

This application can be combined with other applications of transmission/distribution systems and loads systems areas. Some examples of recommended configurations are shown at the end of this catalogue.

Some practical possibilities:

- 1.- Manual/automatic frequency control of the synchronous generator.
- 2.- Manual/automatic current excitation control of the synchronous generator.
- 3.- Manual/automatic generation output control of the synchronous generator.
- 4.- Manual/automatic power factor control of the synchronous generator.
- 5.- Manual/automatic power flows control of the synchronous generator.
- 6.- Logic operations of disconnectors and circuit breakers of a generation substation.
- 7.- Manual/automatic operation for synchronization of the synchronous generator with the mains.
- 8.- Synchronoscope use for measuring mismatch voltages, frequencies and voltage modules.

Applications**AEL-GCA-P-03S. Automatic Synchronization System of Synchronous Generator with Servomotor and Protection Relays, with SCADA**

The AEL-GCA-P-03S is a modular application designed to study the generation systems with manual/automatic control of synchronous generator and the necessary operations for synchronization with the mains.

Besides, this application includes a series of protection relays in order to make different short circuit tests.

The speed of generator-motor group is controlled through servomotor.

This application includes a SCADA System for remote control operations.

This application represents an actual generation substation with double bus bar configuration, one synchronous generator moved by means of servomotor and the electrical network in order to make the synchronization operations.

This application can be combined with other applications of transmission/distribution systems and loads systems areas. Some examples of recommended configurations are shown at the end of this catalogue.

Some practical possibilities:

- 1.- Manual/automatic frequency control of the synchronous generator.
- 2.- Manual/automatic current excitation control of the synchronous generator.
- 3.- Manual/automatic generation output control of the synchronous generator.
- 4.- Manual/automatic power factor control of the synchronous generator.
- 5.- Manual/automatic power flows control of the synchronous generator.
- 6.- Logic operations of disconnectors and circuit breakers of a generation substation.
- 7.- Manual/automatic operation for synchronization of the synchronous generator with the mains.
- 8.- Synchronoscope use for measuring mismatch voltages, frequencies and voltage modules.
- 9.- Studying of the following protection relays: differential protection relay of the step-up transformer and the generator protection relay.
- 10.- Studying of the following short circuits types:
 - Three-Phase short circuit.
 - Two-Phase short circuit.
 - Two-Phase to ground short circuit.
 - Single-Phase short circuit.
- 11.- Adjusting of protection relay depending of the situation.
- 12.- Analyzing of the electrical faults transients with a special software.

AEL-GCA-03S. Automatic Synchronization System of Synchronous Generator with Servomotor, with SCADA

The AEL-GCA-03S is a modular application designed to study the generation systems with manual/automatic control of synchronous generator and the necessary operations for synchronization with the mains.

The speed of generator-motor group is controlled through servomotor.

This application includes a SCADA System for remote control operations.

This application represents an actual generation substation with double bus bar configuration, one synchronous generator moved by means of servomotor and the electrical network in order to make the synchronization operations.

This application can be combined with other applications of transmission/distribution systems and loads systems areas. Some examples of recommended configurations are shown at the end of this catalogue.

Some practical possibilities:

- 1.- Manual/automatic frequency control of the synchronous generator.
- 2.- Manual/automatic current excitation control of the synchronous generator.
- 3.- Manual/automatic generation output control of the synchronous generator.
- 4.- Manual/automatic power factor control of the synchronous generator.
- 5.- Manual/automatic power flows control of the synchronous generator.
- 6.- Logic operations of disconnectors and circuit breakers of a generation substation.
- 7.- Manual/automatic operation for synchronization of the synchronous generator with the mains.
- 8.- Synchronoscope use for measuring mismatch voltages, frequencies and voltage modules.

Applications**AEL-GCA-P-01S. Generation System with Automatic Control of Synchronous Generator in an Isolated Grid and Protection Relays, with SCADA**

The AEL-GCA-P-01S is a modular application designed to study the generation systems with manual/automatic control of synchronous generator in an isolated grid and protection relays, with SCADA.

This application represents an actual generation substation with double bus bar configuration, one synchronous generator and different protection relays to study electrical faults.

This application includes:

Modules:

- N-ALI01. Industrial Main Power Supply.
- N-BUS01. Generation Busbar.
- N-BUS02. Coupling Busbar.
- N-AVR/P. Automatic Voltage Regulator.
- N-EALD. Network Analyzer Unit with Computer Data Acquisition.
- N-EALDC/G. DC Generator Analyzer.
- N-WCA5K. 5KW Motor Speed Controller.
- N-PLC01. PLC01 Control Module.
- N-ERP-MF01. Digital Fault Simulator Module.
- N-ERP-PGC01. Generation Protection and Control Relay Module.
- N-ERP-PDF01. Differential Protection Relay Module.
- N-TRANS3/5KSU. 5KW Three-Phase Step-Up Transformer Module.

Transformers:

- TRANS3/5KSU. 5KW Three-Phase Step-Up Transformer.

Generators:

- GMG4.5K3PH. 4.5KW Generator-Motor Group.

SCADA (Supervision, Control and Data Acquisition).

This application can be combined with other applications of transmission/distribution systems and loads systems areas. Some examples of recommended configurations are shown at the end of this catalogue.

Some practical possibilities:

- 1.- Manual/automatic frequency control of the synchronous generator.
- 2.- Manual/automatic current excitation control of the synchronous generator.
- 3.- Manual/automatic generation output control of the synchronous generator.
- 4.- Manual/automatic power factor control of the synchronous generator.
- 5.- Manual/automatic power flows control of the synchronous generator.
- 6.- Logic operations of disconnectors and circuit breakers of a generation substation.
- 7.- Studying of the following protection relay, differential protection relay of the step-up transformer and the generator protection relay.
- 8.- Studying of the following short circuits types:
 - Three-Phase short circuit.
 - Two-Phase short circuit.
 - Two-Phase to ground short circuit.
 - Single-Phase short circuit.
- 9.- Adjusting of protection relay depending of the situation.
- 10.- Analyzing of the electrical faults transients with a special software.

AEL-GCA-01S. Generation System with Automatic Control of Synchronous Generator in an Isolated Grid, with SCADA

The AEL-GCA-01S is a modular application designed to study the generation systems with manual/automatic control of synchronous generator in an isolated grid with SCADA.

This application represents an actual generation substation with double bus bar configuration and one synchronous generator.

This application includes:

Modules:

- N-ALI01. Industrial Main Power Supply.
- N-BUS01. Generation Busbar.
- N-BUS02. Coupling Busbar.
- N-AVR/P. Automatic Voltage Regulator.
- N-EALD. Network Analyzer Unit with Computer Data Acquisition.
- N-EALDC/G. DC Generator Analyzer.
- N-WCA5K. 5KW Motor Speed Controller.
- N-PLC01. PLC01 Control Module.
- N-ERP-PGC01. Generation Protection and Control Relay Module.
- N-TRANS3/5KSU. 5KW Three-Phase Step-Up Transformer Module.

Transformers:

- TRANS3/5KSU. 5KW Three-Phase Step-Up Transformer.

Generators:

- GMG4.5K3PH. 4.5KW Generator-Motor Group.

SCADA (Supervision, Control and Data Acquisition).

This application can be combined with other applications of transmission/distribution systems and loads systems areas. Some examples of recommended configurations are shown at the end of this catalogue.

Some practical possibilities:

- 1.- Manual/automatic frequency control of the synchronous generator.
- 2.- Manual/automatic current excitation control of the synchronous generator.
- 3.- Manual/automatic generation output control of the synchronous generator.
- 4.- Manual/automatic power factor control of the synchronous generator.
- 5.- Manual/automatic power flows control of the synchronous generator.
- 6.- Logic operations of disconnectors and circuit breakers of a generation substation.

AEL-GCM- Manual Control Generation Systems options:

We offer modular applications focused on the basic study of electrical generators. The objective is to familiarize the student with the main operations performed in the electrical generators, controlling all the parameters of the turbine-generator group manually.

There are different topics included, depending on the application:

- Study of generation substations with manual control of synchronous generator, synchronization and protections.
- Study of generation substations with manual control of synchronous generator and synchronization.
- Study of generation substations and synchronization with servomotor as prime mover.
- Study of generation substations with manual control of synchronous generator in isolated grids and protections.
- Study of generation substations with manual control of synchronous generator in isolated grids.

All applications include SCADA (Supervision, Control and Data Acquisition).

AEL-GCM- Manual Control Generation Systems options	
<u>Applications</u>	
Synchronization Studies	
AEL-GCM-P-02S.	Generation System with Manual Control of Synchronous Generator, Synchronization and Protection Relays, with SCADA.
AEL-GCM-02S.	Generation System with Manual Control of Synchronous Generator and Synchronization, with SCADA.
AEL-GCM-P-03S.	Manual Synchronization System of Synchronous Generator with Servomotor and Protection Relays, with SCADA.
AEL-GCM-03S.	Manual Synchronization System of Synchronous Generator with Servomotor, with SCADA.
Isolated Grid Studies	
AEL-GCM-P-01S.	Generation System with Manual Control of Synchronous Generator in an Isolated Grid and Protection Relays, with SCADA.
AEL-GCM-01S.	Generation System with Manual Control of Synchronous Generator in an Isolated Grid, with SCADA.

Applications

AEL-GCM-P-02S. Generation System with Manual Control of Synchronous Generator, Synchronization and Protection Relays, with SCADA

The AEL-GCM-P-02S is a modular application designed to study the generation systems with manual control of synchronous generator, protection relays and the necessary operations for synchronization with the mains.

This application includes a SCADA System for remote control operations.

This application represents an actual generation substation with double bus bar configuration, one synchronous generator and the electrical network in order to make the synchronization operations. Besides, this application includes a series of protection relays to study different electrical faults.

This application includes:

Modules:

- N-ALI01. Industrial Main Power Supply.
- N-BUS01. Generation Busbar.
- N-BUS02. Coupling Busbar.
- N-BUS03. Grid Busbar.
- N-AVR/P. Automatic Voltage Regulator.
- N-EALD. Network Analyzer Unit with Computer Data Acquisition. (2 units)
- N-EALDC/G. DC Generator Analyzer.
- N-ASY3PH. Three-Phase Automatic Synchronoscope.
- N-WCA5K. 5KW Motor Speed Controller.
- N-PLC01. PLC01 Control Module.
- N-ERP-SFT01. Overcurrent Protection Relay Module.
- N-ERP-PDF01. Differential Protection Relay Module.
- N-ERP-MF01. Digital Fault Simulator Module.
- N-TRANS3/5KSU. 5KW Three-Phase Step-Up Transformer Module.

Transformers:

- TRANS3/5KGR. 5KW Three-Phase Grid Transformer.
- TRANS3/5KSU. 5KW Three-Phase Step-Up Transformer.

Generators:

- GMG4.5K3PH. 4.5KW Generator-Motor Group.

SCADA (Supervision, Control and Data Acquisition).

This application can be combined with other applications of transmission/distribution systems and loads systems areas. Some examples of recommended configurations are shown at the end of this catalogue.

Some practical possibilities:

- 1.- Manual frequency control of the synchronous generator.
- 2.- Manual current excitation control of the synchronous generator.
- 3.- Manual generation output control of the synchronous generator.
- 4.- Manual power factor control of the synchronous generator.
- 5.- Manual power flows control of the synchronous generator.
- 6.- Logic operations of disconnectors and circuit breakers of a generation substation.
- 7.- Manual operation for synchronization of the synchronous generator with the mains.
- 8.- Synchronoscope use for measuring mismatch voltages, frequencies and voltage modules.
- 9.- Studying of the following protection relays: the overcurrent and earth fault protection relay and the differential protection relay.
- 10.- Studying of the following short circuits types:
 - Three-Phase short circuit.
 - Two-Phase short circuit.
 - Two-Phase to ground short circuit.
 - Single-Phase short circuit.
- 11.- Adjusting of protection relays depending of the situation.
- 12.- Analyzing of the electrical faults transients with a special software.

Applications**AEL-GCM-02S. Generation System with Manual Control of Synchronous Generator and Synchronization, with SCADA**

The AEL-GCM-02S is a modular application designed to study the generation systems with manual control of synchronous generator and the necessary operations for synchronization with the mains.

This application includes a SCADA System for remote control operations.

This application represents an actual generation substation with double bus bar configuration, one synchronous generator and the electrical network in order to make the synchronization operations.

This application includes:

Modules:

- N-ALI01. Industrial Main Power Supply.
- N-BUS01. Generation Busbar.
- N-BUS02. Coupling Busbar.
- N-BUS03. Grid Busbar.
- N-AVR/P. Automatic Voltage Regulator.
- N-EALD. Network Analyzer Unit with Computer Data Acquisition. (2 units)
- N-EALDC/G. DC Generator Analyzer.
- N-ASY3PH. Three-Phase Automatic Synchronoscope.
- N-WCA5K. 5KW Motor Speed Controller.
- N-PLC01. PLC01 Control Module.
- N-TRANS3/5KSU. 5KW Three-Phase Step-Up Transformer Module.

Transformers:

- TRANS3/5KGR. 5KW Three-Phase Grid Transformer.
- TRANS3/5KSU. 5KW Three-Phase Step-Up Transformer.

Generators:

- GMG4.5K3PH. 4.5KW Generator-Motor Group.

SCADA (Supervision, Control and Data Acquisition).

This application can be combined with other applications of transmission/distribution systems and loads systems areas. Some examples of recommended configurations are shown at the end of this catalogue.

Some practical possibilities:

- 1.- Manual frequency control of the synchronous generator.
- 2.- Manual current excitation control of the synchronous generator.
- 3.- Manual generation output control of the synchronous generator.
- 4.- Manual power factor control of the synchronous generator.
- 5.- Manual power flows control of the synchronous generator.
- 6.- Logic operations of disconnectors and circuit breakers of a generation substation.
- 7.- Manual operation for synchronization of the synchronous generator with the mains.
- 8.- Synchronoscope use for measuring mismatch voltages, frequencies and voltage modules.

AEL-GCM-P-03S. Manual Synchronization System of Synchronous Generator with Servomotor and Protection Relays, with SCADA

The AEL-GCM-P-03S is a modular application designed to study the generation systems with manual control of synchronous generator and the necessary operations for synchronization with the mains.

The speed of generator-motor group is controlled by means of servomotor.

Besides, this application includes a series of protection relays in order to make different short circuit tests.

This application includes a SCADA System for remote control operations.

This application represents an actual generation substation with double bus bar configuration, one synchronous generator moved by mean of servomotor and the electrical network in order to make the synchronization operations.

This application can be combined with other applications of transmission/distribution systems and loads systems areas. Some examples of recommended configurations are shown at the end of this catalogue.

Some practical possibilities:

- 1.- Manual frequency control of the synchronous generator.
- 2.- Manual current excitation control of the synchronous generator.
- 3.- Manual generation output control of the synchronous generator.
- 4.- Manual power factor control of the synchronous generator.
- 5.- Manual power flows control of the synchronous generator.
- 6.- Logic operations of disconnectors and circuit breakers of a generation substation.
- 7.- Manual operation for synchronization of the synchronous generator with the mains.
- 8.- Synchronoscope use for measuring mismatch voltages, frequencies and voltage modules.
- 9.- Studying of the following protection relays: differential protection relay of the step-up transformer and the generator protection relay.
- 10.- Studying of the following short circuits types:
 - Three-Phase short circuit.
 - Two-Phase short circuit.
 - Two-Phase to ground short circuit.
 - Single-Phase short circuit.
- 11.- Adjusting of protection relay depending of the situation.
- 12.- Analyzing of the electrical faults transients with a special software.

Applications**AEL-GCM-03S. Manual Synchronization System of Synchronous Generator with Servomotor, with SCADA**

The AEL-GCM-03S is a modular application designed to study the generation systems with manual control of synchronous generator and the necessary operations for synchronization with the mains. The speed of generator-motor group is controlled by means of servomotor.

This application includes a SCADA System for remote control operations.

This application represents an actual generation substation with double bus bar configuration, one synchronous generator moved by mean of servomotor and the electrical network in order to make the synchronization operations.

This application can be combined with other applications of transmission/distribution systems and loads systems areas. Some examples of recommended configurations are shown at the end of this catalogue.

Some practical possibilities:

- 1.- Manual frequency control of the synchronous generator.
- 2.- Manual current excitation control of the synchronous generator.
- 3.- Manual generation output control of the synchronous generator.
- 4.- Manual power factor control of the synchronous generator.
- 5.- Manual power flows control of the synchronous generator.
- 6.- Logic operations of disconnectors and circuit breakers of a generation substation.
- 7.- Manual operation for synchronization of the synchronous generator with the mains.
- 8.- Synchronoscope use for measuring mismatch voltages, frequencies and voltage modules.

AEL-GCM-P-01S. Generation System with Manual Control of Synchronous Generator in an Isolated Grid and Protection Relays, with SCADA

The AEL-GCM-P-01S is a modular application designed to study the generation systems with manual control of synchronous generator in an isolated grid and protection relays, with SCADA.

This application represents an actual generation substation with double bus bar configuration, one synchronous generator and different protection relays to study electrical faults.

This application includes:

Modules:

- N-ALI01. Industrial Main Power Supply.
- N-BUS01. Generation Busbar.
- N-BUS02. Coupling Busbar.
- N-AVR/P. Automatic Voltage Regulator.
- N-EALD. Network Analyzer Unit with Computer Data Acquisition.
- N-EALDC/G. DC Generator Analyzer.
- N-VCA5K. 5KW Motor Speed Controller.
- N-PLC01. PLC01 Control Module.
- N-ERP-PDF01. Differential Protection Relay Module.
- N-ERP-MF01. Digital Fault Simulator Module.
- N-TRANS3/5KSU. 5KW Three-Phase Step-Up Transformer Module.

Transformers:

- TRANS3/5KSU. 5KW Three-Phase Step-Up Transformer.

Generators:

- GMG4.5K3PH. 4.5KW Generator-Motor Group.

SCADA (Supervision, Control and Data Acquisition).

This application can be combined with other applications of transmission/distribution systems and loads systems areas. Some examples of recommended configurations are shown at the end of this catalogue.

Some practical possibilities:

- 1.- Manual frequency control of the synchronous generator.
- 2.- Manual current excitation control of the synchronous generator.
- 3.- Manual generation output control of the synchronous generator.
- 4.- Manual power factor control of the synchronous generator.
- 5.- Manual power flows control of the synchronous generator.
- 6.- Logic operations of disconnectors and circuit breakers of a generation substation.
- 7.- Studying of the following protection relay: differential protection relay.
- 8.- Studying of the following short circuits types:
 - Three-Phase short circuit.
 - Two-Phase short circuit.
 - Two-Phase to ground short circuit.
 - Single-Phase short circuit.
- 9.- Adjusting of protection relay depending of the situation.
- 10.- Analyzing of the electrical faults transients with a special software.

Applications**AEL-GCM-01S. Generation System with Manual Control of Synchronous Generator in an Isolated Grid, with SCADA**

The AEL-GCM-01S is a modular application designed to study the generation systems with manual control of synchronous generator in an isolated grid, with SCADA.

This application represents an actual generation substation with double bus bar configuration and one synchronous generator.

This application includes:

Modules:

- N-ALI01. Industrial Main Power Supply.
- N-BUS01. Generation Busbar.
- N-BUS02. Coupling Busbar.
- N-AVR/P. Automatic Voltage Regulator.
- N-EALD. Network Analyzer Unit with Computer Data Acquisition.
- N-EALDC/G. DC Generator Analyzer.
- N-WCA5K. 5KW Motor Speed Controller.
- N-PLC01. PLC01 Control Module.
- N-TRANS3/5KSU. 5KW Three-Phase Step-Up Transformer Module.

Transformers:

- TRANS3/5KSU. 5KW Three-Phase Step-Up Transformer.

Generators:

- GMG4.5K3PH. 4.5KW Generator-Motor Group.

SCADA (Supervision, Control and Data Acquisition).

This application can be combined with other applications of transmission/distribution systems and loads systems areas. Some examples of recommended configurations are shown at the end of this catalogue.

Some practical possibilities:

- 1.- Manual frequency control of the synchronous generator.
- 2.- Manual current excitation control of the synchronous generator.
- 3.- Manual generation output control of the synchronous generator.
- 4.- Manual power factor control of the synchronous generator.
- 5.- Manual power flows control of the synchronous generator.
- 6.- Logic operations of disconnectors and circuit breakers of a generation substation.

AEL-GAD- Additional Generation Systems options:

They are additional modular applications focused on the study of different generation power plants, such as pumping power systems, energy recovery systems in the event of black-outs, power generation systems with two generators in parallel and hydroelectric generation systems.

The objective is to familiarize the student with the control devices employed in this type of systems nowadays.

These applications can work individually or be complemented with other applications of generation, power transmission and loads.

These applications allow to perform either a direct local control on each module or to control the entire application with the SCADA.

There are different topics included, depending on the application:

- Pumping Power Plant.
- Diesel generator with auto-start for the recovery of the energy in the event of black-outs.
- Automatic generation system with two generators in parallel.
- Hydroelectric Power Plant.

All applications include SCADA (Supervision, Control and Data Acquisition).

AEL-GAD- Additional Generation Systems options	
<u>Applications</u>	
AEL-GAD-01S.	Pumping Power Plant, with SCADA.
AEL-GAD-02S.	Auto-Start Diesel Generator Trainer for Recovery of the Energy System due to Black-Outs, with SCADA .
AEL-GAD-03S.	Automatic Generation System with Two Parallel Generators, with SCADA.
AEL-GAD-04S.	Hydroelectric Power Plant, with SCADA.

Applications

AEL-GAD-01S. Pumping Power Plant, with SCADA

The AEL-GAD-01S is a modular application designed to study the pumped storage power stations.

This application has a SCADA Control Software to simulate how the electrical energy is stored and how the potential energy of water is converted into electrical power which is then fed back into the grid.

Some practical possibilities:

- 1.- How pumped storage power plants operate.
- 2.- Start and synchronisation of synchronous machines.
- 3.- Manual power regulation: both in generator and motor modes.
- 4.- Semi-automatic active and reactive power control.
- 5.- Smart grid integration of pumped storage power plants.
- 6.- Fully-automatic compensation for externally measured active and reactive power.
- 7.- SCADA open and closed-loop system control.

AEL-GAD-02S. Auto-Start Diesel Generator Trainer for Recovery of the Energy System due to Black-Outs, with SCADA

The AEL-GAD-02S is a modular system designed to study the recovery of the energy of the electrical grid due to black-outs.

It includes a diesel generator used to supply the energy needed when the electrical grid is disconnected.

Besides, this system includes SCADA System with which the student will control different maneuvers.

Some practical possibilities:

- 1.- Simulation of black-out.
- 2.- Recovery of the power when a black-out appear.
- 3.- Controlling of a diesel-generator.
- 4.- Automatic starting of diesel-generator and coupling to the grid.

AEL-GAD-03S. Automatic Generation System with Two Parallel Generators, with SCADA

The AEL-GAD-03S is a modular application designed to study how two parallel generators work.

It includes two voltage and frequency controllers to study the most important operations carried out to control the synchronous generator.

This application has a SCADA Control System to monitor all control process of the electrical machines.

Some practical possibilities:

- 1.- Manual/automatic frequency control of the synchronous generators in parallel operation.
- 2.- Manual/automatic current excitation control of the synchronous generator.
- 3.- Manual/automatic generation output control of the synchronous generators in parallel operation.
- 4.- Manual/automatic power factor control of the synchronous generators in parallel and isolated operation.
- 5.- Manual/automatic power flows control of the synchronous generators in parallel and isolated operation.
- 6.- Manual/automatic operation for synchronization of the synchronous generator with the mains.
- 7.- Load sharing of two parallel generators.
- 8.- Active power load sharing with two parallel generators.
- 9.- Reactive power load sharing with two parallel generators.

AEL-GAD-04S. Hydroelectric Power Plant, with SCADA

The AEL-GAD-04S is a modular application designed to study the Hydroelectric Power Plants.

On this application the students will learn how hydroelectric power plants work. In order to simulate the main operations of these alternative power systems, with a motor driving a slip ring three-phase asynchronous motor will be simulate the main operations of these power systems.

This application includes a SCADA Control System in order to carry out remote control operations as open and close circuit breakers, monitoring all electrical parameters as active and reactive power, currents, voltages, etc.

This application includes:

Modules:

- N-ALI01. Industrial Main Power Supply.
- N-BUS03. Grid Busbar.
- N-EALD. Network Analyzer Unit with Computer Data Acquisition.
- N-WCA5K. 5KW Motor Speed Controller.
- N-PLC06. PLC06 Control Module.

Generators:

- GMG1.5K3PH. 1.5KW Slip Ring Generator-Motor Group.

SCADA (Supervision, Control and Data Acquisition).

Some practical possibilities:

- 1.- How hydroelectric power plants operate.
- 2.- Start and synchronisation of synchronous machines.
- 3.- Manual power regulation.
- 4.- Manual active and reactive power control.
- 5.- Automatic active and reactive power control.
- 6.- Smart grid integration of hydroelectric power plants.
- 7.- Fully-automatic compensation for externally measured active and reactive power.
- 8.- SCADA open and closed-loop system control.

2. TRANSMISSION/DISTRIBUTION SYSTEMS



The transmission/distribution systems area has been designed to provide the student the required knowledge for operating energy transmission systems.

Main features of the Transmission/Distribution Systems:

- Modular and configurable applications.
- Possibility to work either with individual applications or combined applications to form systems simulators (Generation + Transmission/Distribution + Loads).
- All applications include SCADA (Supervision, Control and Data Acquisition), Electrical Workbench and PC.

Main Transmission/Distribution Systems options:

- AEL-T. Transmission and Distribution Power Systems options.

AEL-T- Transmission and Distribution Power Systems options:

We offer modular applications focused on the study of the power distribution and transmission systems.

Starting from simple transmission systems we can upgrade with complex devices, such as protection relays, aerial lines in parallel, transformers with voltage regulation, meshed network systems, etc.

There are different topics included, depending on the application:

- Study of transmission and distribution power systems with regulation transformer.
- Study of transmission and distribution power systems with regulation transformer and protection relays.
- Transmission and distribution power systems with two aerial lines in parallel.
- Transmission and distribution power systems with two aerial lines in parallel and protections.
- Power flow control in meshed networks.
- Electrical distribution grids.

All applications include SCADA (Supervision, Control and Data Acquisition).

AEL-T- Transmission and Distribution Power Systems options

Applications

One Line and Regulation Transformer Studies

- AEL-T-P-01S. **Transmission and Distribution Power Systems with Regulation Transformer and Protection Relays, with SCADA.**
- AEL-T-01S. **Transmission and Distribution Power Systems with Regulation Transformer, with SCADA.**

Two Aerial Lines Studies

- AEL-T-P-02S. **Transmission and Distribution Power Systems with Two Aerial Parallel Lines and Protection Relays, with SCADA.**
- AEL-T-02S. **Transmission and Distribution Power Systems with Two Aerial Parallel Lines, with SCADA.**

Additional Studies Possibilities

- AEL-T-P-04S. **Electrical Distribution Grids Trainer with Protections Relays, with SCADA.**
- AEL-T-04S. **Electrical Distribution Grids Trainer, with SCADA.**
- AEL-T-03S. **Power Flow Control in Meshed Networks, with SCADA.**

Applications

AEL-T-P-01S. **Transmission and Distribution Power Systems with Regulation Transformer and Protection Relays, with SCADA**

The AEL-T-P-01S is a modular application designed to study the transmission/distribution energy systems with voltage regulation transformer and protection relays.

The AEL-T-P-01S includes a series of modules such as busbars, transmission line module, distribution transformer with voltage regulator (TAP), distance protection relay and network analyzers to study different principles of the transmission and distribution systems.

This application includes SCADA System to control different elements.

This application includes:

Modules:

- N-ALI01. Industrial Main Power Supply.
- N-BUS04. Emitter Transport Busbar.
- N-BUS05. Receptor Transport Busbar.
- N-EALD. Network Analyzer Unit with Computer Data Acquisition. (2 units)
- N-PLC02. PLC02 Control Module.
- N-REG15. Tap Module Regulator.
- N-AE1CD. Transmission Lines Simulator Digital Unit.
- N-ERP-PD01. Distance Protection Relay Module.
- N-ERP-MF01. Digital Fault Simulator Module.

Transformers:

- TRANS3/5KR. 5KW Step-Down Transformer with voltage regulator.

SCADA (Supervision, Control and Data Acquisition).

This application can be combined with other applications of generation systems and loads systems areas. Some examples of recommended configurations are shown at the end of this catalogue.

Some practical possibilities:

Local control:

- 1.- Opening and closing basic maneuvers of isolator switches and circuit breaker.
 - 2.- Measurements of energy losses in the transmission line.
 - 3.- Droop voltage compensation with the voltage regulator TAP.
 - 4.- Real time measurements of the electrical parameters (voltage, current, frequency, power factor, active power, reactive power, aparent power, active energy, reactive energy, aparent energy, etc.).
 - 5.- Studying of the energy losses of the transmission line.
 - 6.- Studying of the droop voltages in the transmission line in function on the load system.
 - 7.- Automatic configuration of the line parameters.
 - 8.- Automatic selection of the line to line capacitive effect.
 - 9.- Automatic selection of line resistor.
 - 10.- Automatic selection of line inductance.
 - 11.- Simulation of one phase loss.
 - 12.- Simulation of two phases loss.
 - 13.- Studying of short circuits in different points of transmission power system:
 - a. Symmetric short circuits: three-phase short circuits with and without contact impedance.
 - b. Asymmetric faults:
 - i. Two-phase short circuit with and without contact impedance.
 - ii. Two-phase to ground shortcircuit with and without contact impedance.
 - iii. Single-phase short circuit with and without contact impedance.
 - 14.- Recording the evolution of voltage and current phasors during short circuit for further analysis.
 - 15.- Calculation of the electrical parameters of the line to configure the distance protection relay (mho characteristic).
 - 16.- Studying in depth of the distance protection relay.
- Remote control (with SCADA):
- 17.- Supervision, Control and Data Acquisition of all electrical parameters of the transmission line.
 - 18.- Monitoring of energy losses of transmission lines from the PC.
 - 19.- Remotely control of distribution transformer voltage regulator (TAP). Compensation of droop voltages of the transmission line.
 - 20.- Studying of energy losses of the transmission line.
 - 21.- Remote measurement of droop voltages in the transmission line in function on the system load.
 - 22.- Remote automatic configuration of the transmission line impedance.
 - 23.- Remote automatic selection of the line to line capacitive effect of the transmission line.
 - 24.- Remote automatic selection of the line resistor of the transmission line.
 - 25.- Remote automatic selection of the line inductance of the transmission line.
 - 26.- Remote automatic selection of one line phase loss.
 - 27.- Remote automatic selection of two line phases loss.

Continue...

2. TRANSMISSION/DISTRIBUTION SYSTEMS

Applications

AEL-T-P-01S. **Transmission and Distribution Power Systems with Regulation Transformer and Protection Relays, with SCADA** (continuation)

Some practical possibilities (continuation):

- 28.- Remotely control of short circuits in different points of the transmission power system:
 - a. Symmetric short circuits: three-phase short circuits with and without contact impedance.
 - b. Asymmetric faults:
 - i. Two-phase short circuit with and without contact impedance.
 - ii. Two-phase to ground shortcircuit with and without contact impedance.
 - iii. Single-phase short circuit with and without contact impedance.
- 29.- Short circuits temporal evolution recording of voltage and currents phasors for further analysis.
- 30.- Calculation of the electrical parameters of the transmission line for subsequent configuration of the distance relay (mho characteristic).
- 31.- Studying in depth of the distance protection relay.

AEL-T-01S. **Transmission and Distribution Power Systems with Regulation Transformer, with SCADA**

The AEL-T-01S is a modular application designed to study the transmission/distribution energy systems with voltage regulation transformer.

The AEL-T-01S includes a series of modules such as busbars, transmission line module, distribution transformer with voltage regulator (TAP) and network analyzers to study different principles of the transmission and distribution systems.

This application includes SCADA System to control different elements.

This application includes:

Modules:

- N-ALI01. Industrial Main Power Supply.
- N-BUS04. Emitter Transport Busbar.
- N-BUS05. Receptor Transport Busbar.
- N-EALD. Network Analyzer Unit with Computer Data Acquisition. (2 units)
- N-PLC02. PLC02 Control Module.
- N-REG15. Tap Regulator Module.
- N-AE1CD. Commutable Transmission Line Simulation Unit.

Transformers:

- TRANS3/5KR. 5kW Step-Down Transformer with voltage regulator.

SCADA (Supervision, Control and Data Acquisition).

This application can be combined with other applications of generation systems and loads systems areas. Some examples of recommended configurations are shown at the end of this catalogue.

Some practical possibilities:

- 1.- Open and close basic maneuvers with disconnectors and circuit breakers.
- 2.- Measurement of energy losses in the transmission line.
- 3.- Drop voltage compensation with the voltage regulator of the distribution transformer (TAP).
- 4.- Real time measurement of the electrical parameters of the system.
- 5.- Studying of the energy losses in the transmission line.
- 6.- Studying of the drop voltage in function on the line currents.

Applications

AEL-T-P-02S. **Transmission and Distribution Power Systems with Two Aerial Parallel Lines and Protection Relays, with SCADA**

The AEL-T-P-02S is a modular application designed to study the transmission/distribution energy systems with two aerial parallel lines and protection relays.

The AEL-T-P-02S includes a series of modules such as busbars, transmission line module, distance protection relay and network analyzers to study different principles of the transmission lines working in series and parallel.

This application includes SCADA System to control different elements.

This application can be combined with other applications of generation systems and loads systems areas. Some examples of recommended configurations are shown at the end of this catalogue.

Some practical possibilities:

- 1.- Open and close basic maneuvers with disconnectors and circuit breakers.
- 2.- Measurement of energy losses in the transmission line.
- 3.- Real time measurement of the electrical parameters of the system.
- 4.- Studying of the energy losses in the transmission lines.
- 5.- Studying of the drop voltage in function on the line currents.
- 6.- Distribution of power and current among parallel-connected lines of equal length.
- 7.- Distribution of power and current among parallel-connected lines of unequal length.
- 8.- Distribution of power and current among series-connected lines of equal length.
- 9.- Distribution of power and current among series-connected lines of unequal length.
- 10.- Load distribution, power flow.
- 11.- Voltage distribution.
- 12.- Studying of short circuits:
 - Three-Phase short circuit.
 - Single-Phase short circuit.
 - Two-Phase short circuit.
- 14.- Recording of voltage and current phasors evolution during the short circuits for further analysis.
- 15.- Real time measurement of the electrical parameters of the system.
- 16.- Studying of the energy losses in the transmission line.
- 17.- Studying of the drop voltage in function on the line currents.

AEL-T-02S. **Transmission and Distribution Power Systems with Two Aerial Parallel Lines, with SCADA**

The AEL-T-02S is a modular application designed to study the transmission/distribution energy systems with two aerial parallel lines.

The AEL-T-02S includes a series of modules such as busbars, transmission line module and network analyzers to study different principles of the transmission lines working in series and parallel.

This application includes SCADA System to control different elements.

This application can be combined with other applications of generation systems and loads systems areas. Some examples of recommended configurations are shown at the end of this catalogue.

Some practical possibilities:

- 1.- Open and close basic maneuvers with disconnectors and circuit breakers.
- 2.- Measurement of energy losses in the transmission line.
- 3.- Real time measurement of the electrical parameters of the system.
- 4.- Studying of the energy losses in the transmission lines.
- 5.- Studying of the drop voltage in function on the line currents.
- 6.- Distribution of power and current among parallel-connected lines of equal length.
- 7.- Distribution of power and current among parallel-connected lines of unequal length.
- 8.- Distribution of power and current among series-connected lines of equal length.
- 9.- Distribution of power and current among series-connected lines of unequal length.
- 10.- Load distribution, power flow.
- 11.- Voltage distribution.

AEL-T-P-04S. **Electrical Distribution Grids Trainer with Protections Relays, with SCADA**

The AEL-T-P-04S is a modular application designed to study switching operations and protection relays in the double busbar used in the electrical substations.

With this application the student will learn the most important maneuvers carried out in the substations busbars.

The AEL-T-P-04S includes a series of modules such as busbar with incoming/outgoing feeder, loads, protection relays and network analyzers to study different principles of the distribution networks.

The double busbar model incorporates all functions of practical relevance. On this application are integrated instruments for measuring currents and voltages which permit direct analyses of switching operations.

This application includes SCADA System to control different substation elements.

This application can be combined with other applications of generation systems and loads systems areas. Some examples of recommended configurations are shown at the end of this catalogue.

Some practical possibilities:

- 1.- Basic circuits of a three-pole, double busbar system with incoming/ outgoing feeder.
- 2.- Three-phase, double busbar system with load.
- 3.- Busbar changeover without interruption of the branch.
- 4.- Preparation of algorithms for various switching operations.
- 5.- Busbar coupling.
- 6.- Studying of different short circuits in the busbars.

Applications

AEL-T-04S. **Electrical Distribution Grids Trainer, with SCADA**

The AEL-T-04S is a modular application designed to study the double busbar configuration used in the electrical substations.

With this application the student will learn the most important maneuvers carried out in the substations busbars.

The AEL-T-04S includes a series of modules such as busbar with incoming/outgoing feeder, loads and network analyzers to study different principles of the distribution networks.

The double busbar model incorporates all functions of practical relevance. On this application are integrated instruments for measuring currents and voltages which permit direct analyses of switching operations.

This application includes SCADA System to control different substation elements.

This application can be combined with other applications of generation systems and loads systems areas. Some examples of recommended configurations are shown at the end of this catalogue.

Some practical possibilities:

- 1.- Basic circuits of a three-pole, double busbar system with incoming/outgoing feeder.
- 2.- Three-phase, double busbar system with load.
- 3.- Busbar changeover without interruption of the branch.
- 4.- Preparation of algorithms for various switching operations.
- 5.- Busbar coupling.

AEL-T-03S. **Power Flow Control in Meshed Networks, with SCADA**

The AEL-T-03S is a modular application designed to study the power flow control in meshed networks.

The AEL-T-03S includes a series of modules such as transmission line modules, loads and network analyzers to study different principles of the power flows in meshed networks.

This application includes SCADA System to control different elements.

This application can be combined with other applications of generation systems and loads systems areas. Some examples of recommended configurations are shown at the end of this catalogue.

3. LOADS SYSTEMS



The loads systems area has been designed to provide all the knowledge related with operation of loads systems required: control of the reactive power, protection systems used in the “feeders”, request against bad changes, etc.

Main features of the Load Systems:

- Modular and configurable applications.
- Possibility to work either with individual applications or combined applications to form systems simulators (Generation + Transmission/Distribution + Loads).
- All applications include SCADA (Supervision, Control and Data Acquisition), Electrical Workbench and PC.

Main Load Systems options:

- AEL-C- Conventional Loads options.
- AEL-CS- Special Loads options.

AEL-C- Conventional Loads options:

We offer modular applications focused on the study of the final loads energy management in a power system.

Starting from basic applications, in which the regulation of the reactive power is studied manually, we can upgrade to applications in which advanced control devices for the reactive power, protection systems, etc, are included.

There are different topics included, depending on the application:

- Study of the power correction devices employed nowadays. Startup and check of an automatic power factor controller.
- Study of the “feeder” overcurrent protection relay by injecting faults in final loads systems.
- Study of the different power factors depending on the type of load connected to the grid and manual compensation of the reactive power based on previous theoretical calculations.

All applications include SCADA (Supervision, Control and Data Acquisition).

AEL-C- Conventional Loads options

Applications

- AEL-C-P-02S. **Load Systems with Automatic Power Factor Compensation and Protection Relays, with SCADA.**
- AEL-C-02S. **Load Systems with Automatic Power Factor Compensation, with SCADA.**
- AEL-C-P-01S. **Loads Systems with Manual Power Factor Compensation and Protection Relays, with SCADA.**
- AEL-C-01S. **Loads Systems with Manual Power Factor Compensation, with SCADA.**

3. LOADS SYSTEMS

Applications

AEL-C-P-02S. Load Systems with Automatic Power Factor Compensation and Protection Relays, with SCADA

The AEL-C-P-02S is a modular application designed to study automatic reactive power compensation controllers and protection relays in a feeder. With this application the student will learn to calculate the required capacitor banks in function on the demanded reactive energy.

Besides, the theory will be compared with an actual power factor controller.

The AEL-C-P-02S includes a series of modules such as automatic reactive power controller, capacitor banks, resistor loads, inductor loads, feeder manager protection relay and network analyzers to study different principles of the energy quality, power factor compensation, short circuits, etc.

The feeder protection relay included on this application lets the student to study different faults in the distribution and loads systems.

This application includes a SCADA System to control different elements and analyze the energy quality.

This application includes:

Modules:

- N-ALI01. Industrial Main Power Supply.
- N-BUS06. Distribution Busbar.
- N-EALD. Network Analyzer Unit with Computer Data Acquisition.
- N-CFP. Advanced Power Factor Controller Module.
- N-PLC03. PLC03 Control Module.
- N-CAR19T4D. Three-Phase Digital Capacitor Banks Module.
- N-CAR36T3D. Three-Phase Digital Bank of Commutable Inductances Module.
- N-CAR35T3D. Three-Phase Digital Bank Resistors Module.
- N-CAR19T3D. Three-Phase Digital Bank of Commutable Capacitors Module.
- N-ERP-MA01. Feeder Management Relay Module.
- N-ERP-MF01. Digital Fault Simulator Module.

SCADA (Supervision, Control and Data Acquisition).

This application can be combined with other applications of generation systems and transmission/distribution systems areas. Some examples of recommended configurations are shown at the end of this catalogue.

Some practical possibilities:

Local control:

- 1.- Opening and closing basic maneuvers of isolator switches and circuit breaker of distribution substation.
 - 2.- Real time measurements of all electrical parameters of the distribution systems.
 - 3.- Studying of short circuits in different points of load power system:
 - a. Symmetric short circuits: three-phase short circuits with and without contact impedance.
 - b. Asymmetric faults:
 - i. Two-phase short circuit with and without contact impedance.
 - ii. Two-phase to ground shortcircuit with and without contact impedance.
 - iii. Single-phase short circuit with and without contact impedance.
 - 4.- Recording the evolution of voltage and current phasors during short circuit for further analysis.
 - 5.- Studying in depth of feeder protection relay.
- Remote control (with SCADA System):
- 6.- Supervision, Control and Data Acquisition of all electrical parameters of the load distribution system.
 - 7.- Remote control of the demanded active power.
 - 8.- Remote control of the demanded inductive reactive power.
 - 9.- Remote control of the demanded capacitive reactive power.
 - 10.- Remote measurement of all electrical parameters of load distribution system.
 - 11.- Remotely control of short circuits in different points of the load power system:
 - a. Symmetric short circuits: three-phase short circuits with and without contact impedance.
 - b. Asymmetric faults:
 - i. Two-phase short circuit with and without contact impedance.
 - ii. Two-phase to ground shortcircuit with and without contact impedance.
 - iii. Single-phase short circuit with and without contact impedance.
 - 12.- Recording the evolution of voltage and current phasors during short circuit for further analysis.
 - 13.- Studying in depth of feeder protection relay.
 - 14.- Automatic power factor compensation in function on the demanded reactive energy.

Continue...

3. LOADS SYSTEMS

Applications

AEL-C-02S. Load Systems with Automatic Power Factor Compensation, with SCADA

The AEL-C-02S is a modular application designed to study automatic reactive power compensation controllers.

With this application the student will learn to calculate the required capacitor banks in function on the demanded reactive energy.

Besides, the theory will be compared with an actual power factor controller.

The AEL-C-02S includes a series of modules such as automatic reactive power controller, capacitor banks, resistor loads, inductor loads and network analyzers to study different principles of the energy quality, power factor compensation, etc.

This application includes a SCADA System to control different elements and analyze the energy quality.

This application includes:

Modules:

- N-ALI01. Industrial Main Power Supply.
- N-BUS06. Distribution Busbar.
- N-EALD. Network Analyzer Unit with Computer Data Acquisition.
- N-PLC03. PLC03 Control Module.
- N-CFP. Advanced Power Factor Controller Module.
- N-CAR19T4D. Three-Phase Digital Capacitor Banks Module.
- N-CAR19T3D. Three-Phase Digital Bank of Commutable Capacitors Module.
- N-CAR36T3D. Three-Phase Digital Bank of Commutable Inductances Module.
- N-CAR35T3D. Three-Phase Digital Bank Resistors Module.

SCADA (Supervision, Control and Data Acquisition).

This application can be combined with other applications of generation systems and transmission/distribution systems areas. Some examples of recommended configurations are shown at the end of this catalogue.

Some practical possibilities:

- 1.- Calculating parameters for compensation capacitors.
- 2.- Compensation using various capacitors.
- 3.- Determining stage power.
- 4.- Manual compensation of reactive power.
- 5.- Studying of the power factor controller:
 - Commissioning.
 - Programming.
 - Capacitor banks connections.
- 6.- Automatic compensation of reactive power.
- 7.- Manual compensation of reactive power.

AEL-C-P-01S. Loads Systems with Manual Power Factor Compensation and Protection Relays, with SCADA

The AEL-C-P-01S is a modular application designed to study manual reactive power compensation with feeder protection relay. With this application the student will learn to calculate the required capacitor banks in function on the demanded reactive energy.

The AEL-C-P-01S includes a series of modules such as capacitor banks, resistor loads, inductor loads, feeder protection relay and network analyzers to study different principles of the energy quality, power factor compensation, short circuits, etc.

This application includes SCADA System to control different elements and analyze the energy quality.

This application includes:

Modules:

- N-ALI01. Industrial Main Power Supply.
- N-BUS06. Distribution Busbar.
- N-EALD. Network Analyzer Unit with Computer Data Acquisition.
- N-PLC03. PLC03 Control Module.
- N-CAR19T3D. Three-Phase Digital Bank of Commutable Capacitors Module.
- N-CAR36T3D. Three-Phase Digital Bank of Commutable Inductances Module.
- N-CAR35T3D. Three-Phase Digital Bank Resistors Module.
- N-ERP-MA01. Feeder Management Relay Module.
- N-ERP-MF01. Digital Fault Simulator Module.

SCADA (Supervision, Control and Data Acquisition).

This application can be combined with other applications of generation systems and transmission/distribution systems areas. Some examples of recommended configurations are shown at the end of this catalogue.

Some practical possibilities:

- 1.- Calculating parameters for compensation capacitors.
- 2.- Compensation using various capacitors.
- 3.- Determining stage power.
- 4.- Manual compensation of reactive power.
- 5.- Studying of short circuits:
 - Three-Phase short circuit.
 - Single-Phase short circuit.
 - Two-Phase short circuit.
- 6.- Recording of voltage and current phasors evolution during the short circuits for further analysis.
- 7.- Real time measurement of the electrical parameters of the system.

Applications

AEL-C-01S. **Loads Systems with Manual Power Factor Compensation, with SCADA**

The AEL-C-01S is a modular application designed to study manual reactive power compensation. With this application the student will learn to calculate the required capacitor banks in function on the demanded reactive energy.

The AEL-C-01S includes a series of modules such as capacitor banks, resistor loads, inductor loads and network analyzers to study different principles of the energy quality, power factor compensation, etc.

This application includes SCADA System to control different elements and analyze the energy quality.

This application includes:

Modules:

- N-ALI01. Industrial Main Power Supply.
- N-BUS06. Distribution Busbar.
- N-EALD. Network Analyzer Unit with Computer Data Acquisition.
- N-PLC03. PLC03 Control Module.
- N-CAR19T3D.Three-Phase Digital Bank of Commutable Capacitors Module.
- N-CAR36T3D.Three-Phase Digital Bank of Commutable Inductances Module.
- N-CAR35T3D.Three-Phase Digital Bank Resistors Module.

SCADA (Supervision, Control and Data Acquisition).

This application can be combined with other applications of generation systems and transmission/distribution systems areas. Some examples of recommended configurations are shown at the end of this catalogue.

Some practical possibilities:

- 1.- Calculating parameters for compensation capacitors.
- 2.- Compensation using various capacitors.
- 3.- Determining stage power.
- 4.- Manual compensation of reactive power.

AEL-CS- Special Loads options:

We offer modular applications focused on the study of the dynamic loads, complex loads, consumption measurement, control of peak loads, etc.

There are different topics included, depending on the application:

- Analysis, measurement of complex loads and control of peak loads.

All applications include SCADA (Supervision, Control and Data Acquisition).

AEL-CS- Special Loads options	
<u>Applications</u>	
AEL-C-03S.	Complex Loads, Power Consumption Measurement and Peak Load Monitoring, with SCADA.

Applications

AEL-CS-03S. Complex Loads, Power Consumption Measurement and Peak Load Monitoring, with SCADA

The AEL-C-03S is a modular application designed to study the complex load, power consumption measurement and peak load monitoring.

With this application the student will learn the difference between star-delta loads connection, measurement of reactive and active energy for symmetric and asymmetric RL loads, over-compensation RC load, etc.

The AEL-C-03S includes a series of modules such as capacitor banks, resistor loads, inductor loads and network analyzers to study different principles of the complex loads.

This application includes SCADA System.

This application can be combined with other applications of generation systems and transmission/distribution systems areas. Some examples of recommended configurations are shown at the end of this catalogue.

MODULAR SMART GRID POWER SYSTEMS SIMULATORS

- RECOMMENDED SYSTEMS SIMULATORS CONFIGURATIONS -



In order to understand in depth how work actual power systems, EDIBON offers a series of "Modular Smart Grid Power Systems Simulators".

The "Modular Smart Grid Power Systems Simulators" are configured applications of generation, transmission and loads areas that has been described individually at the beginning of this catalogue.

The objective of these Power Systems Simulators is give the students different technical solutions to understand how nowadays work together the actual generation, transmission, distribution and load power systems.

Due to EDIBON provides a wide variety of applications, different applications configurations of generation, transmission/distribution and loads are recommended in order to form a "Modular Smart Grid Power Systems Simulator".

Examples of Recommended Systems Simulators Configurations:

- AEL-MPSS-01. Modular Smart Grid Power Systems Simulator, with Automatic Control Generation, Transmission Line, Loads and Protection Relays, with SCADA.
- AEL-MPSS-02. Modular Smart Grid Power Systems Simulator, with Automatic Control Generation, Transmission Line and Loads, with SCADA.
- AEL-MPSS-03. Modular Smart Grid Power Systems Simulator, with Manual Control Generation, Transmission Line, Loads and Protection Relays, with SCADA.
- AEL-MPSS-04. Modular Smart Grid Power Systems Simulator, with Manual Control Generation, Transmission Line and Loads, with SCADA.

AEL-MPSS-01. Modular Smart Grid Power Systems Simulator, with Automatic Control Generation, Transmission Line, Loads and Protection Relays, with SCADA

The AEL-MPSS-01 S is a Modular Smart Grid Power Systems Simulator designed to study how Smart Grids operate within the large actual power systems. It is one of the most comprehensive and advanced modular smart grid power systems simulator because it shows the most important operations of an entire power system, from the energy is generated until it reaches the final consumer.

This simulator consists of:

- AEL-GCA-P-02S. **Generation System with Automatic Control of Synchronous Generator, Synchronization and Protection Relays, with SCADA.**
- AEL-T-P-01S. **Transmission and Distribution Power Systems with Regulation Transformer and Protection Relays, with SCADA.**
- AEL-C-P-02S. **Loads Systems with Automatic Power Factor Compensation and Protection Relays, with SCADA.**
- **SCADA** (Supervision, Control and Data Acquisition), Workbenches and PC.

1. GENERATION SYSTEMS		
AEL-GCA- Automatic Control Generation Systems options	AEL-GCM- Manual Control Generation Systems options	AEL-GAD- Additional Generation Systems options
Applications	Applications	Applications
<p>Synchronization Studies</p> <p>AEL-GCA-P-02S. Generation System with Automatic Control of Synchronous Generator, Synchronization and Protection Relays, with SCADA.</p> <p>AEL-GCA-02S. Generation System with Automatic Control of Synchronous Generator and Synchronization, with SCADA.</p> <p>AEL-GCA-P-03S. Automatic Synchronization System of Synchronous Generator with Servomotor and Protection Relays, with SCADA.</p> <p>AEL-GCA-03S. Automatic Synchronization System of Synchronous Generator with Servomotor, with SCADA.</p> <p>Isolated Grid Studies</p> <p>AEL-GCA-P-01S. Generation System with Automatic Control of Synchronous Generator in an Isolated Grid and Protection Relays, with SCADA.</p> <p>AEL-GCA-01S. Generation System with Automatic Control of Synchronous Generator in an Isolated Grid, with SCADA.</p>	<p>Synchronization Studies</p> <p>AEL-GCM-P-02S. Generation System with Manual Control of Synchronous Generator, Synchronization and Protection Relays, with SCADA.</p> <p>AEL-GCM-02S. Generation System with Manual Control of Synchronous Generator and Synchronization, with SCADA.</p> <p>AEL-GCM-P-03S. Manual Synchronization System of Synchronous Generator with Servomotor and Protection Relays, with SCADA.</p> <p>AEL-GCM-03S. Manual Synchronization System of Synchronous Generator with Servomotor, with SCADA.</p> <p>Isolated Grid Studies</p> <p>AEL-GCM-P-01S. Generation System with Manual Control of Synchronous Generator in an Isolated Grid and Protection Relays, with SCADA.</p> <p>AEL-GCM-01S. Generation System with Manual Control of Synchronous Generator in an Isolated Grid, with SCADA.</p>	<p>AEL-GAD-01S. Pumping Power Plant, with SCADA.</p> <p>AEL-GAD-02S. Auto-Start Diesel Generator Trainer for Recovery of the Energy System due to Black-Outs, with SCADA.</p> <p>AEL-GAD-03S. Automatic Generation System with Two Parallel Generators, with SCADA.</p> <p>AEL-GAD-04S. Hydroelectric Power Plant, with SCADA.</p> <p>These applications are additional for AEL-GCA and AEL-GCM applications.</p>
2. TRANSMISSION/DISTRIBUTION SYSTEMS		
AEL-T- Transmission and Distribution Power Systems options		
Applications		
<p>One Line and Regulation Transformer Studies</p> <p>AEL-T-P-01S. Transmission and Distribution Power Systems with Regulation Transformer and Protection Relays, with SCADA.</p> <p>AEL-T-01S. Transmission and Distribution Power Systems with Regulation Transformer, with SCADA.</p> <p>Two Aerial Lines Studies</p> <p>AEL-T-P-02S. Transmission and Distribution Power Systems with Two Aerial Parallel Lines and Protection Relays, with SCADA.</p> <p>AEL-T-02S. Transmission and Distribution Power Systems with Two Aerial Parallel Lines, with SCADA.</p> <p>Additional Studies Possibilities</p> <p>AEL-T-P-04S. Electrical Distribution Grids Trainer with Protections Relays, with SCADA.</p> <p>AEL-T-04S. Electrical Distribution Grids Trainer, with SCADA.</p> <p>AEL-T-03S. Power Flow Control in Meshed Networks, with SCADA.</p>		
3. LOADS SYSTEMS (Energy Utilization)		
AEL-C- Conventional Loads options	AEL-CS- Special Loads options	
<p>AEL-C-P-02S. Loads Systems with Automatic Power Factor Compensation and Protection Relays, with SCADA.</p> <p>AEL-C-02S. Loads Systems with Automatic Power Factor Compensation, with SCADA.</p> <p>AEL-C-P-01S. Loads Systems with Manual Power Factor Compensation and Protection Relays, with SCADA.</p> <p>AEL-C-01S. Loads Systems with Manual Power Factor Compensation, with SCADA.</p>	<p>AEL-C-03S. Complex Loads, Power Consumption Measurement and Peak Load Monitoring, with SCADA.</p>	

The AEL-MPSS-01 S offers the following possibilities and others:

Studying of high voltage protection systems:

It is provided with 5 latest generation protection relays (renowned manufacturer Schweitzer Engineering Laboratories SEL) used in real electrical substations that give to AEL-MPSS-01 S a great authenticity and variety of fault tests.

It incorporates protection relays as the overcurrent protection relay, the differential protection relay for generators and transformers, the distance protection relay and the feeder protection relay.

Studying of generation substations:

It incorporates a sophisticated system for control and regulation of the turbine (prime mover) and synchronous generator that will allow the student to know how carried out the control and regulation in large groups of power generation.

It includes different bus-bars to demonstrate the main maneuvers carried out with disconnectors and circuit breakers in the generation substations.

Studying of the transmission/distribution systems:

It incorporates a transmission line module to study different events in function on the energy carried along line like energy losses, drop voltages, etc. It includes a regulation transformer and network analyzers to study the drop voltage compensation in the transmission lines.

It includes different bus-bars to demonstrate the main maneuvers carried out with disconnectors and circuit breakers in the emitter and receiver substations.

Studying of energy consumption systems:

It incorporates an automatic reactive power compensation controller that acts autonomously according to the power factor of the load. It includes different bus-bars to demonstrate the main maneuvers carried out with disconnectors and circuit breakers in the distribution substations. It incorporates different loads modules to simulate energy consumptions.

The AEL-MPSS-01 S has a SCADA System for remotely control operations.

AEL-MPSS-02. Modular Smart Grid Power Systems Simulator, with Automatic Control Generation, Transmission Line and Loads, with SCADA

The AEL-MPSS-02S is a Modular Smart Grid Power Systems Simulator designed to study how Smart Grids operate within the large actual power systems. It shows different operations of an entire power system, from the energy is generated until it reaches the final consumer.

This simulator consists of:

- AEL-GCA-02S. **Generation System with Automatic Control of Synchronous Generator and Synchronization, with SCADA.**
- AEL-T-01S. **Transmission and Distribution Power Systems with Regulation Transformer, with SCADA.**
- AEL-C-02S. **Loads Systems with Automatic Power Factor Compensation, with SCADA.**
- **SCADA** (Supervision, Control and Data Acquisition), Workbenches and PC.

1. GENERATION SYSTEMS		
AEL-GCA- Automatic Control Generation Systems options	AEL-GCM- Manual Control Generation Systems options	AEL-GAD- Additional Generation Systems options
<p><u>Applications</u></p> <p>Synchronization Studies AEL-GCA-P-02S. Generation System with Automatic Control of Synchronous Generator, Synchronization and Protection Relays, with SCADA.</p> <p>AEL-GCA-02S. Generation System with Automatic Control of Synchronous Generator and Synchronization, with SCADA.</p> <p>AEL-GCA-P-03S. Automatic Synchronization System of Synchronous Generator with Servomotor and Protection Relays, with SCADA.</p> <p>AEL-GCA-03S. Automatic Synchronization System of Synchronous Generator with Servomotor, with SCADA.</p> <p>Isolated Grid Studies AEL-GCA-P-01S. Generation System with Automatic Control of Synchronous Generator in an Isolated Grid and Protection Relays, with SCADA.</p> <p>AEL-GCA-01S. Generation System with Automatic Control of Synchronous Generator in an Isolated Grid, with SCADA.</p>	<p><u>Applications</u></p> <p>Synchronization Studies AEL-GCM-P-02S. Generation System with Manual Control of Synchronous Generator, Synchronization and Protection Relays, with SCADA.</p> <p>AEL-GCM-02S. Generation System with Manual Control of Synchronous Generator and Synchronization, with SCADA.</p> <p>AEL-GCM-P-03S. Manual Synchronization System of Synchronous Generator with Servomotor and Protection Relays, with SCADA.</p> <p>AEL-GCM-03S. Manual Synchronization System of Synchronous Generator with Servomotor, with SCADA.</p> <p>Isolated Grid Studies AEL-GCM-P-01S. Generation System with Manual Control of Synchronous Generator in an Isolated Grid and Protection Relays, with SCADA.</p> <p>AEL-GCM-01S. Generation System with Manual Control of Synchronous Generator in an Isolated Grid, with SCADA.</p>	<p><u>Applications</u></p> <p>AEL-GAD-01S. Pumping Power Plant, with SCADA.</p> <p>AEL-GAD-02S. Auto-Start Diesel Generator Trainer for Recovery of the Energy System due to Black-Outs, with SCADA.</p> <p>AEL-GAD-03S. Automatic Generation System with Two Parallel Generators, with SCADA.</p> <p>AEL-GAD-04S. Hydroelectric Power Plant, with SCADA.</p> <p>These applications are additional for AEL-GCA and AEL-GCM applications.</p>
2. TRANSMISSION/DISTRIBUTION SYSTEMS		
<p align="center">AEL-T- Transmission and Distribution Power Systems options</p> <p align="center"><u>Applications</u></p> <p>One Line and Regulation Transformer Studies AEL-T-P-01S. Transmission and Distribution Power Systems with Regulation Transformer and Protection Relays, with SCADA.</p> <p>AEL-T-01S. Transmission and Distribution Power Systems with Regulation Transformer, with SCADA.</p> <p>Two Aerial Lines Studies AEL-T-P-02S. Transmission and Distribution Power Systems with Two Aerial Parallel Lines and Protection Relays, with SCADA.</p> <p>AEL-T-02S. Transmission and Distribution Power Systems with Two Aerial Parallel Lines, with SCADA.</p> <p>Additional Studies Possibilities AEL-T-P-04S. Electrical Distribution Grids Trainer with Protections Relays, with SCADA.</p> <p>AEL-T-04S. Electrical Distribution Grids Trainer, with SCADA.</p> <p>AEL-T-03S. Power Flow Control in Meshed Networks, with SCADA.</p>		
3. LOADS SYSTEMS (Energy Utilization)		
AEL-C- Conventional Loads options	AEL-CS- Special Loads options	
<p>AEL-C-P-02S. Loads Systems with Automatic Power Factor Compensation and Protection Relays, with SCADA.</p> <p>AEL-C-02S. Loads Systems with Automatic Power Factor Compensation, with SCADA.</p> <p>AEL-C-P-01S. Loads Systems with Manual Power Factor Compensation and Protection Relays, with SCADA.</p> <p>AEL-C-01S. Loads Systems with Manual Power Factor Compensation, with SCADA.</p>	<p>AEL-C-03S. Complex Loads, Power Consumption Measurement and Peak Load Monitoring, with SCADA.</p>	

The AEL-MPSS-02S offers the following possibilities and others:

Studying of generation substations:

It incorporates a sophisticated system for control and regulation of the turbine (prime mover) and synchronous generator that will allow the student to know how carried out the control and regulation in large groups of power generation.

It includes different bus-bars to demonstrate the main maneuvers carried out with disconnectors and circuit breakers in the generation substations.

Studying of the transmission/distribution systems:

It incorporates a transmission line module to study different events in function on the transmitted energy like energy losses, drop voltages, etc. It includes a regulation transformer and network analyzers to study the drop voltage compensation in the transmission lines.

It includes different bus-bars to demonstrate the main maneuvers carried out with disconnectors and circuit breakers in the emitter and receiver substations.

Studying of energy consumption systems:

It incorporates an automatic reactive power compensation controller that acts autonomously according to the power factor of the load.

It includes different bus-bars to demonstrate the main maneuvers carried out with disconnectors and circuit breakers in the distribution substations.

It incorporates different loads modules to simulate energy consumptions.

The AEL-MPSS-02S has a SCADA System for remotely control operations.

AEL-MPSS-03. Modular Smart Grid Power Systems Simulator, with Manual Control Generation, Transmission Line, Loads and Protection Relays, with SCADA

The AEL-MPSS-03S is a Modular Smart Grid Power Systems Simulator designed to study how Smart Grids operate within the large actual power systems. It shows the most important operations of an entire power system, from the energy is generated until it reaches the final consumer.

This simulator consists of:

- AEL-GCM-P-02S. **Generation System with Manual Control of Synchronous Generator, Synchronization and Protection Relays, with SCADA.**
- AEL-T-P-01S. **Transmission and Distribution Power Systems with Regulation Transformer and Protection Relays, with SCADA.**
- AEL-C-P-01S. **Loads Systems with Manual Power Factor Compensation and Protection Relays, with SCADA.**
- **SCADA** (Supervision, Control and Data Acquisition), Workbenches and PC.

1. GENERATION SYSTEMS		
AEL-GCA- Automatic Control Generation Systems options	AEL-GCM- Manual Control Generation Systems options	AEL-GAD- Additional Generation Systems options
<p align="center"><u>Applications</u></p> <p>Synchronization Studies AEL-GCA-P-02S. Generation System with Automatic Control of Synchronous Generator, Synchronization and Protection Relays, with SCADA.</p> <p>AEL-GCA-02S. Generation System with Automatic Control of Synchronous Generator and Synchronization, with SCADA.</p> <p>AEL-GCA-P-03S. Automatic Synchronization System of Synchronous Generator with Servomotor and Protection Relays, with SCADA.</p> <p>AEL-GCA-03S. Automatic Synchronization System of Synchronous Generator with Servomotor, with SCADA.</p> <p>Isolated Grid Studies AEL-GCA-P-01S. Generation System with Automatic Control of Synchronous Generator in an Isolated Grid and Protection Relays, with SCADA.</p> <p>AEL-GCA-01S. Generation System with Automatic Control of Synchronous Generator in an Isolated Grid, with SCADA.</p>	<p align="center"><u>Applications</u></p> <p>Synchronization Studies AEL-GCM-P-02S. Generation System with Manual Control of Synchronous Generator, Synchronization and Protection Relays, with SCADA.</p> <p>AEL-GCM-02S. Generation System with Manual Control of Synchronous Generator and Synchronization, with SCADA.</p> <p>AEL-GCM-P-03S. Manual Synchronization System of Synchronous Generator with Servomotor and Protection Relays, with SCADA.</p> <p>AEL-GCM-03S. Manual Synchronization System of Synchronous Generator with Servomotor, with SCADA.</p> <p>Isolated Grid Studies AEL-GCM-P-01S. Generation System with Manual Control of Synchronous Generator in an Isolated Grid and Protection Relays, with SCADA.</p> <p>AEL-GCM-01S. Generation System with Manual Control of Synchronous Generator in an Isolated Grid, with SCADA.</p>	<p align="center"><u>Applications</u></p> <p>AEL-GAD-01S. Pumping Power Plant, with SCADA.</p> <p>AEL-GAD-02S. Auto-Start Diesel Generator Trainer for Recovery of the Energy System due to Black-Outs, with SCADA.</p> <p>AEL-GAD-03S. Automatic Generation System with Two Parallel Generators, with SCADA.</p> <p>AEL-GAD-04S. Hydroelectric Power Plant, with SCADA.</p> <p>These applications are additional for AEL-GCA and AEL-GCM applications.</p>
2. TRANSMISSION/DISTRIBUTION SYSTEMS		
<p align="center">AEL-T- Transmission and Distribution Power Systems options</p> <p align="center"><u>Applications</u></p> <p>One Line and Regulation Transformer Studies AEL-T-P-01S. Transmission and Distribution Power Systems with Regulation Transformer and Protection Relays, with SCADA.</p> <p>AEL-T-01S. Transmission and Distribution Power Systems with Regulation Transformer, with SCADA.</p> <p>Two Aerial Lines Studies AEL-T-P-02S. Transmission and Distribution Power Systems with Two Aerial Parallel Lines and Protection Relays, with SCADA.</p> <p>AEL-T-02S. Transmission and Distribution Power Systems with Two Aerial Parallel Lines, with SCADA.</p> <p>Additional Studies Possibilities AEL-T-P-04S. Electrical Distribution Grids Trainer with Protections Relays, with SCADA.</p> <p>AEL-T-04S. Electrical Distribution Grids Trainer, with SCADA.</p> <p>AEL-T-03S. Power Flow Control in Meshed Networks, with SCADA.</p>		
3. LOADS SYSTEMS (Energy Utilization)		
AEL-C- Conventional Loads options	AEL-CS- Special Loads options	
<p>AEL-C-P-02S. Loads Systems with Automatic Power Factor Compensation and Protection Relays, with SCADA.</p> <p>AEL-C-02S. Loads Systems with Automatic Power Factor Compensation, with SCADA.</p> <p>AEL-C-P-01S. Loads Systems with Manual Power Factor Compensation and Protection Relays, with SCADA.</p> <p>AEL-C-01S. Loads Systems with Manual Power Factor Compensation, with SCADA.</p>	<p>AEL-C-03S. Complex Loads, Power Consumption Measurement and Peak Load Monitoring, with SCADA.</p>	

The AEL-MPSS-03S offers the following possibilities and others:

Studying of high voltage protection systems:

It is provided with 5 latest generation protection relays (renowned manufacturer Schweitzer Engineering Laboratories SEL) used in real electrical substations that give to AEL-MPSS-03S a great authenticity. It incorporates protection relays as the overcurrent protection relay, the differential protection relay for generators and transformers, distance protection relay and feeder protection relay.

Studying of generation substations:

It incorporates a manual control system for control and regulation of the turbine (prime mover) and synchronous generator that will allow the student to know how carried out the control and regulation in large groups of power generation.

It includes different bus-bars to demonstrate the main maneuvers carried out with disconnectors and circuit breakers in the generation substations.

Studying of the transmission/distribution systems:

It incorporates a transmission line module to study different events in function on the transmitted energy like energy losses, drop voltages, etc. It includes a regulation transformer and network analyzers to study the drop voltage compensation in the transmission lines.

It includes different bus-bars to demonstrate the main maneuvers carried out with disconnectors and circuit breakers in the emitter and receiver substations.

Studying of energy consumption systems:

It includes different bus-bars to demonstrate the main maneuvers carried out with disconnectors and circuit breakers in the distribution substations. It incorporates different loads modules to simulate energy consumptions and to study the manual compensation of reactive power.

The AEL-MPSS-03S has a SCADA System for remotely control operations.

AEL-MPSS-04. Modular Smart Grid Power Systems Simulator, with Manual Control Generation, Transmission Line and Loads, with SCADA

The AEL-MPSS-04S is a Modular Power Systems Simulator designed to study how Smart Grids operate within the large actual power systems. It shows different operations of an entire power system, from the energy is generated until it reaches the final consumer.

This simulator consists of:

- AEL-GCM-02S. **Generation System with Manual Control of Synchronous Generator and Synchronization, with SCADA.**
- AEL-T-01S. **Transmission and Distribution Power Systems with Regulation Transformer, with SCADA.**
- AEL-C-01S. **Loads Systems with Manual Power Factor Compensation, with SCADA.**
- **SCADA** (Supervision, Control and Data Acquisition), Workbenches and PC.

1. GENERATION SYSTEMS		
AEL-GCA- Automatic Control Generation Systems options	AEL-GCM- Manual Control Generation Systems options	AEL-GAD- Additional Generation Systems options
<p><u>Applications</u></p> <p>Synchronization Studies AEL-GCA-P-02S. Generation System with Automatic Control of Synchronous Generator, Synchronization and Protection Relays, with SCADA.</p> <p>AEL-GCA-02S. Generation System with Automatic Control of Synchronous Generator and Synchronization, with SCADA.</p> <p>AEL-GCA-P-03S. Automatic Synchronization System of Synchronous Generator with Servomotor and Protection Relays, with SCADA.</p> <p>AEL-GCA-03S. Automatic Synchronization System of Synchronous Generator with Servomotor, with SCADA.</p> <p>Isolated Grid Studies AEL-GCA-P-01S. Generation System with Automatic Control of Synchronous Generator in an Isolated Grid and Protection Relays, with SCADA.</p> <p>AEL-GCA-01S. Generation System with Automatic Control of Synchronous Generator in an Isolated Grid, with SCADA.</p>	<p><u>Applications</u></p> <p>Synchronization Studies AEL-GCM-P-02S. Generation System with Manual Control of Synchronous Generator, Synchronization and Protection Relays, with SCADA.</p> <p>AEL-GCM-02S. Generation System with Manual Control of Synchronous Generator and Synchronization, with SCADA.</p> <p>AEL-GCM-P-03S. Manual Synchronization System of Synchronous Generator with Servomotor and Protection Relays, with SCADA.</p> <p>AEL-GCM-03S. Manual Synchronization System of Synchronous Generator with Servomotor, with SCADA.</p> <p>Isolated Grid Studies AEL-GCM-P-01S. Generation System with Manual Control of Synchronous Generator in an Isolated Grid and Protection Relays, with SCADA.</p> <p>AEL-GCM-01S. Generation System with Manual Control of Synchronous Generator in an Isolated Grid, with SCADA.</p>	<p><u>Applications</u></p> <p>AEL-GAD-01S. Pumping Power Plant, with SCADA.</p> <p>AEL-GAD-02S. Auto-Start Diesel Generator Trainer for Recovery of the Energy System due to Black-Outs, with SCADA.</p> <p>AEL-GAD-03S. Automatic Generation System with Two Parallel Generators, with SCADA.</p> <p>AEL-GAD-04S. Hydroelectric Power Plant, with SCADA.</p> <p>These applications are additional for AEL-GCA and AEL-GCM applications.</p>
2. TRANSMISSION/DISTRIBUTION SYSTEMS		
<p align="center">AEL-T- Transmission and Distribution Power Systems options</p> <p align="center"><u>Applications</u></p> <p>One Line and Regulation Transformer Studies AEL-T-P-01S. Transmission and Distribution Power Systems with Regulation Transformer and Protection Relays, with SCADA.</p> <p>AEL-T-01S. Transmission and Distribution Power Systems with Regulation Transformer, with SCADA.</p> <p>Two Aerial Lines Studies AEL-T-P-02S. Transmission and Distribution Power Systems with Two Aerial Parallel Lines and Protection Relays, with SCADA.</p> <p>AEL-T-02S. Transmission and Distribution Power Systems with Two Aerial Parallel Lines, with SCADA.</p> <p>Additional Studies Possibilities AEL-T-P-04S. Electrical Distribution Grids Trainer with Protections Relays, with SCADA.</p> <p>AEL-T-04S. Electrical Distribution Grids Trainer, with SCADA.</p> <p>AEL-T-03S. Power Flow Control in Meshed Networks, with SCADA.</p>		
3. LOADS SYSTEMS (Energy Utilization)		
AEL-C- Conventional Loads options	AEL-CS- Special Loads options	
<p>AEL-C-P-02S. Loads Systems with Automatic Power Factor Compensation and Protection Relays, with SCADA.</p> <p>AEL-C-02S. Loads Systems with Automatic Power Factor Compensation, with SCADA.</p> <p>AEL-C-P-01S. Loads Systems with Manual Power Factor Compensation and Protection Relays, with SCADA.</p> <p>AEL-C-01S. Loads Systems with Manual Power Factor Compensation, with SCADA.</p>	<p>AEL-C-03S. Complex Loads, Power Consumption Measurement and Peak Load Monitoring, with SCADA.</p>	

The AEL-MPSS-04S offers the following possibilities and others:

Studying of generation substations:

It incorporates a manual control system for control and regulation of the turbine (prime mover) and synchronous generator that will allow the student to know how carried out the control and regulation in large groups of power generation.

It includes different bus-bars to demonstrate the main maneuvers carried out with disconnectors and circuit breakers in the generation substations.

Studying of the transmission/distribution systems:

It incorporates a transmission line module to study different events in function on the transmitted energy like energy losses, drop voltages, etc.

It includes a regulation transformer and network analyzers to study the drop voltage compensation in the transmission lines.

It includes different bus-bars to demonstrate the main maneuvers carried out with disconnectors and circuit breakers in the emitter and receiver substations.

Studying of energy consumption systems:

It includes different bus-bars to demonstrate the main maneuvers carried out with disconnectors and circuit breakers in the distribution substations.

It incorporates different loads modules to simulate energy consumptions and to study the manual compensation of reactive power.

The AEL-MPSS-04S has a SCADA System for remotely control operations.

Modular Smart Grid Power Systems Simulator, with Automatic Control Generation, Transmission Line, Loads and Protection Relays, with SCADA

AEL-MPSS-01

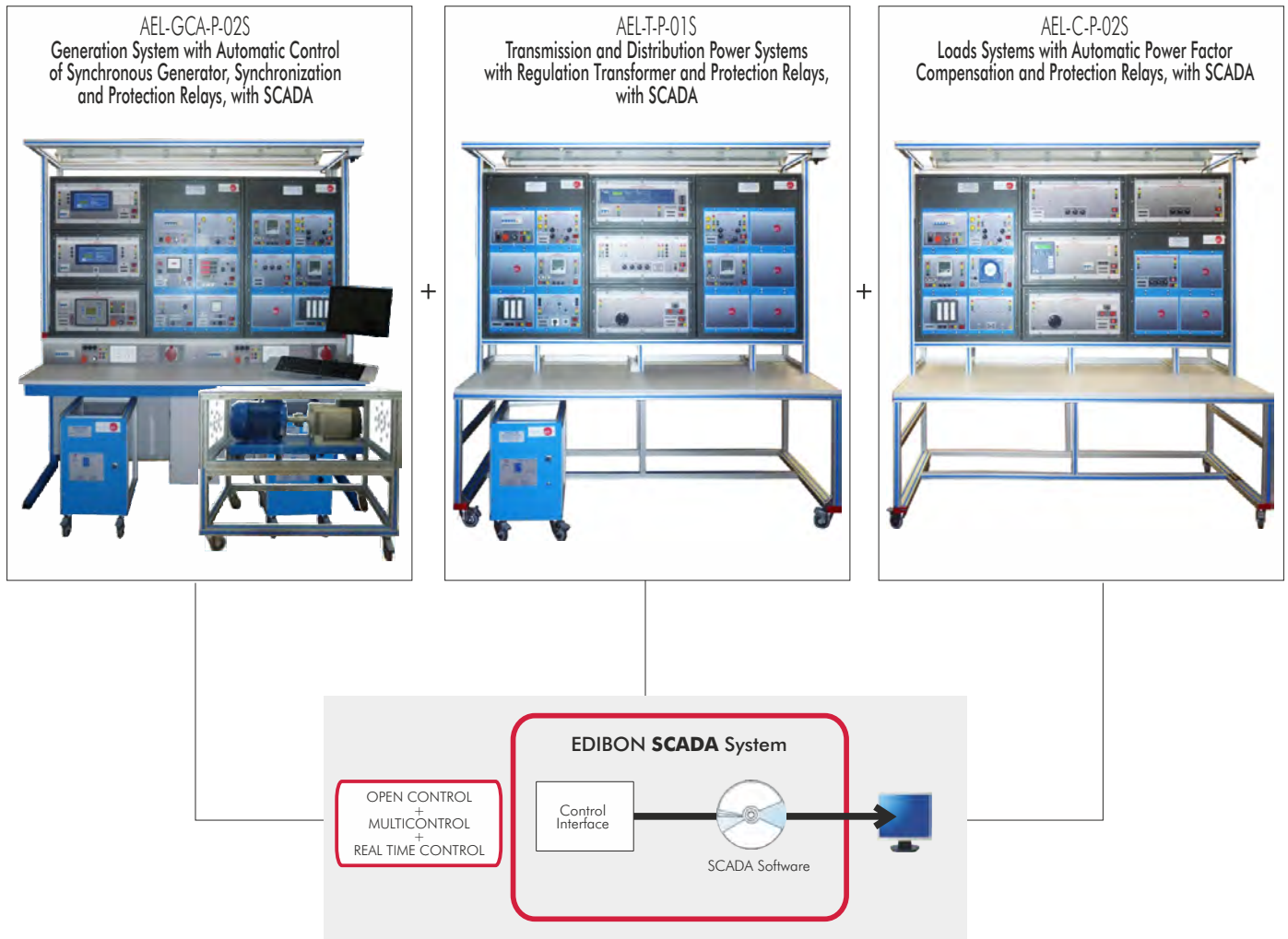

This simulator consists of:

- AEL-GCA-P-02S. **Generation System with Automatic Control of Synchronous Generator, Synchronization and Protection Relays, with SCADA.**
- AEL-T-P-01S. **Transmission and Distribution Power Systems with Regulation Transformer and Protection Relays, with SCADA.**
- AEL-C-P-02S. **Loads Systems with Automatic Power Factor Compensation and Protection Relays, with SCADA.**

SCADA (Supervision, Control and Data Acquisition).

Workbenches and PC.

EXAMPLE

AEL-MPSS-01

INTRODUCTION

Due to electricity can not be stored in large quantities and economically not profitable, so that at each instant must be generated that is consumed. The demanded electric power varies from day to day, so that the generation should follow the same temporal variation, keeping the nominal value of the system frequency, 50 Hz, and other conditions that define the normal operating state of the power system, all with the economic objective of lower cost of production.

For this purpose, the basic objective of the systems of regulation and control of generators installed in power plants generation is to ensure that the demanded power meets continuously, maintaining continuity of supply and the operating parameters of the system within limits. This function is performed automatically from the generators and control centers through automatic voltage regulation (AVR) and, above all, through automatic generation control (AGC).

The AEL-MPSS-01 simulator has been developed to demonstrate how Smart Grids operate within the large power systems:

- How electricity is generated?
- How electricity is transported?
- What happens when there is a change in the energy demand?
- What protection systems are used in generation, transmission, distribution and consumption systems?
- What happens when there is a fault anywhere in the power system? What is the proper configuration of the protection relays so that there is selectivity in the power system?
- How is carried out the regulation of the turbine and synchronous generator?

These and many other questions answers the Modular Smart Grid Power Systems Simulator, with automatic control generation, transmission line, loads and protection relays, with SCADA.

GENERAL DESCRIPTION

The AEL-MPSS-01 has been developed to study in depth the Smart Grid in Generation, Transmission/Distribution and Loads areas.

To facilitate the study of all characteristics issues, and many more, the AEL-MPSS-01 simulator is divided in three applications. Each application has been developed to study in depth a different area of Smart Grids Power Systems:

- AEL-GCA-P-02S. **Generation System with Automatic Control of Synchronous Generator, Synchronization and Protection Relays, with SCADA.**
- AEL-T-P-01S. **Transmission and Distribution Power Systems with Regulation Transformer and Protection Relays, with SCADA.**
- AEL-C-P-02S. **Loads Systems with Automatic Power Factor Compensation and Protection Relays, with SCADA.**

The AEL-MPSS-01 is one of the most comprehensive and advanced modular smart grid power systems simulator for the following reasons:

- The AEL-MPSS-01 integrates the most important Smart Grid technology in all elements that form the power system.
- In a single system we can study the operation of an entire power system, from energy is generated until it reaches the final consumer.
- The AEL-MPSS-01 is provided with 5 latest generation protection relays (renowned manufacturer Schweitzer Engineering Laboratories SEL) used in real electrical substations that give to AEL-MPSS-01 a great authenticity.
- The AEL-MPSS-01 incorporates protection relays as the overcurrent protection relay, the differential protection relay for generators and transformers, long distance protection relay and the protection relay for feeders, which make the system AEL-MPSS-01 a forefront unit in the field of Smart Grids.
- The AEL-MPSS-01 incorporates a sophisticated system of control and regulation of the turbine and synchronous generator that will allow the student to know how carried out the control and regulation in large groups of power generation:
 - Manual/automatic control and regulation of the generator voltage (Automatic Voltage Regulator).
 - Manual/automatic control and regulation of the generator frequency (turbine control).
 - Manual/automatic control and regulation of the power factor of the generator.
- The AEL-MPSS-01 incorporates an automatic reactive power compensation controller that acts autonomously according to the power factor of the load.
- The SCADA System (Supervision, Control and Data Acquisition) whose description can be read below.

Note: AEL-MPSS-01 includes the workbenches and PC.

SCADA System description

The most innovative of the Modular Smart Grid Power Systems Simulator is that it includes SCADA (Supervision, Control and Data Acquisition System) that shows the same behaviour of actual SCADA systems used in the actual power systems. The SCADA Software allows students to take full remote control of the power system and perform all sorts of maneuvers from a synoptic that represents the national power grid. This software allows, among other options, the following:

- Opening and closing actual logic of disconnect switches and circuit breakers.
- Manual and automatic control of the synchronous generator excitation.
- Manual and automatic control of the synchronous generator frequency.
- Manual and automatic power factor control of the synchronous generator.
- Manual and Automatic synchronization control of the synchronous generator with the mains.
- Faults injection in different parts of the system.
- Change in the energy demand of the system with automatic response of the turbine-generator group.
- Real time monitoring the status of disconnectors and circuit breakers.
- Real time monitoring system alarms when the electrical faults are injected.
- Measurement of active, reactive and apparent power at different points of the system.
- Measurement of voltage, current and power factor at different points of the system.

Continue...

AEL-MPSS-01

The SCADA System (Supervision, Control and Data Acquisition) allows the user to understand, in a clear and simple way, how is the management and control of generation, transmission/distribution and loads power systems.

Here are some screenshots of the SCADA Software shown:

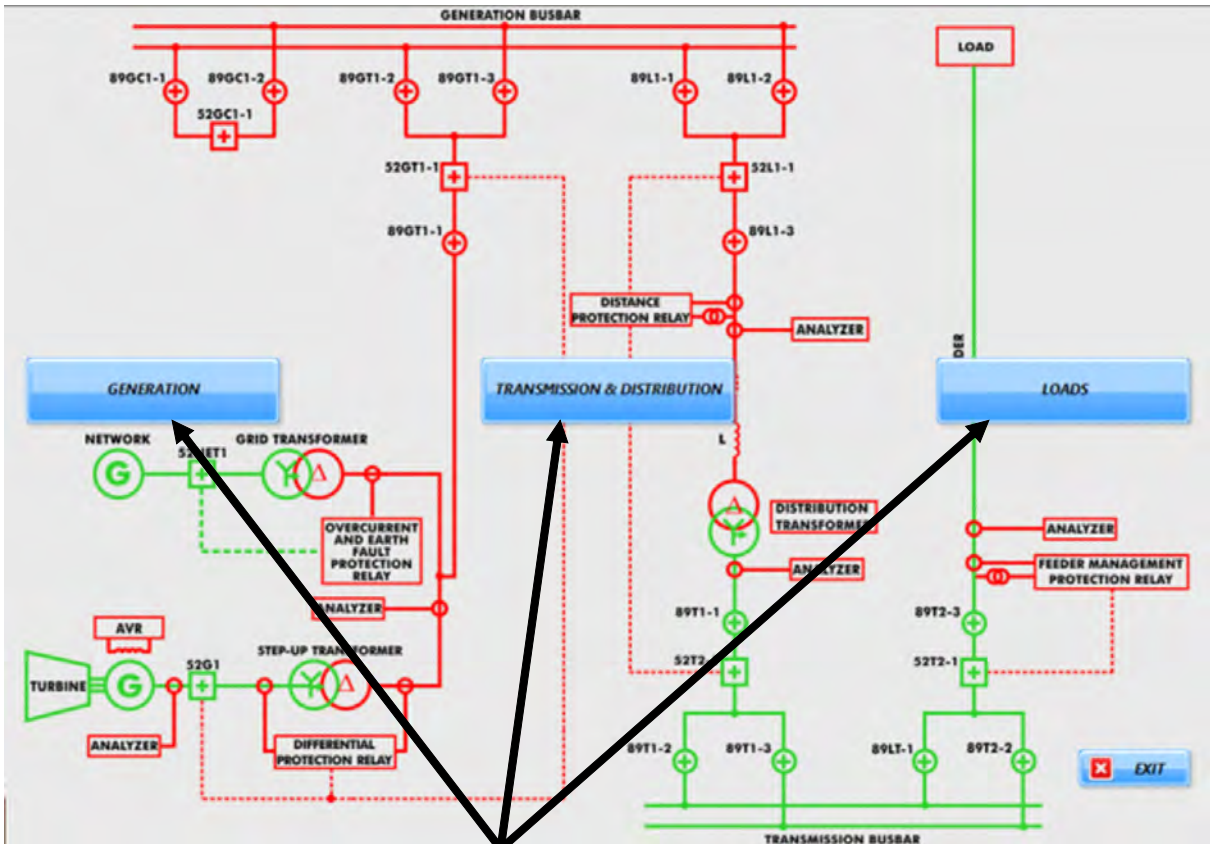

General scheme of the power grid that allows us to control the "generation", "transmission/distribution" and "loads".

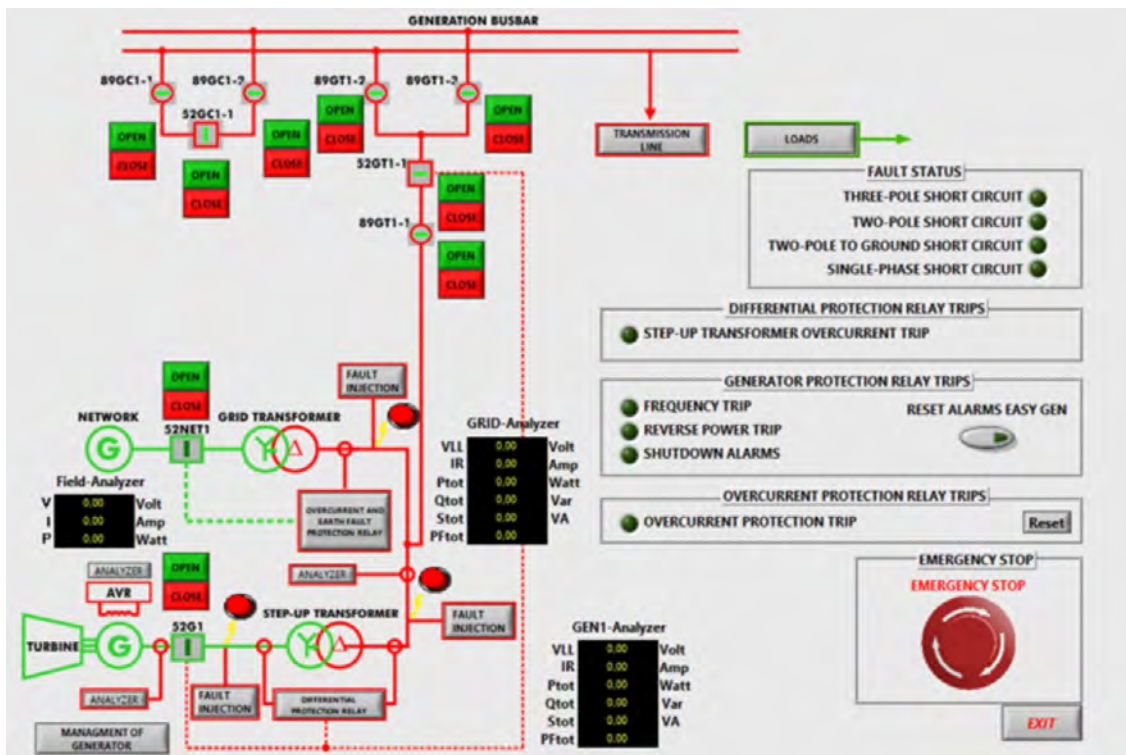

By "clicking" on generation, the most important functions are deployed to control the power flows of our substation power generation: opening and closing logic control of disconnect switches and circuit breakers, measurements of the electrical parameters of the generator and the network, possibilities of faults injections in many points of the generation system, supervision of electrical faults, emergency stop of the generator, etc.

Continue...

EXAMPLE

AEL-MPSS-01

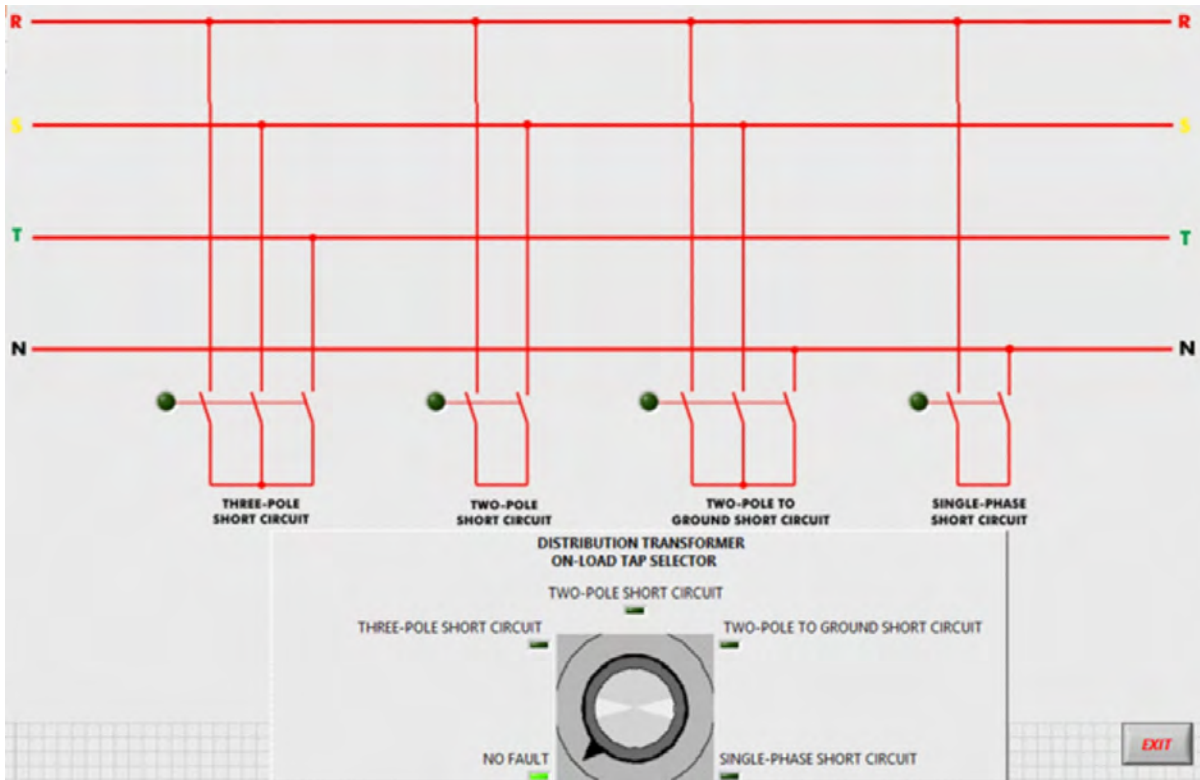

Screen for preselecting electrical faults: fault preselecting of three-phase, two-phase and single-phase with or without fault resistor.

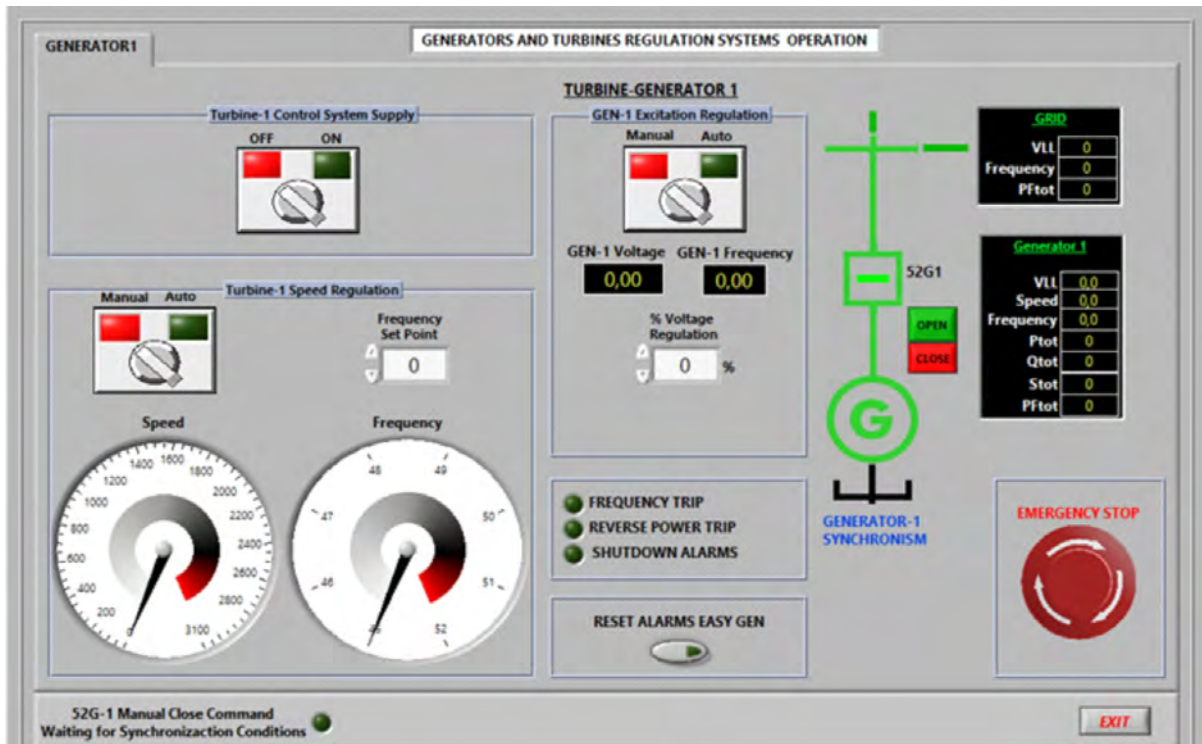

Display control of the turbine and the synchronous generator. This menu offers multiple possibilities for control and regulation of the group.

- Precise and manual control of turbine frequency.
- Automatic control of the turbine frequency.
- Precise manual control of the excitation of the synchronous generator.
- Automatic control of synchronous generator excitation.
- Manual synchronization of synchronous generator with the mains.
- Automatic synchronization of synchronous generator with electrical network.
- Island operation mode.
- Alarm monitoring of frequency and reverse power.
- Emergency stop.
- Supervision of the electrical parameters of the generator and the power grid.
- Monitoring the speed of the turbine.

Continue...

AEL-MPSS-01

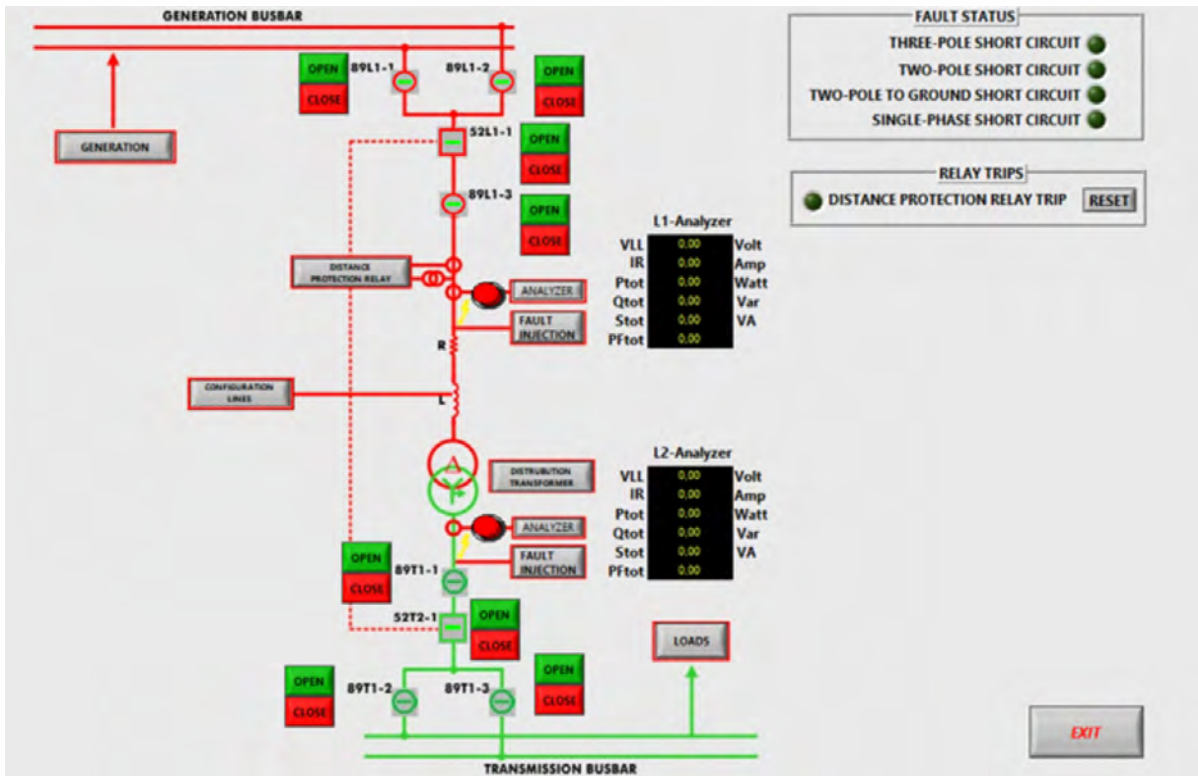

By "clicking" on transmission/distribution, the most important functions are deployed to control the elements of our receiving and emitter substation:

- Setting of resistance, inductance and capacitance parameters of the transmission line.
- Opening and closing logic control of disconnect switches and circuit breakers.
- Measurements of the electrical parameters upstream and downstream of the transmission line for the study of energy losses in transporting.
- Faults injection in many points of the transmission system.
- Supervision of electrical faults.
- Voltage adjusting with the distribution transformer with the voltage regulator TAP.

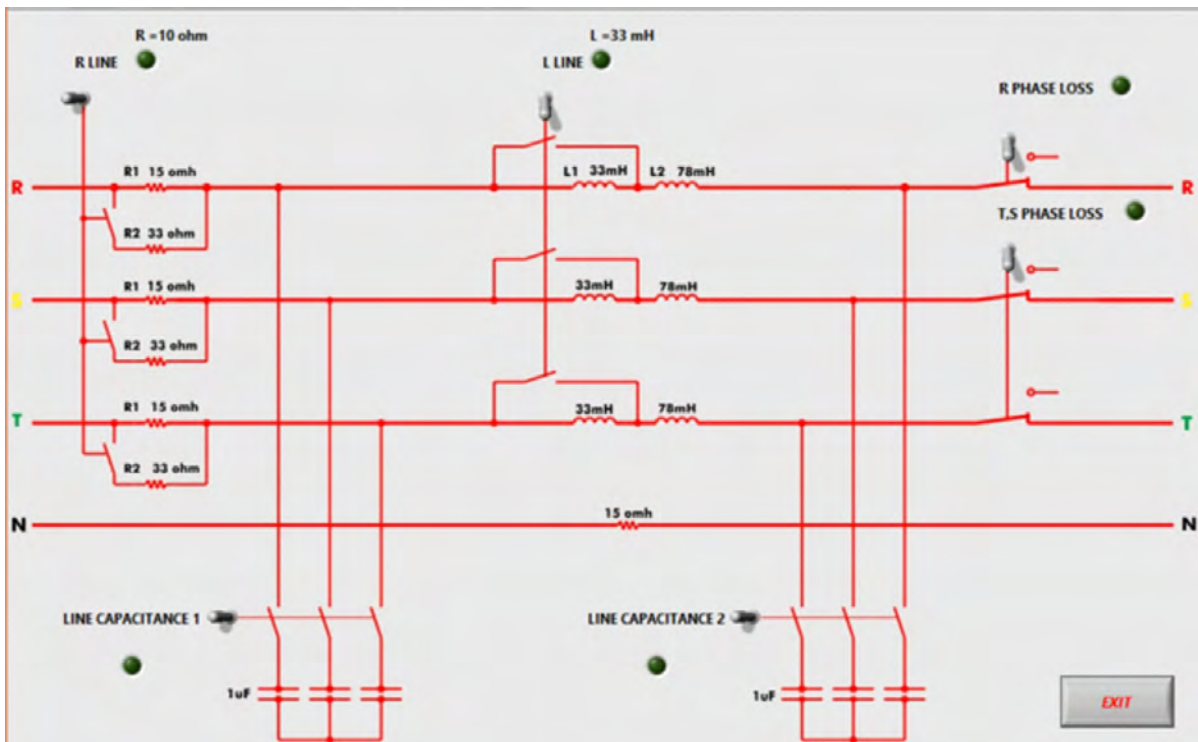

Setup menu of the electrical parameters of the transmission line.

Continue...

AEL-MPSS-01

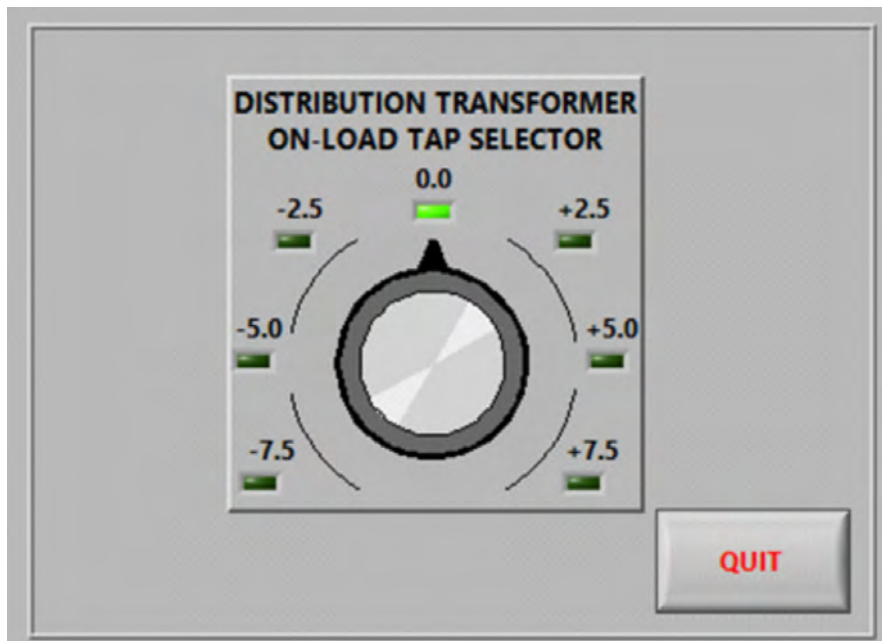

Load voltage regulation menu.

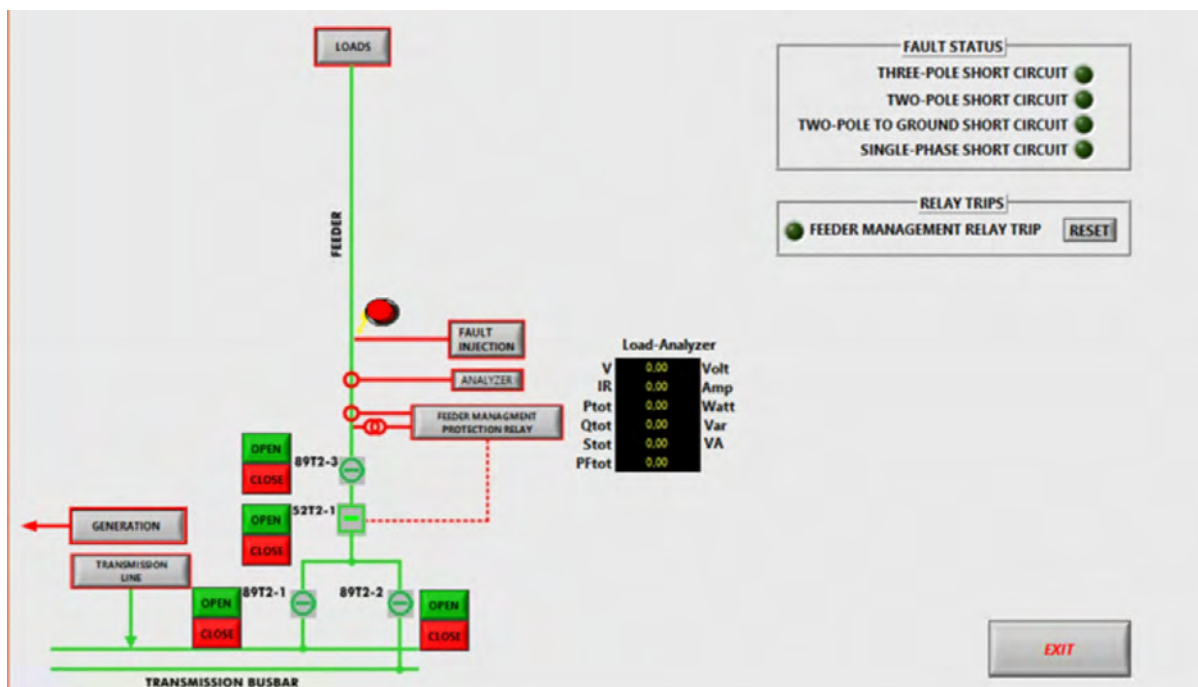

By "clicking" on loads, the most important functions are deployed to control the elements of our distribution substation:

- Setting the resistance, inductance and capacitance parameters loads.
- Opening and closing control logic of disconnect switches and circuit breakers.
- Measuring of the demanded electrical parameters.
- Faults injection in many points of the loads system.
- Supervision of electrical faults.

EXAMPLE

AEL-MPSS-01

SPECIFICATIONS

The AEL-MPSS-01 simulator includes three applications. Each application has been developed to study in depth a different area of Smart Grids Power Systems:

- AEL-GCA-P-02S. **Generation System with Automatic Control of Synchronous Generator, Synchronization and Protection Relays, with SCADA.**
- AEL-T-P-01S. **Transmission and Distribution Power Systems with Regulation Transformer and Protection Relays, with SCADA.**
- AEL-C-P-02S. **Loads Systems with Automatic Power Factor Compensation and Protection Relays, with SCADA.**

AEL-GCA-P-02S. Generation System with Automatic Control of Synchronous Generator, Synchronization and Protection Relays, with SCADA.



GENERATION

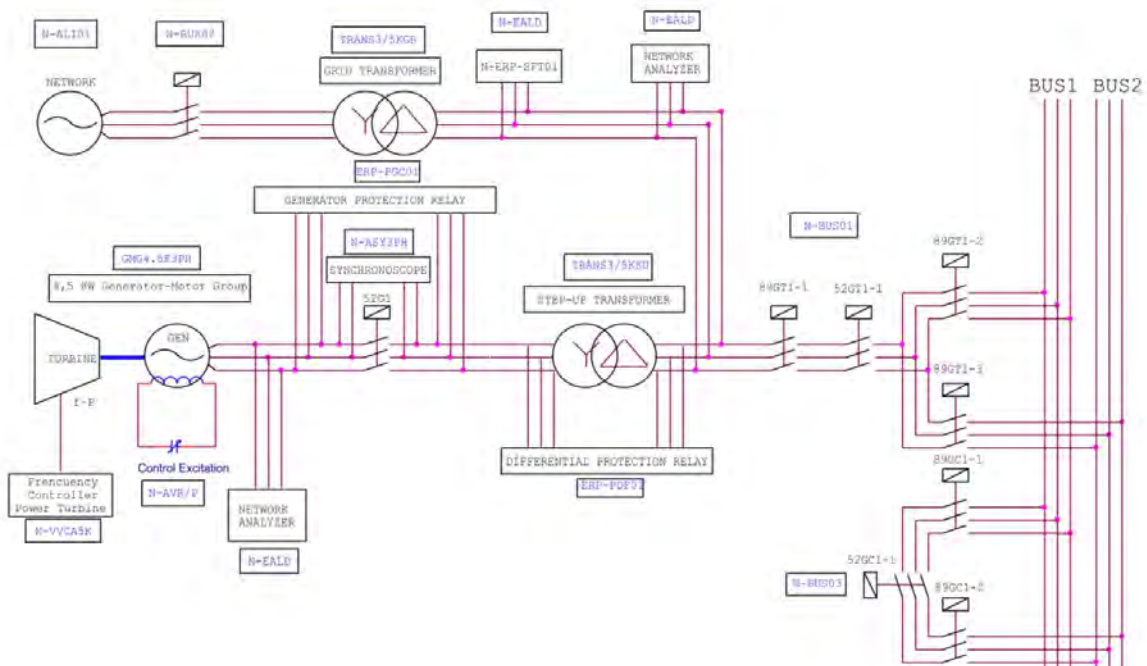

Continue...

EXAMPLE

AEL-MPSS-01

Specifications (continuation)

The AEL-GCA-P-02S is a modular application developed to study the actual generation power systems with Smart Grid Technology.

The Generation System with Automatic Control of the Synchronous Generator, Synchronization and Protection Relays, with SCADA (AEL-GCA-P-02S), consists of a series of modules that allows us to simulate the most important operations of control, regulation and supervision performed in a Generation Power System, that is to say, from the electrical energy is generated and raised it with the step-up transformer, until the injection of this energy to the grid.

To perform these operations, in the AEL-GCA-P-02S application are included certain devices that make our application a true Smart Grid:

- Modules to control and regulate the turbine-generator group:
 - Manual/Automatic control and regulation of the generator voltage (Automatic Voltage Regulator).
 - Manual/Automatic control and regulation of the generator frequency (turbine control).
 - Manual/Automatic control and regulation of the generator power factor.
- The overcurrent protection relay, the differential protection relay for generators and transformers, and management relay of generators.
- It includes a sophisticated fault injection system in order to analyze the transients evolution and to observe the request of the protection relays used on this application.
- Network Analyzers that show us in real time the electrical parameters of the nodes of the system.
- Synchronizing devices for the synchronization maneuvers of synchronous generator and the grid that show us the phases sequence, the difference of voltage and frequency between the generator and the grid.

The AEL-GCA-P-02S includes:

Modules:

- N-ALI01. **Industrial Main Power Supply.**
- N-BUS01. **Generation Busbar.**
- N-BUS02. **Coupling Busbar.**
- N-BUS03. **Grid Busbar.**
- N-EALD. **Network Analyzer Unit with Computer Data Acquisition.** (2 units)
- N-EALDC/G. **DC Generator Analyzer.**
- N-AVR/P. **Automatic Voltage Regulator.**
- N-WCA5K. **5KW Motor Speed Controller.**
- N-ASY3PH. **Three-Phase Automatic Synchronoscope.**
- N-PLC01. **PLC01 Control Module.**
- N-ERP-SFT01. **Overcurrent Protection Relay Module.**
- N-ERP-PDF01. **Differential Protection Relay Module.**
- N-ERP-PGC01. **Generator Protection and Control Relay Module.**
- N-ERP-MF01. **Digital Fault Simulator Module.**

Transformers:

- TRANS3/5KGR. **5KW Three-Phase Grid Transformer.**
- TRANS3/5KSU. **5KW Three-Phase Step-Up Transformer.**

Generators:

- GMG4.5K3PH. **4.5KW Generator-Motor Group.**

SCADA (Supervision, Control and Data Acquisition).

Technical Data:

Modules:

- N-ALI01. **Industrial Main Power Supply.**
 - Industrial three-phase power supply.
 - Three-Phase power supply: 400 VAC.
 - Emergency stop push-button.
 - Safety key.
 - Three-phase terminal connections.
 - Single-phase terminal connections.
 - 7 pin connector to supply the module.
 - 30mA Three-phase differential protection.
- N-BUS01. **Generation Busbar.**
 - Double generation busbar Module.
 - Local/Remote control switch.
 - Slide commutators of disconnectors and circuit breaker.
 - Indicator status lamps. ON-OFF switch.
 - Signal connector SUB-D 62 pins.

Continue...

AEL-MPSS-01

Specifications (continuation)

•N-BUS02. **Coupling Busbar.**

Double coupling busbar Module.
Local/Remote control switch.
Slide commutators of disconnectors and circuit breaker.
Indicator status lamps. ON-OFF switch.
Signal connector SUB-D 62 pins.

•N-BUS03. **Grid Busbar.**

Grid busbar module.
Local/Remote control switch.
Slide commutators of disconnectors and circuit breaker.
Indicator status lamps. ON-OFF switch.
Signal connector SUB-D 62 pins.

•N-EALD. **Network Analyzer Unit with Computer Data Acquisition.** (2 units)

Power Switch.
Input terminals: Three-Phase measurement input terminals with neutral, 400VAC.
Output terminals: Three-Phase measurement output terminals with neutral, 400VAC.
Communication port Rs485.
Supply terminals: Nominal Voltage: 230VAC.
Fuses: Line fuses 3x10A.
Digital Outputs: Three digital outputs for pulses or alarms, or for combining either.
Network Analyzer:
It allows to measure the voltage, currents, active power, reactive power, frequencies, energies per phases, armonics, etc.
Navigation Joystick: It allows us to navigate with different analyzer parameters.
Preselector:
This element allows us to preselect different standard measurements:
Position 1: Measurement of phase voltage.
Position 2: Measurement of line currents.
Position 3: Measurement of line powers.

•N-EALDC/G. **DC Generatoy Analyzer.**

DC Analyzer Module.
Rated voltage range: 0-100 Vdc.
Rated current range: 0-10 A.
Communication port RS-485.
2 Power connectors with 7 pin.
ON-OFF Switch.
Terminal connections.
Fuse 10 A.

•N-AVR/P. **Automatic Voltage Regulator.**

Generator voltage regulator module.
Local/Remote control switch.
Manual/Automatic control switch of generator excitation in local mode.
Potentiometer for manual control of the current excitation.
ON-OFF Switch.
Terminal connections.
Signal connector SUB-D 62 pins.

•N-WCA5K. **5KW Motor Speed Controller.**

5KW Motor Speed Controller Module.
Three-Phase Power Supply: 400VAC + N.
Nominal Power: 5KW.
Potentiometer speed control motor.
Start/Stop control switch.
Local/Remote control switch.
Signal connector SUB-D 62 pins.
ON-OFF Switch.
Connection terminals.

Continue...

EXAMPLE

AEL-MPSS-01

Specifications (continuation)

•N-ASY3PH. **Three-Phase Automatic Synchronoscope.**

Three-Phase digital and programmable synchronoscope.

Display:

Mains voltage display.

Generator voltage display.

Phases difference of mains and generator display.

Synchronization manual push-button.

Disable push-button sync.

Local/remote control switch.

Indicator lamp of synchronizing contactor.

ON-OFF switch.

Terminal connections.

Safety fuses.

Signal connector SUB-D 62 pins.

•N-PLC01. **PLC01 Control Module.**

PLC Siemens S7-300.

Signal connector SUB-D 62 pins.

ON-OFF Switch.

2 x Fuses 2A.

•N-ERP-SFT01. **Overcurrent Protection Relay.**

Overcurrent protection relay module.

Power supply: 230 VAC.

TRIP indicator lamps.

Overcurrent and Earth fault protection.

Communications connector DB9 RS-232.

Signals connector SUB-D 62 pin.

ON-OFF Switch.

Terminal connections.

Characteristics:

- Phase, ground and negative sequence overcurrent protection.
- Time-Overcurrent curves of US and IEC.
- Reclosing relays of multiple trips with sequence coordination.
- SELOGIC® enhanced control equations to develop traditional or advanced schemes.
- Logic of local / remote control to change the schemes, operating circuit breakers, etc.
- Recorder of the sequence of events (SER) and reports of events stored in nonvolatile memory.
- Supports ASCII, SEL LMD, and Modbus RTU protocols.

•N-ERP-PDF01. **Differential Protection Relay Module.**

Differential protection relay module.

Power supply: 230 VAC.

TRIP lamp indicator.

Differential protection.

Communications connector DB9 RS-232.

Signals connector SUB-D 62 pins.

ON-OFF switch.

Terminal connectors.

Characteristics:

This module protects transformers with two terminals, generators, reactances and other power devices using a combination of differential, instantaneous and overcurrent elements. Differential security scheme is achieved through the following actions:

- Dual-slope restricting percentage.
- Lock second and fourth harmonic.
- Lock the fifth harmonic for transformer overexcitation.
- Compensation of the CT connection and the transformers.

Continue...

EXAMPLE

AEL-MPSS-01

Specifications (continuation)

•N-ERP-PGC01 . **Generator Relay Protection Module.**

Generator protection relay and control module.

Power supply: 230 VAC.

"island grid/parallel grid" control switch.

"local/remote" control switch.

Manual control switches of the generator relay module:

1. SW1 Emergency Stop.
2. SW2 Automatic start of generator-motor group.
3. SW3 reset alarms push-button.
4. SW4 enable frequency control of the generator.
5. SW5 manual permission to close the 52G1 synchronization circuit breaker.

Status indicator lamps. Status indicator alarms lamps. Safety key for synchronization. Emergency stop push-button.

Signal connector SUB-D 62 pins.

ON-OFF switch.

Terminal connections.

Some characteristic of the generator protection relay module N-ERP-PGC01 :

- The N-ERP-PGC01 allows to operate with until 16 synchronous generators in island grid mode with reactive and active load share, automatic start/stop of the generators in function of the demanded energy.
- The N-ERP-PGC01 allows parallel operations of one generator with the mains.
- The N-ERP-PGC01 allows different control modes of circuit breakers as opening, closing and synchronization.
- The N-ERP-PGC01 has analog outputs to control the voltage and frequency regulators of the market.
- Three-phase measurement of the mains and generator voltage.
- Three-phase measurement of the current and power of the generator.
- Single-phase measurement of the mains.

Protections:

- Generator: max/mín-voltage (59/27), max/min-frequency (81 O/U), voltage asymmetry, dead bus detection, overload (32), unbalance load (46), reverse power/reduce (32R/F), overcurrent time define curve (50/51), inverse time overcurrent (IEC255), fault ground (50N/51N), phases, breakers fault.
- Motor: over/sub speed (12).
- Mains: max/min-voltage (59/27), max/min-frequency (81 O/U), vector surge.

•N-ERP-MF01 . **Digital Faults Simulator Module.**

Faults injection module.

Preselector of kind of fault:

Three-Phase short circuit.

Two-phase short circuit.

Two-phase to ground short circuit.

Single-phase short circuit.

Local/Remote control switch.

ON-OFF switch.

Terminal connections.

Signals connector SUB-D 62 pins.

Transformers:

• TRANS3/5KGR. **5KW Three-Phase Grid Transformer.**

5KVA Three-Phase Grid transformer.

Rated Power: 5KVA.

Rated Primary Voltage: 400VAC Star.

Rated Secondary Voltage: 400VAC Delta.

•TRANS3/5KSU. **5KW Three-Phase Step-up Transformer.**

5KVA Step-Up transformer.

Rated Power: 5KVA.

Rated Primary Voltage: 400VAC Star.

Rated Secondary Voltage: 400VAC Delta.

Generators:

•GMG4.5K3PH. **4.5KW Generator-Motor Group.**

Generator-Motor Group mounted in aluminum structure with wheels.

Rated generator power: 4,5 KVA.

I rated stator: 6.5A.

I rated excitation: 4A.

RPM: 3000 rpm.

Rated motor power: 5 KVA.

I rated: 7.2A.

RPM: 3000 rpm.

SCADA (Supervision, Control and Data Acquisition).

Continue...

EXAMPLE

AEL-MPSS-01

Specifications (continuation)

EXERCISES AND PRACTICAL POSSIBILITIES WITH AEL-GCA-P-02S

With local control mode:

- 1.- Studying of generation power systems with double busbar configuration.
- 2.- Studying of opening and closing maneuvers of isolator switches and circuit breaker in double busbar systems.
- 3.- Analysis of the measurements of the power flows of the synchronous generator.
- 4.- Analysis of the active and reactive power of the generator.
- 5.- Manual synchronization maneuvers of synchronous generator with the mains.
- 6.- Automatic synchronization maneuvers of synchronous generator with the mains.
- 7.- Studying of the synchronous generator in island operation mode.
- 8.- Studying of the Micro-Grids.
- 9.- Studying of the synchronous generator in grid parallel operation mode.
- 10.- Studying of excitation/voltage regulation of synchronous generator in island mode.
- 11.- Studying of turbine regulation (frequency control) in island mode.
- 12.- Studying of excitation/voltage regulation of synchronous generator in parallel grid operation mode.
- 13.- Studying of turbine regulation (frequency control) in parallel grid operation mode.
- 14.- Studying of the power factor regulation of synchronous generator in parallel grid operation mode.
- 15.- Studying of short circuits in different points of generation power system:
 - a. Symmetric short circuits: three-phase short circuits with and without contact impedance.
 - b. Asymmetric faults:
 - i. Two-phase short circuit with and without contact impedance.
 - ii. Two-phase to ground shortcircuit with and without contact impedance.
 - iii. Single-phase short circuit with and without contact impedance.
- 16.- Studying of synchronous generator protection and control relay.
- 17.- Studying of differential protection relay.
- 18.- Studying of overcurrent protection relay.
- 22.- Analysis with SCADA software of active and reactive power of synchronous generator.
- 23.- Remotely control of manual synchronization of synchronous generator with the mains.
- 24.- Remotely control of automatic synchronization of synchronous generator with the mains.
- 25.- Remotely control of synchronous generator in island grid operation mode.
- 26.- Studying of Micro-Grids.
- 27.- Remotely control of synchronous generator in parallel grid operation mode.
- 28.- Remotely control of excitation/voltage regulation of synchronous generator in island mode.
- 29.- Remotely control of the turbine regulation (frequency control) in island operation mode.
- 30.- Remotely control of excitation/voltage regulation of the synchronous generator in parallel grid operation mode.
- 32.- Remotely control of turbine regulation (frequency control) in parallel grid operation mode.
- 33.- Remotely control of power factor regulation of synchronous generator in parallel grid operation mode.
- 34.- Remotely control of short circuits in different points of the generation power system:
 - a. Symmetric short circuits: three-phase short circuits with and without contact impedance.
 - b. Asymmetric faults:
 - i. Two-phase short circuit with and without contact impedance.
 - ii. Two-phase to ground shortcircuit with and without contact impedance.
 - iii. Single-phase short circuit with and without contact impedance.
- 35.- Supervision of TRIPS from the SCADA software (protection relays shooting) in the power system.
- 36.- Remotely control of the synchronous generator protection and control relay.
- 37.- Remotely control of the differential protection relay.
- 38.- Remotely control of the overcurrent protection relay.
- 39.- Supervision of the electrical parameters of the generation system with the SCADA software.

Remote control mode (with SCADA System):

- 19.- Remotely control of generation power systems with double busbar.
- 20.- Remotely control of opening and closing maneuvers of isolator switches and circuit breaker in double busbar systems.
- 21.- Analysis with the SCADA software of synchronous generator power flows.

AEL-MPSS-01

Specifications (continuation)

AEL-T-P-01S. Transmission and Distribution Power Systems with Regulation Transformer and Protection Relays, with SCADA.



TRANSMISSION/DISTRIBUTION

BUS1 BUS2

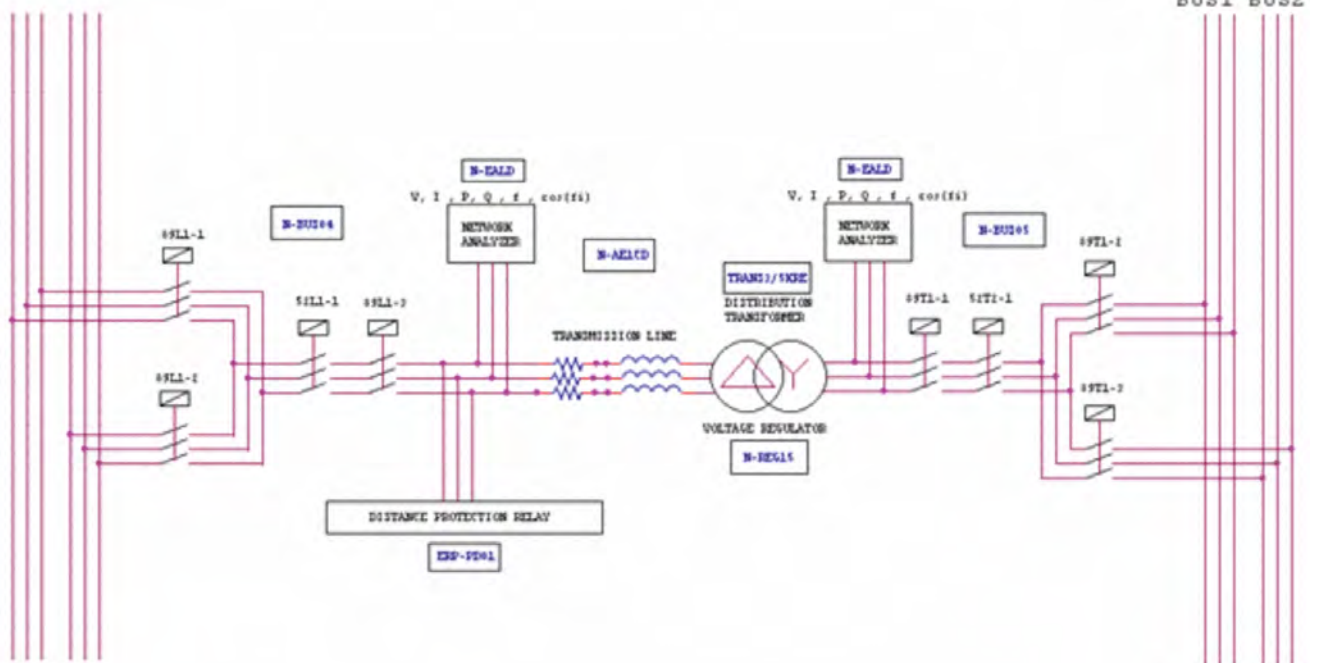

Continue...

EXAMPLE

AEL-MPSS-01

Specifications (continuation)

The Transmission and Distribution Power Systems with Regulation Transformer and Protection Relays, with SCADA (AEL-T-P-01S) is a modular application with Smart Grid technology developed to study the Transport and Distribution power systems.

This application allows the student to acquire the most important knowledge about how the electrical energy is transported, why it is rised until certain voltage levels, what is the function of the transformers with voltage regulator, etc. Besides, the student will know how are performed the basic maneuvers in double busbar systems, what is the correct sequence of actuation between isolator switches and circuit breaker and many other questions.

The AEL-T-P-01S application consists of a series of modules that allow us simulate the most important operations of control, regulation and supervision performed in emitter and receiver substations joined with an aerial transmission line.

In order to put in practice all these knowledge, in the AEL-T-P-01S application are included certain devices that make our application a true Smart Grid:

- It includes a distance protection relay. This relay monitors, in real time, the impedance parameters of the transmission line.
- It includes a sophisticated faults injection module to analyze the evolution of transients and observe the request of the protection relays used in the application.
- It includes network analyzers that show us in real time the electrical parameters in the transmission line to study the energy losses, droop voltages, line currents, etc.
- It includes a voltage regulator TAP in the distribution transformer to compensate the droop voltage of the transmission line.

The AEL-T-P-01S includes:

Modules:

- N-ALI01. **Industrial Main Power Supply.**
- N-BUS04. **Emitter Transport Busbar.**
- N-BUS05. **Receptor Transport Busbar.**
- N-EALD. **Network Analyzer Unit with Computer Data Acquisition.** (2 units)
- N-PLC02. **PLC02 Control Module.**
- N-REG15. **Tap Module Regulator.**
- N-AE1CD. **Transmission Lines Simulator Digital Unit.**
- N-ERP-PD01. **Distance Protection Relay Module.**
- N-ERP-MF01. **Digital Fault Simulator Module.**

Transformers:

- TRANS3/5KR. **5KW Step-Down Transformer with Voltage Regulator.**

SCADA (Supervision, Control and Data Acquisition).

Technical Data:

Modules:

- N-ALI01. **Industrial Main Power Supply.**
 - Industrial three-phase power supply.
 - Three-Phase power supply: 400 VAC.
 - Emergency stop push-button.
 - Safety key.
 - Three-phase terminal connections.
 - Single-phase terminal connections.
 - 7 pin connector to supply the module.
 - 30mA Three-phase differential protection.

- N-BUS04. **Emitter Transport Busbar.**
 - Emitter transport busbar module.
 - Local/remote switch.
 - Slide commutators of disconnectors and circuit breaker.
 - Status indicator lamps. ON-OFF switch.
 - Communication connector.
 - Power supply: 230 VAC.

- N-BUS05. **Receptor Transport Busbar.**
 - Double distribution busbar module.
 - Local/Remote control switch.
 - Slide commutators of of disconnectors and circuit breaker.
 - Status indicator lamps. ON-OFF switch.
 - Communications connector SUB-D 62 pin.

- N-EALD. **Network Analyzer Unit with Computer Data Acquisition.** (2 units)
 - Power Switch.
 - Input terminals: Three-Phase measurement input terminals with neutral, 400VAC.
 - Output terminals: Three-Phase measurement output terminals with neutral, 400VAC.
 - Communication port Rs485.
 - Supply terminals: Nominal Voltage: 230VAC.

EXAMPLE

AEL-MPSS-01

Specifications (continuation)

Fuses: Line fuses 3x10A.

Digital Outputs: Three digital outputs for pulses or alarms, or for combining either.

Network Analyzer:

It allows to measure the voltage, currents, active power, reactive power, frequencies, energies per phases, harmonics, etc.

Navigation Joystick: It allows us to navigate with different analyzer parameters.

Preselector:

This element allows us to preselect different standard measurements:

Position 1: Measurement of phase voltage.

Position 2: Measurement of line currents.

Position 3: Measurement of line powers.

•N-PLC02. **PLC02 Control Module.**

PLC Siemens S7-300.

Signal connector SUB-D 62 pins.

ON-OFF Switch.

2 x Fuses 2A.

•N-REG15. **Tap Module Regulator.**

TAP voltage regulator module.

Single-Phase power supply: 230VAC.

Voltage TAP selector:

+7,5%; +5%; +2,5%; 0%; -7,5%; -5%; -2,5%.

Indicator lamps regulation percentage.

Local/remote control switch.

OFF-ON Commutator.

ON-OFF switch.

Signal connector SUB-D 62 pins.

•N-AE1CD. **Transmission Lines Simulator Digital Unit.**

Transmission lines simulation digital unit.

Local/remote switch.

Switches to preselect a line resistance.

Switches to preselect a line inductance.

Switches to simulate R phase lost.

Switches to simulate S and T phase lost.

Status indicator lamp. ON-OFF switch.

Voltage Lines (400 VAC).

•N-ERP-PD01. **Distance Protection Relay Module.**

It is used to enable investigations into protection and monitoring of overhead transmission lines and underground cables. It enables a wide range of test and investigations and it demonstrates the latest relay technology.

Modern industrial application distance protection relay presented in an educational and teaching format.

The connections are via safety sockets.

The main functions:

Two zones of Phase Mho Distance Protection Element (21P).

Two zones of Ground Mho Distance Protection Element (21G).

Directional Phase Overcurrent Protection Element (67P).

Directional Ground Overcurrent Protection Element (67G).

Phase Overcurrent Protection Element (50P).

Ground Overcurrent Protection Element (50G).

Phase Time-Overcurrent Protection Element (51P).

Ground Time-Overcurrent Protection Element (51G).

Event Reports.

Breaker Wear Monitor.

Fault Locator.

Local Display.

Synchronphasors.

Load Encroachment.

Metering and Monitoring Functions.

Creating fault and disturbance records.

Blocking of any one protection element.

The connection to the experimental circuit is via current transformers with ratio to suit the inputs of the relay.

It allows an effective demonstration of the effect of current and voltage transformer ratio, connection and rating on protective relays.

Accuracy: +- 10%. Current: 5 A (A. C.). Frequency: 50 or 60 Hz.

Operating time: typically 10 ms to 25 ms.

Continue...

EXAMPLE

AEL-MPSS-01

Specifications (continuation)

• N-ERP-MF01. **Digital Fault Simulator Module.**

- Faults injection module.
- Preselector of kind of fault:
 - Three-Phase short circuit.
 - Two-phase short circuit.
 - Two-phase to ground short circuit.
 - Single-phase short circuit.
- Local/Remote control switch.
- ON-OFF switch.
- Terminal connections.
- Signals connector SUB-D 62 pins.

Transformers:

• TRANS3/5KR. **5KW Step-Down Transformer with Voltage Regulator.**

- Isolating three-phase power transformer.
- Pn: 5KVA. Vp with regulation: 400VAC delta. +7,5%, +5%, +2,5%, 0%, -2,5%, -5%, 7,5%. Vs: 400VAC Star.

SCADA (Supervision, Control and Data Acquisition).

EXERCISES AND PRACTICAL POSSIBILITIES WITH AEL-T-P-01 S

Local control:

- 1.- Opening and closing basic maneuvers of isolator switches and circuit breaker.
 - 2.- Measurements of energy losses in the transmission line.
 - 3.- Droop voltage compensation with the voltage regulator TAP.
 - 4.- Real time measurements of the electrical parameters (voltage, current, frequency, power factor, active power, reactive power, apparent power, active energy, reactive energy, apparent energy, etc.).
 - 5.- Studying of the energy losses of the transmission line.
 - 6.- Studying of the droop voltages in the transmission line in function on the load system.
 - 7.- Automatic configuration of the line parameters.
 - 8.- Automatic selection of the line to line capacitive effect.
 - 9.- Automatic selection of line resistor.
 - 10.- Automatic selection of line inductance.
 - 11.- Simulation of one phase loss.
 - 12.- Simulation of two phase loss.
 - 13.- Studying of short circuits in different points of transmission power system:
 - a. Symmetric short circuits: three-phase short circuits with and without contact impedance.
 - b. Asymmetric faults:
 - i. Two-phase short circuit with and without contact impedance.
 - ii. Two-phase to ground shortcircuit with and without contact impedance.
 - iii. Single-phase short circuit with and without contact impedance.
 - 14.- Recording the evolution of voltage and current phasors during short circuit for further analysis.
 - 15.- Calculation of the electrical parameters of the line to configure the distance protection relay (mho characteristic).
 - 16.- Studying in depth of the distance protection relay.
- Remote control (with SCADA System):
- 17.- Supervision, Control and Data Acquisition of all electrical parameters of the transmission line.
 - 18.- Monitoring of energy losses of transmission lines from the PC.
 - 19.- Remotely control of distribution transformer voltage regulator (TAP). Compensation of droop voltages of the transmission line.
 - 20.- Studying of energy losses of the transmission line.
 - 21.- Remote measurement of droop voltages in the transmission line in function on the system load.
 - 22.- Remote automatic configuration of the transmission line impedance.
 - 23.- Remote automatic selection of the line to line capacitive effect of the transmission line.
 - 24.- Remote automatic selection of the line resistor of the transmission line.
 - 25.- Remote automatic selection of the line inductance of the transmission line.
 - 26.- Remote automatic selection of one line phase loss.
 - 27.- Remote automatic selection of two line phases loss.
 - 28.- Remotely control of short circuits in different points of the transmission power system:
 - a. Symmetric short circuits: three-phase short circuits with and without contact impedance.
 - b. Asymmetric faults:
 - i. Two-phase short circuit with and without contact impedance.
 - ii. Two-phase to ground shortcircuit with and without contact impedance.
 - iii. Single-phase short circuit with and without contact impedance.
 - 29.- Short circuits temporal evolution recording of voltage and currents phasors for further analysis.
 - 30.- Calculation of the electrical parameters of the transmission line for subsequent configuration of the distance relay (mho characteristic).
 - 31.- Studying in depth of the distance protection relay.

Continue...

AEL-MPSS-01

Specifications (continuation)

AEL-C-P-02S. Loads Systems with Automatic Power Factor Compensation and Protection Relays, with SCADA



LOADS

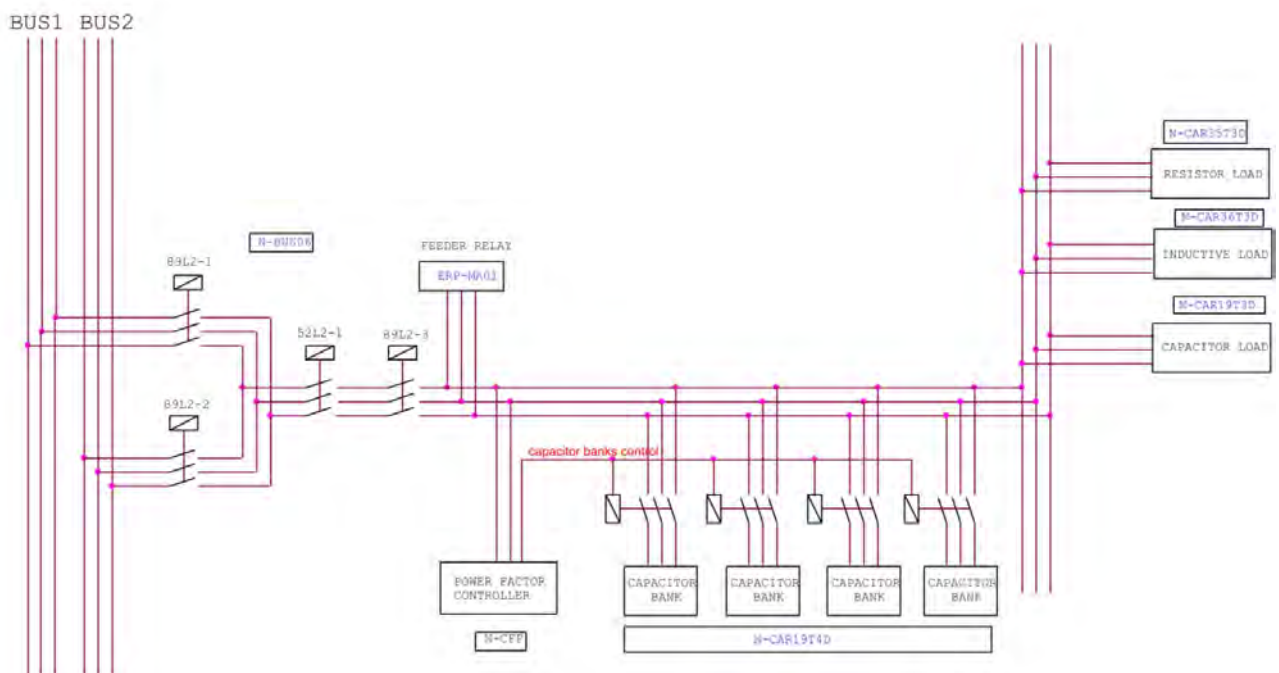

Continue...

EXAMPLE

AEL-MPSS-01

Specifications (continuation)

The AEL-C-P-02S is a modular application developed to study the operation and control of the final loads of the power systems. This application is equipped with the most advanced protection systems used nowadays in substations and distribution lines. Besides, the AEL-C-P-02S has an automatic power factor compensation (SVC type). The AEL-C-P-02S has an overcurrent protection relay used in distribution systems (feeders) with which the student will simulate different short circuits along the load distribution system and subsequently, the student will analyze how the protection relay acts over corresponding circuit breaker. Besides, the AEL-C-P-02S application has an automatic power factor controller with six stages. For the analysis of the automatic response of the power factor controller, we have a group of resistive, inductive and capacitive loads in order to simulate actual process of the energy demand and the power factor compensation.

The AEL-C-P-02S includes:

Modules:

- N-ALI01 . **Industrial Main Power Supply.**
- N-BUS06. **Distribution Busbar.**
- N-EALD. **Network Analyzer Unit with Computer Data Acquisition.**
- N-CFP. **Advanced Power Factor Controller Module.**
- N-PLC03. **PLC03 Control Module.**
- N-CAR19T4D. **Three-Phase Digital Capacitor Banks Module.**
- N-CAR36T3D. **Three-Phase Digital Bank of Commutable Inductances module.**
- N-CAR35T3D. **Three-Phase Digital Bank Resistors Module.**
- N-CAR19T3D. **Three-Phase Digital Bank of Commutable Capacitors Module.**
- N-ERP-MA01 . **Feeder Management Relay Module.**
- N-ERP-MF01 . **Digital Fault Simulator Module.**

SCADA (Supervision, Control and Data Acquisition).

Technical Data:

Modules:

- N-ALI01 . **Industrial Main Power Supply.**
 - Industrial three-phase power supply.
 - Three-Phase power supply: 400 VAC.
 - Emergency stop push-button. Safety key.
 - Three-phase terminal connections. Single-phase terminal connections.
 - 7 pin connector to supply the module.
 - 30mA Three-phase differential protection.

- N-BUS06. **Distribution Busbar.**
 - Distribution bus-bar module.
 - Local/remote switch.
 - Slide commutators of disconnectors and circuit breaker.
 - Status indicator lamps. ON/OFF switch.
 - Communications connector SUD-D 62 pin.

- N-EALD. **Network Analyzer Unit with Computer Data Acquisition.** (2 units)
 - Power Switch.
 - Input terminals: Three-Phase measurement input terminals with neutral, 400VAC.
 - Output terminals: Three-Phase measurement output terminals with neutral, 400VAC.
 - Communication port Rs485.
 - Supply terminals: Nominal Voltage: 230VAC.
 - Fuses: Line fuses 3x10A.
 - Digital Outputs: Three digital outputs for pulses or alarms, or for combining either.
 - Network Analyzer:
 - It allows to measure the voltage, currents, active power, reactive power, frequencies, energies per phases, armonics, etc.
 - Navigation Joystick: It allows us to navigate with different analyzer parameters.
 - Preselector:
 - This element allows us to preselect different standard measurements:
 - Position 1 : Measurement of phase voltage.
 - Position 2: Measurement of line currents.
 - Position 3: Measurement of line powers.

- N-CFP. **Advanced Power Factor Controller Module.**
 - Automatic power factor controller module.
 - Four quadrants regulation.
 - FCP System (fast computerized program).
 - Compensation stages: 6 relay outputs.
 - LCD display with three digits and more than 20 icons to indicate different operation conditions.
 - ON-OFF switch.

Continue...

EXAMPLE

AEL-MPSS-01

Specifications (continuation)

- **N-PLC03. PLC03 Control Module.**
 - PLC Siemens.
 - Communications connector SUB-D 62 pin.
 - ON-OFF switch
 - 2 x Fuses 2A.

- **N-CAR19T4D. Three-Phase Digital Capacitor Banks Module.**
 - Three-phase digital banks of commutable capacitors module.
 - Three-phase commutable capacitor banks:6x(3x7uF).
 - Signals connector.

- **N-CAR36T3D. Three-Phase Digital Bank of Commutable Inductances Module.**
 - Three-phase digital banks of commutable inductances module.
 - Three load slide commutators.
 - 3 x three-phase commutable inductance banks:3x(3x1,4 H).
 - Local/Remote control switch.
 - ON-OFF switch.
 - Communications connector SUB-D 62 pin.

- **N-CAR35T3D. Three-Phase Digital Bank Resistors Module.**
 - Three-phase digital bank of commutable resistors module.
 - Three load slide commutators.
 - Three-phase commutable resistor banks:3x1 50 ohms (1000W, 2000W, 3000W).
 - Local/Remote control switch.
 - ON-OFF switch.
 - Communications connector SUB-D 62 pin.

- **N-CAR19T3D. Three-Phase Digital Bank of Commutable Capacitors Module.**
 - Three-phase digital banks of commutable capacitors module.
 - Three load slide commutators.
 - 3 x three-phase commutable capacitor banks:3x(3x7uF).
 - Local/Remote control switch.
 - ON-OFF switch.
 - Communications connector SUB-D 62 pin.

- **N-ERP-MA01. Feeder Management Relay Module.**
 - The main functions:
 - Four levels of Phase Instantaneous Overcurrent Element (50P).
 - Four levels of Negative-Sequence Overcurrent Element (50Q).
 - Four levels of Residual Overcurrent Element (50G).
 - Four levels of Neutral Overcurrent Element (50G).
 - Two levels of Phase Time-Overcurrent Element (51P).
 - Two levels of Residual Time-Overcurrent Element (51G).
 - Two levels of Ground Time-Overcurrent Element (51G).
 - One level of Negative-Sequence Time-Overcurrent Element (51Q).
 - Phase to Ground Overvoltage (59G).
 - Phase to Phase Overvoltage (59P).
 - Negative-Sequence Overvoltage (59Q).
 - Residual Overvoltage (59G).
 - Phase to Ground Undervoltage (27G).
 - Phase to Phase Undervoltage (27P).
 - Six levels of Secure Overfrequency (81O).
 - Six levels of Secure Underfrequency (81U).
 - Two levels of Negative Power Flow with Definite Time Delay (32).
 - Two levels of Positive Power Flow with Definite Time Delay (32).
 - Station Battery Monitor.
 - Breaker Wear Monitoring.
 - Synchrophasor Protocol.
 - Peak Demand and Demand Metering.
 - Auto-Reclosing.
 - Creating fault and disturbance records.
 - Accuracy: +- 10%. Current: 5 A (A. C.) Frequency: 50 or 60 Hz
 - Operating time: typically 10 ms to 25 ms.

Continue...

EXAMPLE

AEL-MPSS-01

Specifications (continuation)

•N-ERP-MF01 . **Digital Fault Simulator Module.**

- Faults injection module.
- Preselector of kind of fault:
 - Three-Phase short circuit.
 - Two-phase short circuit.
 - Two-phase to ground short circuit.
 - Single-phase short circuit.
- Local/Remote control switch.
- ON-OFF switch.
- Terminal connections.
- Signals connector SUB-D 62 pins.

SCADA (Supervision, Control and Data Acquisition).

EXERCISES AND PRACTICAL POSSIBILITIES WITH AEL-C-P-02S

Local control:

- 1.- Opening and closing basic maneuvers of isolator switches and circuit breaker of distribution substation.
- 2.- Real time measurements of all electrical parameters of the distribution systems.
- 3.- Studying of short circuits in different points of load power system:
 - a. Symmetric short circuits: three-phase short circuits with and without contact impedance.
 - b. Asymmetric faults:
 - i. Two-phase short circuit with and without contact impedance.
 - ii. Two-phase to ground shortcircuit with and without contact impedance.
 - iii. Single-phase short circuit with and without contact impedance.
- 4.- Recording the evolution of voltage and current phasors during short circuit for further analysis.
- 5.- Studying in depth of feeder protection relay.
- 10.- Remote measurement of all electrical parameters of load distribution system.
- 11.- Remotely control of short circuits in different points of the load power system:
 - a. Symmetric short circuits: three-phase short circuits with and without contact impedance.
 - b. Asymmetric faults:
 - i. Two-phase short circuit with and without contact impedance.
 - ii. Two-phase to ground shortcircuit with and without contact impedance.
 - iii. Single-phase short circuit with and without contact impedance.
- 12.- Recording the evolution of voltage and current phasors during short circuit for further analysis.
- 13.- Studying in depth of feeder protection relay.
- 14.- Automatic power factor compensation in function on the demanded reactive energy.

Remote control (with SCADA System):

- 6.- Supervision, Control and Data Acquisition of all electrical parameters of the load distribution system.
- 7.- Remote control of the demanded active power.
- 8.- Remote control of the demanded inductive reactive power.
- 9.- Remote control of the demanded capacitive reactive power.

*Specifications subject to change without previous notice, due to the convenience of improvements of the product.



C/ Del Agua, 14. Polígono Industrial San José de Valderas.
28918 LEGANÉS. (Madrid). SPAIN.
Phone: 34-91-6199363 FAX: 34-91-6198647
E-mail: edibon@edibon.com WEB site: **www.edibon.com**

REPRESENTATIVE: