

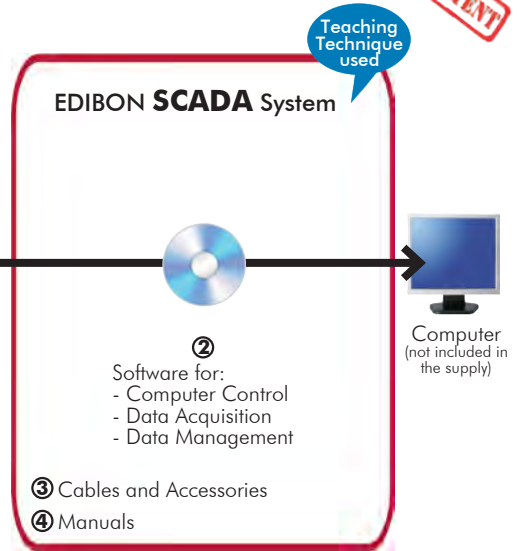

**EDIBON PATENT**



\* Minimum supply always includes: 1 + 2 + 3 + 4 (Computer not included in the supply)

① Unit: AEL-SST-01. Switching in Transmission and Distribution Substations Application

Key features:

- **Advanced Real-Time SCADA.**
- **Open Control + Multicontrol + Real-Time Control.**
- **Specialized EDIBON Control Software based on LabVIEW.**
- **Projector and/or electronic whiteboard compatibility allows the unit to be explained and demonstrated to an entire class at one time.**
- **Capable of doing applied research, real industrial simulation, training courses, etc.**
- **Remote operation and control by the user and remote control for EDIBON technical support, are always included.**
- **Totally safe, utilizing 4 safety systems (Mechanical, Electrical, Electronic & Software).**
- **Designed and manufactured under several quality standards.**
- **Optional ICAI software to create, edit and carry out practical exercises, tests, exams, calculations, etc. Apart from monitoring user's knowledge and progress reached.**
- **This unit has been designed for future expansion and integration. A common expansion is the EDIBON Scada-Net (ESN) System which enables multiple students to simultaneously operate many units in a network.**

**OPEN CONTROL  
+  
MULTICONTROL  
+  
REAL TIME CONTROL**



**www.edibon.com**  
↳ PRODUCTS  
↳ 40.- ELECTRICITY

For more information about Key Features, click here



ISO 9001: Quality Management (for Design, Manufacturing, Commercialization and After-sales service)



European Union Certificate (total safety)



Certificates ISO 14001 and ECO-Management and Audit Scheme (environmental management)



Certificate and Worlddidac Member

## INTRODUCTION

In an electric power system, the energy distribution is the final stage which carries the electricity from transmission stage to the final consumers. A switching substation is the installation where this electric power is managed. This kind of substation works without transformers, and operates only at a single voltage level. One of the functions of these substations are being collector and distribution power stations, but they are also used for switching the current to back-up line or parallelizing circuits in case of faults.

## GENERAL DESCRIPTION

The Switching in Transmission and Distribution Substations Application, "AEL-SST-01", has been designed to study the most common operations carried out in these substations, such as, transference of the electrical service from the first busbar to the second busbar without interruptions of electrical supply, distribution through two lines in parallel, switching on/off of loads, commanding logic switch-disconnector, etc.

To demonstrate these basic principles of working, this application includes two types of busbar modules:

- Double busbar typology. These modules consist of two three-phase sets of busbars with input/output terminals to interconnect with other similar modules (feeders). Each double busbar module has two disconnectors connected each to each busbar and one circuit breaker. Through the circuit breaker, loads, generators, electrical lines, etc. will be supplied. To control the opening / closing orders of disconnectors and circuit breakers, these modules have push-buttons (local control mode) and digital signals inputs (remote control mode).
- Coupling busbar module, it consists of one coupling three-phase circuit breaker between the busbars and two three-phase disconnectors, which allows coupling the two busbars.

In addition, this application includes a network analyzer to measure voltages of different points, currents, power flows of the different feeders, etc. or a three-phase switch to interrupt the current manually or remotely.

The AEL-SST-01 has been designed to be combined with the rest of AEL-TI applications in order to form a system in which the user can learn concepts about generation, transmission, distribution and power consumption.

This application can work remotely through SCADA software AEL-TI-07/CCSO included in the base unit AEL-TI-07. Transmission Application with Synchronous Generator.

The AEL-SST-01 includes the following modules:

- N-ALI01. Industrial Main Power Supply.
- N-EALD. Network Analyzer Unit with Data Acquisition.
- N-BUS08. Distribution Busbar Module (4 units).
- N-BUS09. Coupling Busbar Module.
- N-PSM. Power Switch Module.
- N-REL09. Time Electronic Relay against Overcurrents (1.2 - 7 A).

Additional and recommended modules:

- N-REFT/3C. 3x300W Three-phase Configurable Resistors Module.
- N-INDT/3C. 3x300VAr Three-phase Configurable Inductances Module.
- N-CAR19T/3C. 3x300VAr Three-phase Configurable Capacitors Module.
- N-AE1. Transmission Line Simulator Module.

Complementary applications:

- AEL-TI-01. Analysis of Three-phase Power Lines Application.
- AEL-TI-02. Distribution Transformer with Motor Regulation Application.
- AEL-TI-03. Arc suppression Coil Application.
- AEL-TI-04. Underground Transmission lines Application.
- AEL-TI-05. Parallel and Series Transmission Lines Application.
- AEL-TI-06. Analysis of flow power on Transmission Lines Application.
- AEL-TI-07. Power Transmission Application with Synchronous Generator.
- AEL-SST-02. Switching Substation Protection Application.

Expansion learning software:

In addition, Edibon provides expansion learning software (AEL-SST-01/ICAL) to reinforce knowledge about this field. This software is formed by:

- ECM. EDIBON Classroom Manager (Instructor Software).
- ESL. EDIBON Student Labsoft (Student Software).

The application AEL-SST-01 can be mounted on rack (option A) or on rail (option B):

Option A:

This application needs the following racks.

- N-RACK-A.
- N-RACK-B.

Optionally the AEL-WBR. Electrical Workbench (Rack) can be supplied to place the rack/s.

Option B:

This application can be mounted on rail.

Optionally the AEL-WBC. Electrical Workbench (Rail) can be supplied to mount the modules.

Optionally This Computer Controlled Unit is supplied with the EDIBON Computer Control System (SCADA), and includes: The unit itself + Computer Control, Data Acquisition and Data Management Software Packages, for controlling the process and all parameters involved in the process.



AEL-SST-01 detail

With this unit there are several options and possibilities:

- Main items: 1, 2 and 3.
- Optional items: 4, 5 and 6.

Let us describe first the main items (1 to 3):

① **AEL-TI-07. Unit.**

The application includes the following modules:

- **N-ALI01. Industrial Main Power Supply.**

Supply voltage: 400V AC, 3PH+N+G.

ON-OFF removable key.

Output voltage connections:

Three-Phase + Neutral: 400V AC.

Single-Phase: 230V AC.

Three-Phase supply hose with IP44 3PN+E 32A 400V connecting plug.

Differential magnetothermal, 4 poles, 25A, 300mA AC 6KA.



N-ALI01

- **N-EALD. Network Analyzer Unit with Data Acquisition.**

ON-OFF switch.

Supply voltage: 400V AC.

Input terminals: Input connection with the measurement point.

Output terminals: Output connection with the measurement point.

Digital outputs: Three digital outputs are used for pulses or alarms, or for combining both.

RS-485 Communication port.

Fuses: 3x10 A.

Network Analyzer Display. It shows:

Active, reactive and apparent power.

Active, reactive and apparent energies.

Lines and phase currents.

Line and phase voltages.

Frequencies.

Power Factor.



N-EALD

- **N-BUS08. Distribution Busbar Module (4 units).**

Supply Voltage: 230V AC.

Double busbar topology, with two disconnectors and one circuit breaker.

Two interconnection terminals.

One Power Input/Output to connect lines, generation, loads, etc.

Two push-buttons by each disconnector / circuit breaker to open and close them.

State indications lamps:

Two lamps to indicate the state of busbars.

Three pilot-lights to indicate the state of the circuit breaker and the disconnectors.

Two Ethernet connections.



N-BUS08

- **N-BUS09. Coupling Busbar Module.**

Supply Voltage: 230V AC.

Double busbar topology, with two disconnectors and one circuit breaker. The circuit breaker open and close the circuit between the two busbars.

Two interconnection terminals.

Two push-buttons by each disconnector / circuit breaker to open and close them.

State indications lamps:

Two lamps to indicate the state of busbars.

Three pilot-lights to indicate the state of the circuit breaker and the disconnectors.

Two Ethernet connections.



N-BUS09

- **N-PSM. Power Switch Module.**

Supply voltage: single-phase 230V AC.

Power terminals:

Four power input terminals (3PH+N)

Four power output terminals (3PH+N)

Auxiliary contacts:

One "NO" contact.

One "NC" contact.

Two push-buttons to open / close the power terminals and auxiliary contacts.

Two control contacts of 24V DC.

Two voltage supply outputs of 24V DC.



N-PSM

- **N-REL09. Time Electronic Relay against Overcurrents (1.2 - 7 A).**

Electronic thermal relay.

Overload protection.

Range 1.2 – 7A.

Reset and test function.

1 NONC contact.

Temporization.



N-REL09

Additional and recommended modules:

- **N-REFT/3C. 3x300 W Three-Phase Configurable Resistors Module.**

Configurable Star and Delta connections.

Three banks with three three-phase resistors of 1600 Ω.

Nominal voltage: 400V AC.

Nominal power: 3 x (3 x 300) W.



N-REFT/3C

- **N-INDT/3C. 3x300 Var Three-Phase Configurable Inductances Module.**

Configurable Star and Delta connection.

Three banks with three three-phase inductances of 5 H.

Nominal voltage: 400V AC.

Nominal power: 3 x (3x300) VAR.



N-INDT/3C

- **N-CAR19T/3C. 3x300 Var Three-Phase Configurable Capacitors Module.**

Configurable Star and Delta connection.

Three banks with three three-phase capacitors of 2 μF.

Nominal voltage: 400V AC.

Nominal power: 3 x (3 x 300) VAR.



N-CAR19T/3C

- **N-AE1. Transmission Line Simulator Module.**

Four capacitors banks of 1μF by capacitor to simulate capacitance between lines.

Two capacitors of 1 and 2μF by phase to simulate capacitances between the line and earth.

Two resistors of 15 and 30 Ohm by phase.

One inductance by phase with 33, 78, 140, 193 and 236 mH terminals.

One neutral resistor of 10 Ohm.



N-AE1

- **All necessary cables to realize the practical exercises are included.**

The complete unit includes as well:

**Advanced Real-Time SCADA.**

**Open Control + Multicontrol + Real-Time Control.**

**Specialized EDIBON Control Software based on LabVIEW.**

**Projector and/or electronic whiteboard compatibility allows the unit to be explained and demonstrated to an entire class at one time.**

**Capable of doing applied research, real industrial simulation, training courses, etc.**

**Remote operation and control by the user and remote control for EDIBON technical support, are always included.**

**Totally safe, utilizing 4 safety systems (Mechanical, Electrical, Electronic & Software).**

**Designed and manufactured under several quality standards.**

**Optional ICAI software to create, edit and carry out practical exercises, tests, exams, calculations, etc. Apart from monitoring user's knowledge and progress reached.**

**This unit has been designed for future expansion and integration. A common expansion is the EDIBON Scada-Net (ESN) System which enables multiple students to simultaneously operate many units in a network.**

② **Cables and Accessories**, for normal operation.

③ **Manuals:**

This unit **is supplied with 7 manuals:** Required Services, Assembly and Installation, Control Software, Starting-up, Safety, Maintenance & Practices Manuals.

\*References 1 to 3 are the main items: AEL-SST-01 + Cables and Accessories + Manuals are included in the minimum supply for enabling normal and full operation.

## EXERCISES AND PRACTICAL POSSIBILITIES TO BE DONE WITH THE MAIN ITEMS

- 1.- Basic wiring of double busbar substation.
  - 2.- Double busbar coupling maneuver.
  - 3.- Operation logic with circuit breakers and disconnectors in a double busbar substation.
  - 4.- Load sharing with different feeders.
  - 5.- Busbar changeover without interruption.
  - 6.- Automatic opening of circuit breakers and disconnectors through overcurrent relay. (AEL-SST-02 base unit required)
  - 7.- Voltage drop at the line as function of line length.
  - 8.- Voltage drop at the line as function of the power factor of the load.
  - 9.- Capacitive and inductive power losses on a line.
  - 10.- Compensation of the power factor with capacitors bench.
  - 11.- Remote coupling maneuver of double busbar with SCADA (AEL-TI-07 base unit required).
  - 12.- Remote control operations logic with circuit breakers and disconnectors in switching substations with SCADA (AEL-TI-07 base unit required).
  - 13.- Remote busbar changeover maneuver without interruption of supplying with SCADA (AEL-TI-07 base unit required).
  - 14.- Voltage drop at the line as function of line length with SCADA (AEL-TI-07 base unit required).
  - 15.- Voltage drop at the line as function of the power factor of the load with SCADA (AEL-TI-07 base unit required).
  - 16.- Capacitive and inductive power losses on a line with SCADA (AEL-TI-07 base unit required).
  - 17.- Load sharing with different feeders with SCADA (AEL-TI-07 base unit required).
  - 18.- Remote control operations with circuit breakers and disconnectors with SCADA (AEL-TI-07 base unit required).
  - 19.- Remote electrical measurements in several points of switching substation with SCADA (AEL-TI-07 base unit required).
- Other possibilities to be done with this application:
- 20.- Many students view results simultaneously. To view all results in real time in the classroom it can be used a projector or an electronic whiteboard.
  - 21.- The Computer Control System with AEL-TI-07/CCSOF allows a real industrial simulation.
  - 22.- This application is totally safe as uses mechanical, electric and electronic, and software safety devices.
  - 23.- This application can be used for doing applied research.
  - 24.- This application can be used for giving learning courses to industries even to other Technical Education Institutions.
- Several other exercises can be done and designed by the user.

### REQUIRED SERVICES

- Electrical supply: three-phase, 380V./50 Hz. or 208V./60 Hz., 20 Kw.

### DIMENSIONS AND WEIGHTS

- AEL-SST-01:
- Dimensions: 1000 x 400 x 1600 mm approx.  
(39.37 x 15.75 x 62.99 inches approx.)
  - Weight: 100 Kg. approx.  
(220 pounds approx.)

### AVAILABLE VERSIONS

- Offered in this catalogue:
- AEL-SST-01. Switching and Distribution Power Substations Application.
- Offered in other catalogue:
- AEL-TI-01. Analysis of Three-phase Power Lines Application.
  - AEL-TI-02. Distribution Transformer with Motor Regulation Application.
  - AEL-TI-03. Arc suppression Coil Application.
  - AEL-TI-04. Underground Transmission lines Application.
  - AEL-TI-05. Parallel and Series Transmission Lines Application.
  - AEL-TI-06. Analysis of flow power on Transmission Lines Application.
  - AEL-TI-07. Transmission Application with Synchronous Generator.
  - AEL-SST-02. Switching Substation Protection Application.



SCADA  
Main screen

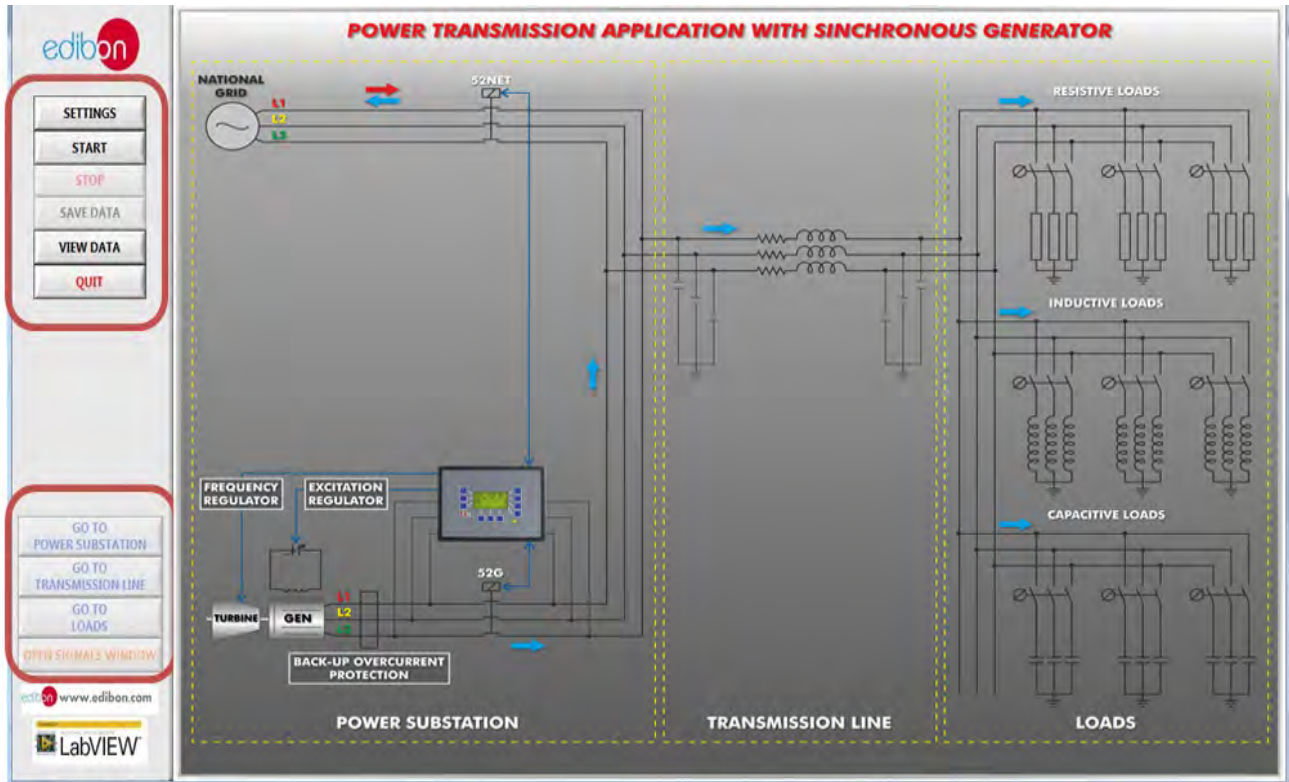

- ① SCADA control menu. It contains the main commands of the system: alarms configuration, start and stop of the system, data saving and viewing saved data.
- ② Screen navigation menu. It is used to change between the specific screens of the system (power substation, transmission line and loads) and to visualize the signals measured in real time (open signals window).
- ③ Diagram of the application.

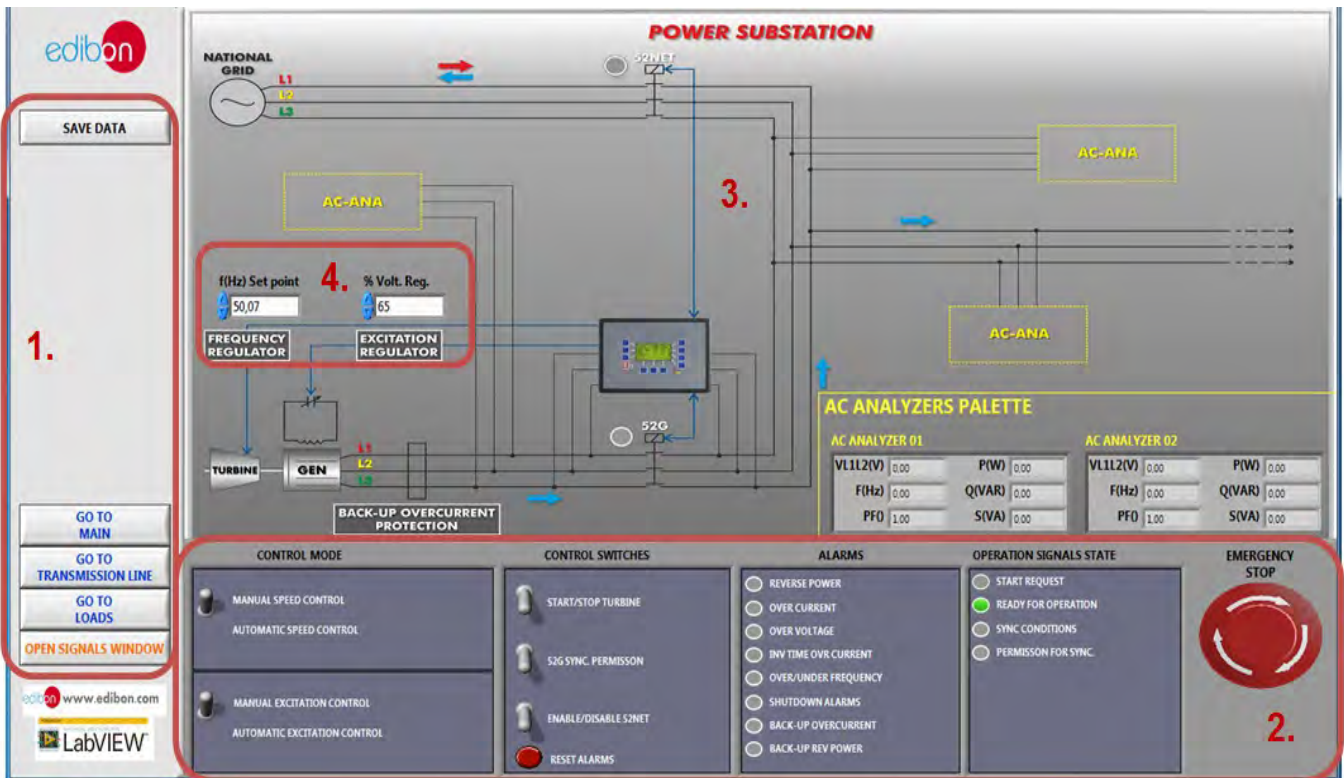

- ① Navigation menu and save data button.
- ② Power substation control panel: - Manual / Automatic Speed Control switch. - Manual / Automatic Excitation Control switch. - Control switches group: Start/Stop turbine, 52G synchronization permission, Enable/Disable 52NET and reset alarms. - Alarms monitoring: Revers power, over current, over voltage, inverse time over current, over frequency, shutdown alarms, back-up over current and back-up reverse power. - Operation signals state: start request, ready for operation, sync conditions, permission for sync. - Emergency stop.
- ③ Diagram of the power substation. In the right of the screen has an "AC analyzers palette" with the measures of the network analyzers. These analyzers can be moved to different positions.
- ④ Manual speed and voltage control regulators.

**Transmission Line menu.** This screen shows a three-phase diagram where the concentrated parameters of the transmission line can be visualized. The impedance of each phase line can be modified changing the resistances, inductances and capacitances values.

**AC ANALYZERS PALETTE**

AC ANALYZER 01		AC ANALYZER 02	
VL1L2(V)	0,00	P(W)	0,00
F(Hz)	50,00	Q(VAR)	0,00
PFO	1,00	S(VA)	0,00

	AC ANALYZER 1 (y1)	AC ANALYZER 2 (y2)	y1 - y2
VLL (V)	0,00	0,00	0,00
P (W)	0,00	0,00	0,00

- ① Navigation menu and save data button.
- ② AC analyzers palette and calculations. These tables show the measures taken by the analyzers and the different between them with the aim of obtain the line losses. The analyzers can be moved to the positions named as AC-ANA in the three-phase diagram.
- ③ Diagram of the transmission line. It has two buttons to save the configuration of the transmission line and to reset them to the factory values.

**Power distribution substation menu.** This screen shows a power distribution system diagram with double bus bar topology. This menu allows carry out all maneuvers relating to these type of power substations, such as coupling bus bars, opening and closing logic of disconnectors and breakers, etc.

**AC ANALYZERS PALETTE**

AC ANALYZER 01		AC ANALYZER 02	
VL1L2(V)	339,50	P1(W)	13,80
f1(Hz)	50,00	Q1(VAR)	12,70
PF10	0,74	S1(VA)	18,70
VL1L2(V)	339,80	P2(W)	0,00
f2(Hz)	50,10	Q2(VAR)	0,00
PF20	1,00	S2(VA)	0,00

**CONTROL PANEL**

Breaker/Disconnector	OPEN	CLOSE
89-1	●	●
89-2	●	●
52	●	●

- ① Navigation menu and save data button.
- ② AC analyzers palette for power distribution substation electrical measurements.
- ③ Power distribution substation diagram. It has the conjunction of lamps which indicate the disconnectors and breakers state.
- ④ Power distribution substation control panel. It has de function of opening and closing of controlling disconnectors and breakers.



**Loads menu.** This screen shows a three-phase diagram where the resistive, inductive and capacitive loads can be visualized.

The screenshot displays the 'LOADS' software interface. On the left, a navigation menu (1) contains buttons for 'SAVE DATA', 'GO TO MAIN', 'GO TO POWER SUBSTATION', 'GO TO TRANSMISSION LINE', and 'OPEN SIGNALS WINDOW'. The main area features a three-phase diagram (3) with phases L1, L2, L3, and a neutral line N. Three load blocks are connected in a star configuration: 'RESISTIVE LOADS' (R(Ohm) x3 = 1600), 'INDUCTIVE LOADS' (L(H) x3 = 20), and 'CAPACITIVE LOADS' (C(uF) x3 = 66). Each load block has a 'STAR CONNECTION' button. Below the diagram is the 'AC ANALYZERS PALETTE' (2), which contains two analyzers (AC ANALYZER 01 and AC ANALYZER 02) with parameters: VL1L2(V), P(W), F(Hz), Q(VAR), PFO, and S(VA). The palette also includes 'SAVE CURRENT IMPEDANCE VALUES' and 'RESET TO FACTORY IMPEDANCE VALUES' buttons. The Edibon logo and LabVIEW logo are visible in the bottom left corner.

- ① Navigation menu and save data button.
- ② AC analyzers palette. It shows the measures taken by the analyzers. The analyzers can be moved to the positions named as AC-ANA in the three-phase diagram.
- ③ Diagram of the loads.

SOME REAL RESULTS OBTAINED FROM THIS UNIT (INCLUDED IN AEL-TI-07 APPLICATION)

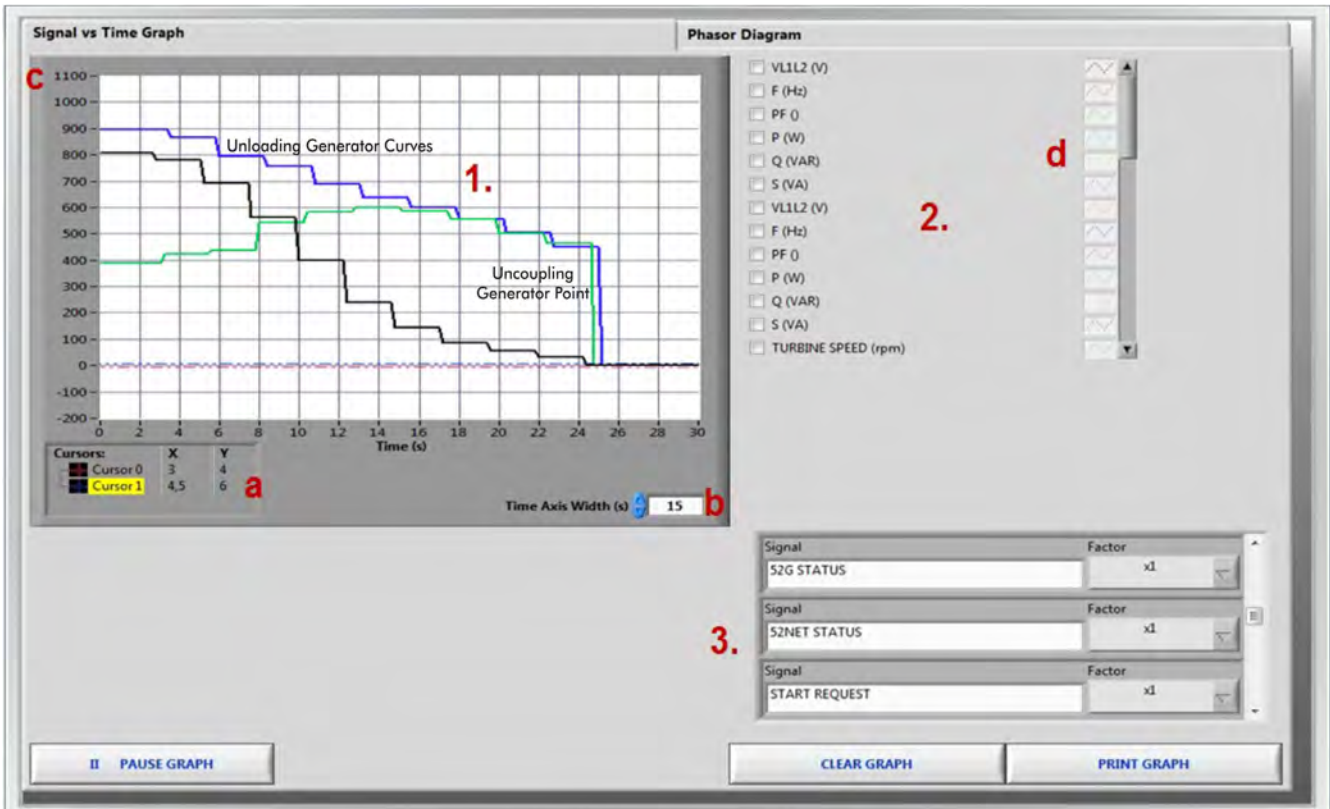

- ① Real time graph. It displays the variables selected and it is possible to take measures using two cursors (a) and modify the time (b) and the amplitude (c) scales. These three curves (apparent, active and reactive powers) represent uncoupling process of the generator and grid.
- ② Variable selector. In this section the variables showed in the real time graph are selected and configured.
- ③ Multiplier of digital variables.

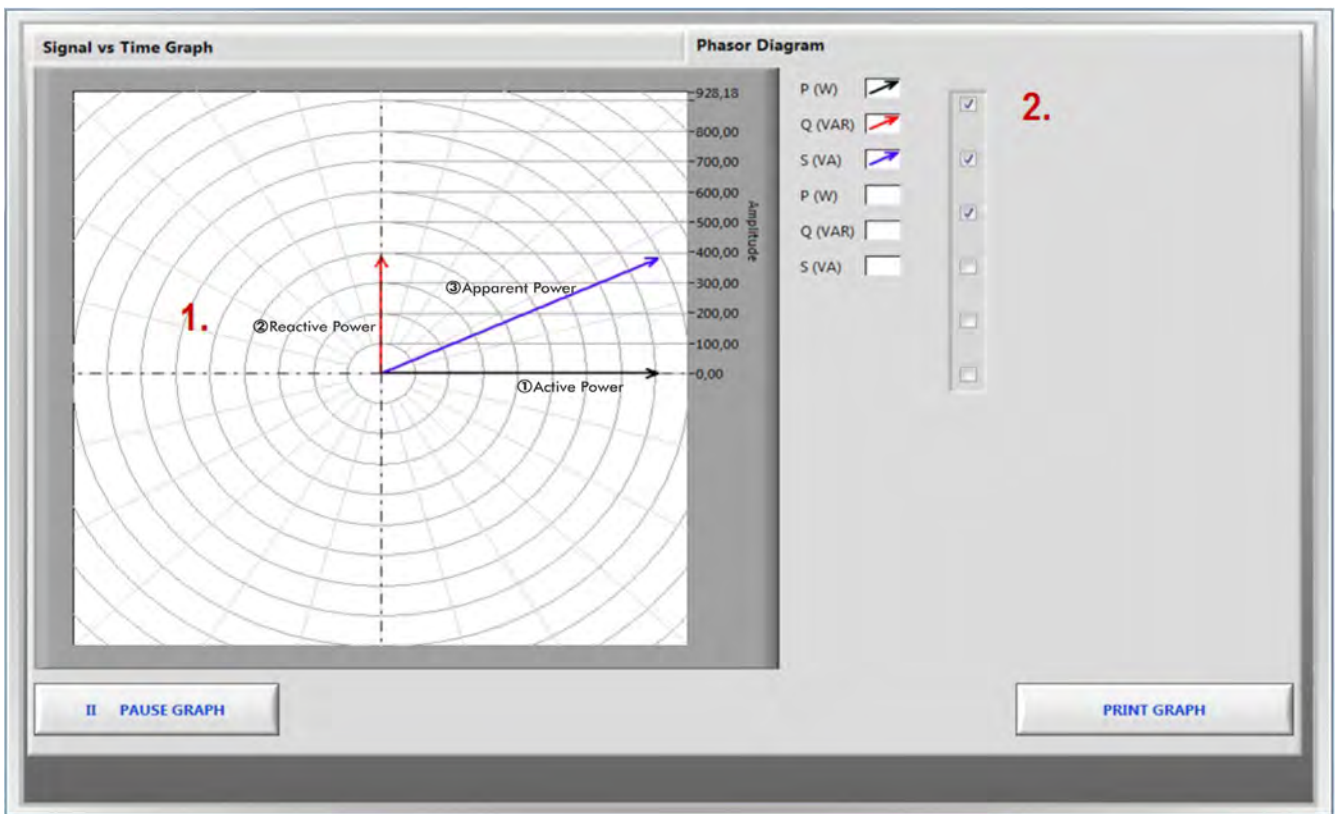

- ① Real time graph. It displays the variables selected. This picture shows the phasors diagram of the active, reactive and apparent powers of the network analyzers.
- ② Variable selector. In this section the variables showed in the real time graph are selected.

Some **real** results obtained from this Unit

This picture shows a PID frequency signal report since the generator is synchronized with the grid till the generator is uncoupled of it.

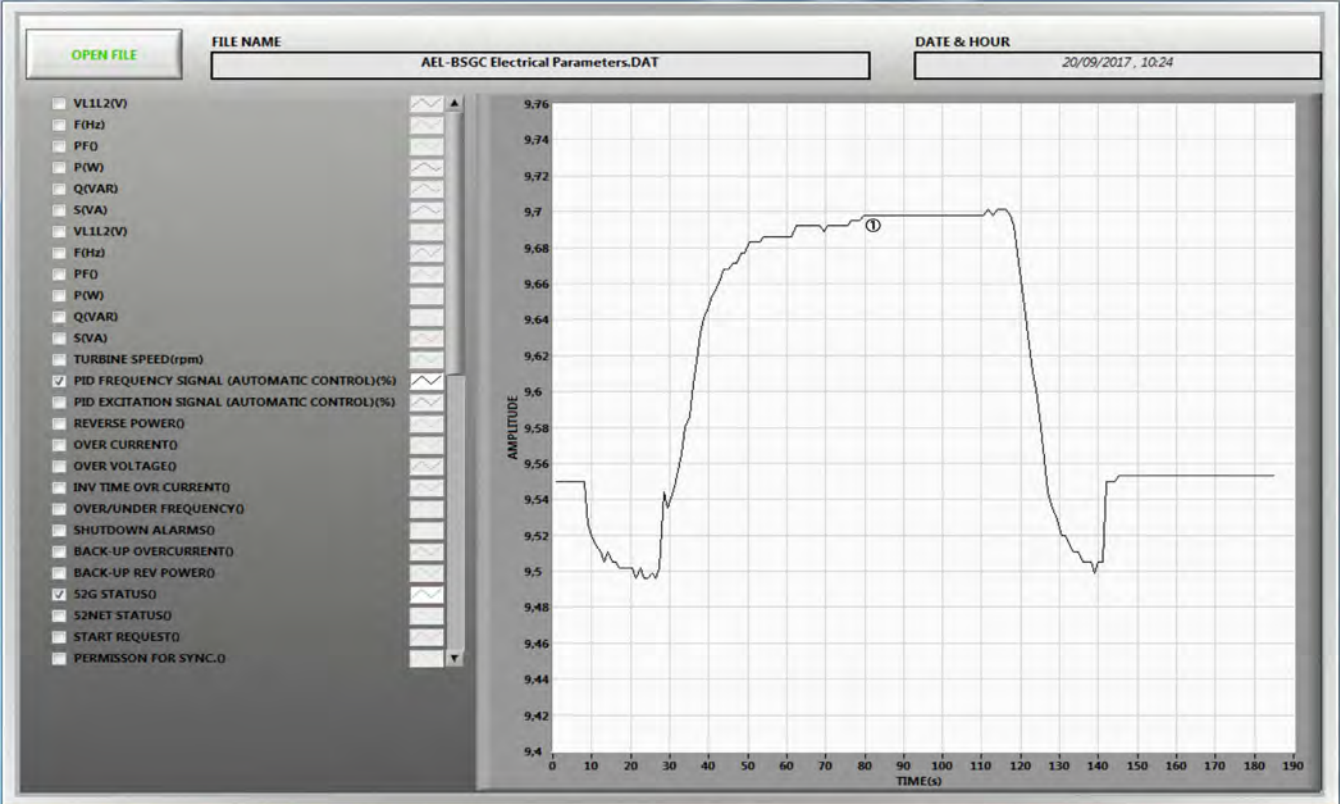

① PID Frequency Signal Reported.

This picture shows the processes of synchronization, active and reactive power generation and uncoupling generator.

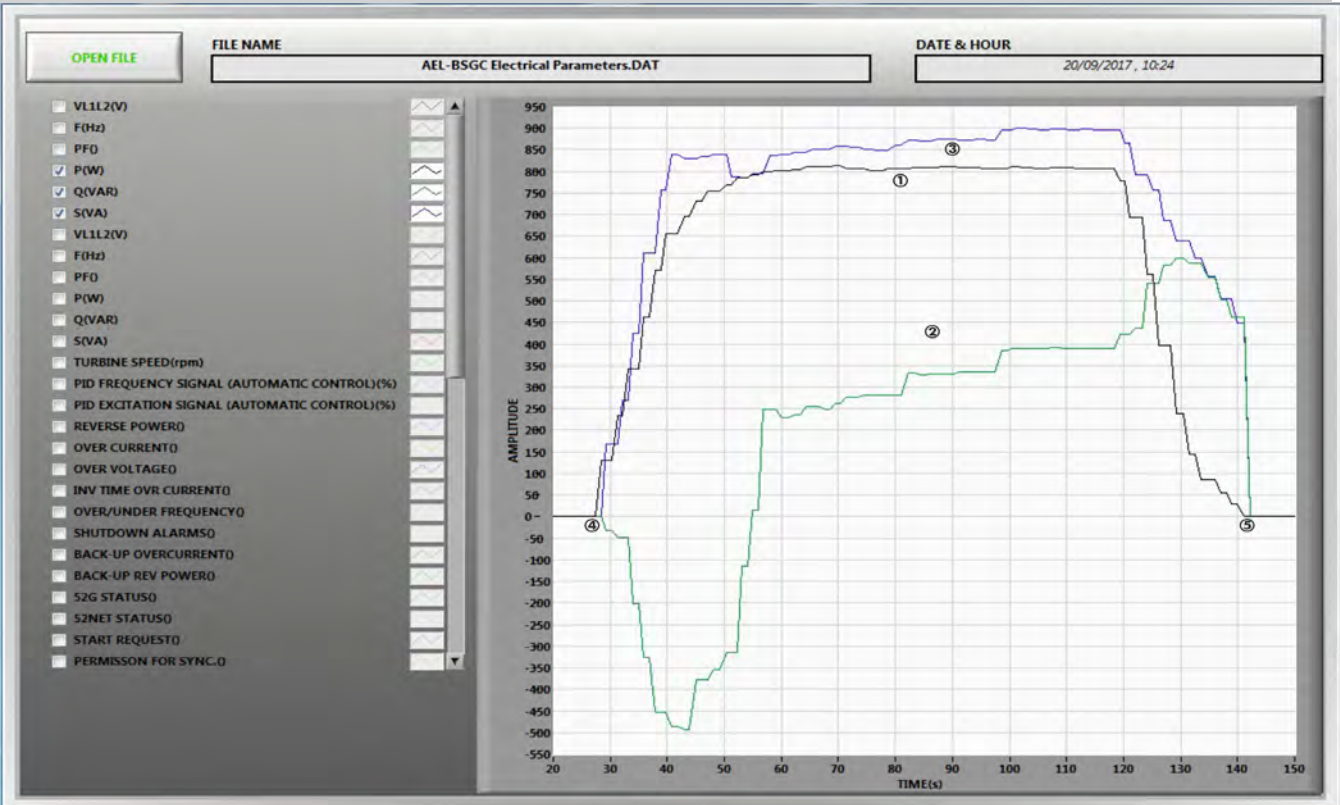

- ① Active power wave.
- ② Reactive power wave.
- ③ Apparent power wave.
- ④ Synchronization.
- ⑤ Uncoupling generator.



## COMPLETE TECHNICAL SPECIFICATIONS (for optional items)

Additionally to the main items (1 to 3) described, we can offer, as optional, other items from 4 to 6.

All these items try to give more possibilities for:

- a) Technical and Vocational Education configuration. (ICAI)
- b) Multipost Expansions options. (MINI ESN and ESN)

### a) Technical and Vocational Education configuration

#### ④ AEL-SST-01/ICAI. Interactive Computer Aided Instruction Software System.

This complete software package consists of an Instructor Software (EDIBON Classroom Manager - ECM-SOF) totally integrated with the Student Software (EDIBON Student Labsoft - ESL-SOF). Both are interconnected so that the teacher knows at any moment what is the theoretical and practical knowledge of the students.

This software is optional and can be used additionally to items (1 to 3).

#### - ECM-SOF. EDIBON Classroom Manager (Instructor Software).

ECM-SOF is the application that allows the Instructor to register students, manage and assign tasks for workgroups, create own content to carry out Practical Exercises, choose one of the evaluation methods to check the Student knowledge and monitor the progression related to the planned tasks for individual students, workgroups, units, etc... so the teacher can know in real time the level of understanding of any student in the classroom.

Innovative features:

- User Data Base Management.
- Administration and assignment of Workgroup, Task and Training sessions.
- Creation and Integration of Practical Exercises and Multimedia Resources.
- Custom Design of Evaluation Methods.
- Creation and assignment of Formulas & Equations.
- Equation System Solver Engine.
- Updatable Contents.
- Report generation, User Progression Monitoring and Statistics.

#### - ESL-SOF. EDIBON Student Labsoft (Student Software).

ESL-SOF is the application addressed to the Students that helps them to understand theoretical concepts by means of practical exercises and to prove their knowledge and progression by performing tests and calculations in addition to Multimedia Resources. Default planned tasks and an Open workgroup are provided by EDIBON to allow the students start working from the first session. Reports and statistics are available to know their progression at any time, as well as explanations for every exercise to reinforce the theoretically acquired technical knowledge.

Innovative features:

- Student Log-In & Self-Registration.
- Existing Tasks checking & Monitoring.
- Default contents & scheduled tasks available to be used from the first session.
- Practical Exercises accomplishment by following the Manual provided by EDIBON.
- Evaluation Methods to prove your knowledge and progression.
- Test self-correction.
- Calculations computing and plotting.
- Equation System Solver Engine.
- User Monitoring Learning & Printable Reports.
- Multimedia-Supported auxiliary resources.

For more information see ICAI catalogue. Click on the following link:

[www.edibon.com/en/files/expansion/ICAI/catalog](http://www.edibon.com/en/files/expansion/ICAI/catalog)

### Instructor Software



ECM-SOF. EDIBON Classroom Manager (Instructor Software) Application Main Screen

ECAL. EDIBON Calculations Program Package - Formula Editor Screen



ERS. EDIBON Results & Statistics Program Package - Student Scores Histogram

ETTE. EDIBON Training Test & Exam Program Package - Main Screen with Numeric Result Question

### Student Software

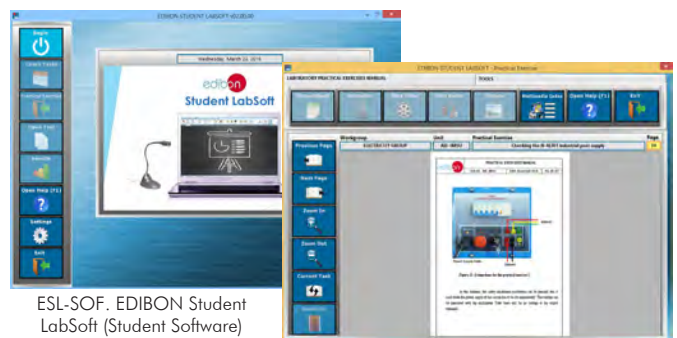

ESL-SOF. EDIBON Student LabSoft (Student Software) Application Main Screen

EPE. EDIBON Practical Exercise Program Package Main Screen

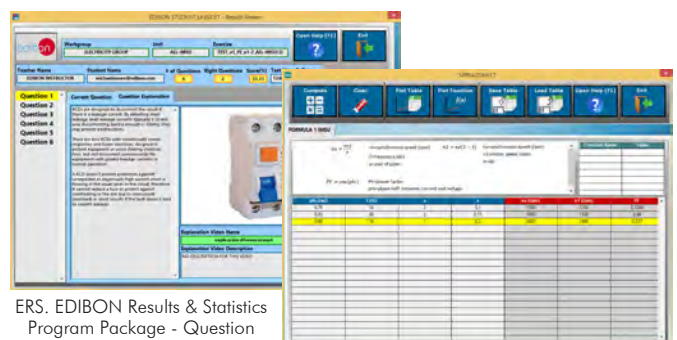

ERS. EDIBON Results & Statistics Program Package - Question Explanation

ECAL. EDIBON Calculations Program Package Main Screen



b) Multipost Expansions options

⑤ **MINI ESN. EDIBON Mini Scada-Net System for being used with EDIBON Teaching Units.**

MINI ESN. EDIBON Mini Scada-Net System allows up to 30 students to work with a Teaching Unit in any laboratory, simultaneously. It is useful for both, Higher Education and/or Technical and Vocational Education.

The MINI ESN system consists of the adaptation of any EDIBON Computer Controlled Unit with SCADA integrated in a local network.

This system allows to view/control the unit remotely, from any computer integrated in the local net (in the classroom), through the main computer connected to the unit. Then, the number of possible users who can work with the same unit is higher than in an usual way of working (usually only one).

Main characteristics:

- It allows up to 30 students to work simultaneously with the EDIBON Computer Controlled Unit with SCADA, connected in a local net.
- Open Control + Multicontrol + Real Time Control + Multi Student Post.
- Instructor controls and explains to all students at the same time.
- Any user/student can work doing "real time" control/multicontrol and visualisation.
- Instructor can see in the computer what any user/student is doing in the unit.
- Continuous communication between the instructor and all the users/students connected.

Main advantages:

- It allows an easier and quicker understanding.
- This system allows you can save time and cost.
- Future expansions with more EDIBON Units.

For more information see MINI ESN catalogue. Click on the following link:

[www.edibon.com/en/files/expansion/MINI-ESN/catalog](http://www.edibon.com/en/files/expansion/MINI-ESN/catalog)

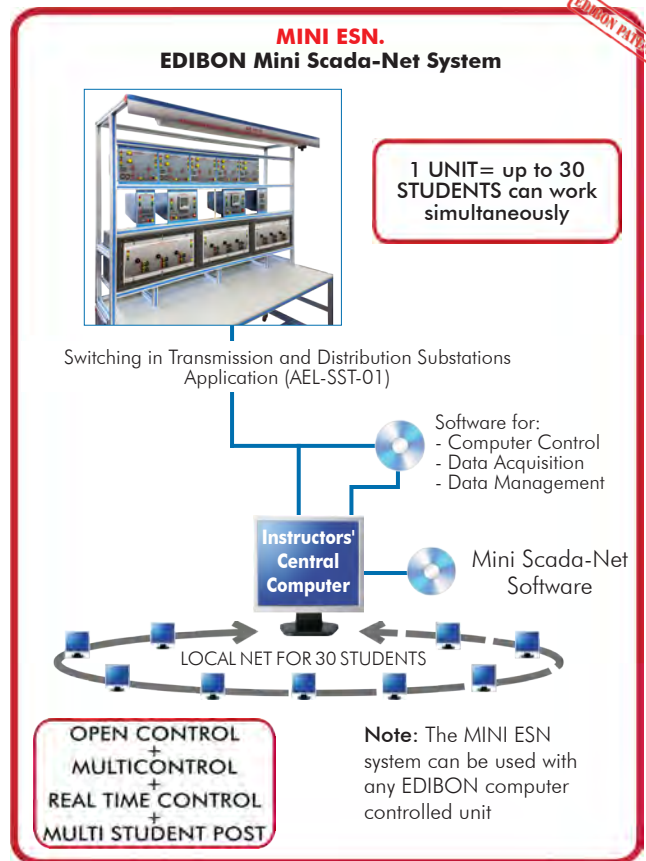

⑥ **ESN. EDIBON Scada-Net Systems.**

This unit can be integrated, in the future, into a Complete Laboratory with many Units and many Students.

For more information see ESN catalogue. Click on the following link:

[www.edibon.com/en/files/expansion/ESN/catalog](http://www.edibon.com/en/files/expansion/ESN/catalog)

## ORDER INFORMATION

### **Main items** (always included in the supply)

Minimum supply always includes:

- ① **Unit: AEL-SST-01. Switching in Transmission and Distribution Substations Application.**
- ② **Cables and Accessories**, for normal operation.
- ③ **Manuals.**

**\*IMPORTANT:** Under AEL-SST-01 we always supply all the elements for immediate running as 1, 2 and 3.

### **Optional items** (supplied under specific order)

a) Technical and Vocational Education configuration

- ④ AEL-SST-01/ICAI. Interactive Computer Aided Instruction Software System.

b) Multipost Expansions options

- ⑤ MINI ESN. EDIBON Mini Scada-Net System for being used with EDIBON Teaching Units.
- ⑥ ESN. EDIBON Scada-Net Systems.

① **AEL-TI-07. Unit.**

The application includes the following modules:

- N-ALI01. Industrial Main Power Supply.  
Supply voltage: 400V AC, 3PH+N+G.  
ON-OFF removable key.  
Output voltage connections:  
Three-Phase + Neutral: 400V AC.  
Single-Phase: 230V AC.  
Three-Phase supply hose with IP44 3PN+E 32A 400V connecting plug.  
Differential magnetothermal, 4 poles, 25A, 300mA AC 6KA.
  - N-EALD. Network Analyzer Unit with Data Acquisition.  
ON-OFF switch.  
Supply voltage: 400V AC.  
Input terminals: Input connection with the measurement point.  
Output terminals: Output connection with the measurement point.  
Digital outputs: Three digital outputs are used for pulses or alarms, or for combining both.  
RS-485 Communication port.  
Fuses: 3x10 A.  
Network Analyzer Display. It shows:  
Active, reactive and apparent power.  
Active, reactive and apparent energies.  
Lines and phase currents.  
Line and phase voltages.  
Frequencies.  
Power Factor.
  - N-BUS08. Distribution Busbar Module (4 units)  
Supply Voltage: 230V AC.  
Double busbar topology, with two disconnectors and one circuit breaker.  
Two interconnection terminals.  
One Power Input/Output to connect lines, generation, loads, etc.  
Two push-buttons by each disconnector / circuit breaker to open and close them.  
State indications lamps:  
Two lamps to indicate the state of busbars.  
Three pilot-lights to indicate the state of the circuit breaker and the disconnectors.  
Two Ethernet connections.
  - N-BUS09. Coupling Busbar Module.  
Supply Voltage: 230V AC.  
Double busbar topology, with two disconnectors and one circuit breaker. The circuit breaker open and close the circuit between the two busbars.  
Two interconnection terminals.  
Two push-buttons by each disconnector / circuit breaker to open and close them.  
State indications lamps:  
Two lamps to indicate the state of busbars.  
Three pilot-lights to indicate the state of the circuit breaker and the disconnectors.  
Two Ethernet connections.
  - N-PSM. Power Switch Module.  
Supply voltage: single-phase 230VAC.  
Power terminals:  
Four power input terminals (3PH+N)  
Four power output terminals (3PH+N)  
Auxiliary contacts:  
One "NO" contact.  
One "NC" contact.  
Two push-buttons to open / close the power terminals and auxiliary contacts.  
Two control contacts of 24V DC.  
Two voltage supply outputs of 24V DC.
  - N-REL09. Time Electronic Relay against Overcurrents (1.2 - 7 A).  
Electronic thermal relay.  
Overload protection.  
Range 1.2 – 7A.  
Reset and test function.  
1 NONC contact.  
Temporization.
- Additional and recommended modules:
- N-REFT/3C. 3x300 W Three-Phase Configurable Resistors Module.  
Configurable Star and Delta connections.  
Three banks with three three-phase resistors of 1600 Ω.  
Nominal voltage: 400V AC.  
Nominal power: 3 x (3 x 300) W.
  - N-INDT/3C. 3x300 Var Three-Phase Configurable Inductances Module.  
Configurable Star and Delta connection.  
Three banks with three three-phase inductances of 5 H.  
Nominal voltage: 400V AC.  
Nominal power: 3 x (3x300) VAR.
  - N-CAR19T/3C. 3x300 Var Three-Phase Configurable Capacitors Module.  
Configurable Star and Delta connection.  
Three banks with three three-phase capacitors of 2 μF.  
Nominal voltage: 400V AC.  
Nominal power: 3 x (3 x 300) VAR.

## Tender Specifications (for main items)

- N-AE1. Transmission Line Simulator Module.
  - Four capacitors banks of 1  $\mu$ F by capacitor to simulate capacitance between lines.
  - Two capacitors of 1 and 2  $\mu$ F by phase to simulate capacitances between the line and earth.
  - Two resistors of 15 and 30 Ohm by phase.
  - One inductance by phase with 33, 78, 140, 193 and 236 mH terminals.
  - One neutral resistor of 10 Ohm.

- All necessary cables to realize the practical exercises are included.

The complete unit includes as well:

Advanced Real-Time SCADA.

Open Control + Multicontrol + Real-Time Control.

Specialized EDIBON Control Software based on LabVIEW.

Projector and/or electronic whiteboard compatibility allows the unit to be explained and demonstrated to an entire class at one time.

Capable of doing applied research, real industrial simulation, training courses, etc.

Remote operation and control by the user and remote control for EDIBON technical support, are always included.

Totally safe, utilizing 4 safety systems (Mechanical, Electrical, Electronic & Software).

Designed and manufactured under several quality standards.

Optional ICAI software to create, edit and carry out practical exercises, tests, exams, calculations, etc. Apart from monitoring user's knowledge and progress reached.

This unit has been designed for future expansion and integration. A common expansion is the EDIBON Scada-Net (ESN) System which enables multiple students to simultaneously operate many units in a network.

② **Cables and Accessories**, for normal operation.

③ **Manuals:**

This unit is supplied with 7 manuals: Required Services, Assembly and Installation, Control Software, Starting-up, Safety, Maintenance & Practices Manuals.

### Exercises and Practical Possibilities to be done with the Main Items

- 1.- Basic wiring of double busbar substation.
  - 2.- Double busbar coupling maneuver.
  - 3.- Operation logic with circuit breakers and disconnectors in a double busbar substation.
  - 4.- Load sharing with different feeders.
  - 5.- Busbar changeover without interruption.
  - 6.- Automatic opening of circuit breakers and disconnectors through overcurrent relay. (AEL-SST-02 base unit required)
  - 7.- Voltage drop at the line as function of line length.
  - 8.- Voltage drop at the line as function of the power factor of the load.
  - 9.- Capacitive and inductive power losses on a line.
  - 10.- Compensation of the power factor with capacitors bench.
  - 11.- Remote coupling maneuver of double busbar with SCADA (AEL-TI-07 base unit required).
  - 12.- Remote control operations logic with circuit breakers and disconnectors in switching substations with SCADA (AEL-TI-07 base unit required).
  - 13.- Remote busbar changeover maneuver without interruption of supplying with SCADA (AEL-TI-07 base unit required).
  - 14.- Voltage drop at the line as function of line length with SCADA (AEL-TI-07 base unit required).
  - 15.- Voltage drop at the line as function of the power factor of the load with SCADA (AEL-TI-07 base unit required).
  - 16.- Capacitive and inductive power losses on a line with SCADA (AEL-TI-07 base unit required).
  - 17.- Load sharing with different feeders with SCADA (AEL-TI-07 base unit required).
  - 18.- Remote control operations with circuit breakers and disconnectors with SCADA (AEL-TI-07 base unit required).
  - 19.- Remote electrical measurements in several points of switching substation with SCADA (AEL-TI-07 base unit required).
- Other possibilities to be done with this application:
- 20.- Many students view results simultaneously. To view all results in real time in the classroom it can be used a projector or an electronic whiteboard.
  - 21.- The Computer Control System with AEL-TI-07/CCSOF allows a real industrial simulation.
  - 22.- This application is totally safe as uses mechanical, electric and electronic, and software safety devices.
  - 23.- This application can be used for doing applied research.
  - 24.- This application can be used for giving learning courses to industries even to other Technical Education Institutions.
- Several other exercises can be done and designed by the user.



## TENDER SPECIFICATIONS (for optional items)

### a) Technical and Vocational Education configuration

#### ⑤ AEL-SST-01/ICAI. Interactive Computer Aided Instruction Software System.

This complete software package consists of an Instructor Software (EDIBON Classroom Manager - ECM-SOF) totally integrated with the Student Software (EDIBON Student Labsoft - ESL-SOF). Both are interconnected so that the teacher knows at any moment what is the theoretical and practical knowledge of the students.

- ECM-SOF. EDIBON Classroom Manager (Instructor Software).

ECM-SOF is the application that allows the Instructor to register students, manage and assign tasks for workgroups, create own content to carry out Practical Exercises, choose one of the evaluation methods to check the Student knowledge and monitor the progression related to the planned tasks for individual students, workgroups, units, etc...so the teacher can know in real time the level of understanding of any student in the classroom.

Innovative features:

- User Data Base Management.
- Administration and assignment of Workgroup, Task and Training sessions.
- Creation and Integration of Practical Exercises and Multimedia Resources.
- Custom Design of Evaluation Methods.
- Creation and assignment of Formulas & Equations.
- Equation System Solver Engine.
- Updatable Contents.
- Report generation, User Progression Monitoring and Statistics.

- ESL-SOF. EDIBON Student Labsoft (Student Software).

ESL-SOF is the application addressed to the Students that helps them to understand theoretical concepts by means of practical exercises and to prove their knowledge and progression by performing tests and calculations in addition to Multimedia Resources. Default planned tasks and an Open workgroup are provided by EDIBON to allow the students start working from the first session. Reports and statistics are available to know their progression at any time, as well as explanations for every exercise to reinforce the theoretically acquired technical knowledge.

Innovative features:

- Student Log-In & Self-Registration.
- Existing Tasks checking & Monitoring.
- Default contents & scheduled tasks available to be used from the first session.
- Practical Exercises accomplishment by following the Manual provided by EDIBON.
- Evaluation Methods to prove your knowledge and progression.
- Test self-correction.
- Calculations computing and plotting.
- Equation System Solver Engine.
- User Monitoring Learning & Printable Reports.
- Multimedia-Supported auxiliary resources.

### b) Multipost Expansions options

#### ⑥ MINI ESN. EDIBON Mini Scada-Net System for being used with EDIBON Teaching Units.

MINI ESN. EDIBON Mini Scada-Net System allows up to 30 students to work with a Teaching Unit in any laboratory, simultaneously.

The MINI ESN system consists of the adaptation of any EDIBON Computer Controlled Unit with SCADA integrated in a local network.

This system allows to view/control the unit remotely, from any computer integrated in the local net (in the classroom), through the main computer connected to the unit.

Main characteristics:

- It allows up to 30 students to work simultaneously with the EDIBON Computer Controlled Unit with SCADA, connected in a local net.
- Open Control + Multicontrol + Real Time Control + Multi Student Post.
- Instructor controls and explains to all students at the same time.
- Any user/student can work doing "real time" control/multicontrol and visualisation.
- Instructor can see in the computer what any user/student is doing in the unit.
- Continuous communication between the instructor and all the users/students connected.

Main advantages:

- It allows an easier and quicker understanding.
- This system allows you can save time and cost.
- Future expansions with more EDIBON Units.

The system basically will consist of:

This system is used with a Computer Controlled Unit.

- Instructor's computer.
- Students' computers.
- Local Network.
- Unit-Control Interface adaptation.
- Unit Software adaptation.
- Webcam.
- MINI ESN Software to control the whole system.
- Cables and accessories required for a normal operation.

\* Specifications subject to change without previous notice, due to the convenience of improvement of the product.



C/ Del Agua, 14. Polígono Industrial San José de Valderas.  
28918 LEGANÉS. (Madrid). ESPAÑA - SPAIN.  
Tel.: 34-91-6199363 Fax: 34-91-6198647

E-mail: [edibon@edibon.com](mailto:edibon@edibon.com) Web: [www.edibon.com](http://www.edibon.com)

Edition: ED01/18  
Date: January/2018

REPRESENTATIVE:

