

# Computer Controlled Heat Pump, Refrigeration and Air Conditioning Unit (two condensers (water and air) and two evaporators (water and air)), with SCADA

**THAR22C**

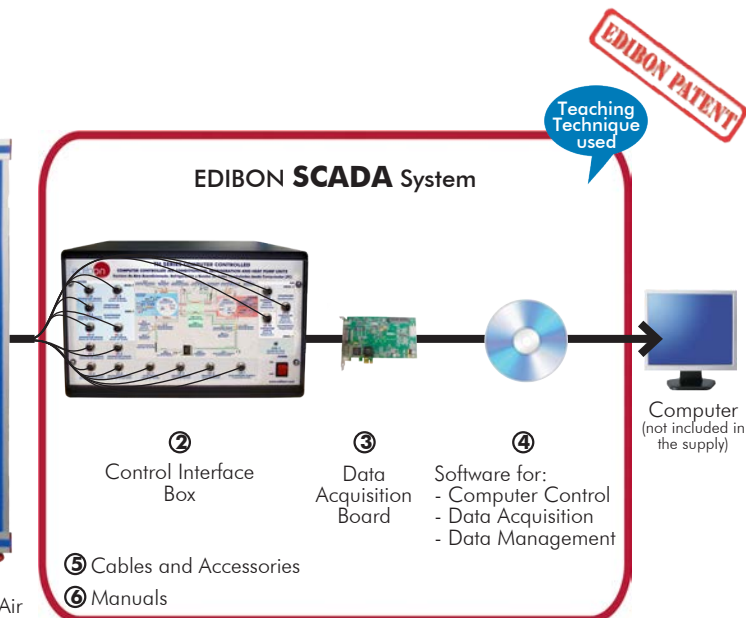

① Unit: THAR22C. Computer Controlled Heat Pump, Refrigeration and Air Conditioning Unit (two condensers (water and air) and two evaporators (water and air))



\* Minimum supply always includes: 1 + 2 + 3 + 4 + 5 + 6  
(Computer not included in the supply)

## Key features:

- **Advanced Real-Time SCADA.**
- **Open Control + Multicontrol + Real-Time Control.**
- **Specialized EDIBON Control Software based on LabVIEW.**
- **National Instruments Data Acquisition board (250 KS/s, kilo samples per second).**
- **Calibration exercises, which are included, teach the user how to calibrate a sensor and the importance of checking the accuracy of the sensors before taking measurements.**
- **Projector and/or electronic whiteboard compatibility allows the unit to be explained and demonstrated to an entire class at one time.**
- **Capable of doing applied research, real industrial simulation, training courses, etc.**
- **Remote operation and control by the user and remote control for EDIBON technical support, are always included.**
- **Totally safe, utilizing 4 safety systems (Mechanical, Electrical, Electronic & Software).**
- **Designed and manufactured under several quality standards.**
- **Optional ICAI software to create, edit and carry out practical exercises, tests, exams, calculations, etc. Apart from monitoring user's knowledge and progress reached.**
- **This unit has been designed for future expansion and integration. A common expansion is the EDIBON Scada-Net (ESN) System which enables multiple students to simultaneously operate many units in a network.**

**OPEN CONTROL  
+  
MULTICONTROL  
+  
REAL TIME CONTROL**

POWERED BY  
NATIONAL INSTRUMENTS  
**LabVIEW™**

**www.edibon.com**

PRODUCTS  
↳ 90.- THERMODYNAMICS  
& THERMOTECHNICS

For more information about Key Features, click here



ISO 9001: Quality Management (for Design, Manufacturing, Commercialization and After-sales service)



European Union Certificate (total safety)



Certificates ISO 14001 and ECO-Management and Audit Scheme (environmental management)



"Worlddidac Quality Charter" and Platinum Member of Worlddidac

## PROCESS DIAGRAM AND UNIT ELEMENTS ALLOCATION

OPEN CONTROL  
+  
MULTICONTROL  
+  
REAL TIME CONTROL

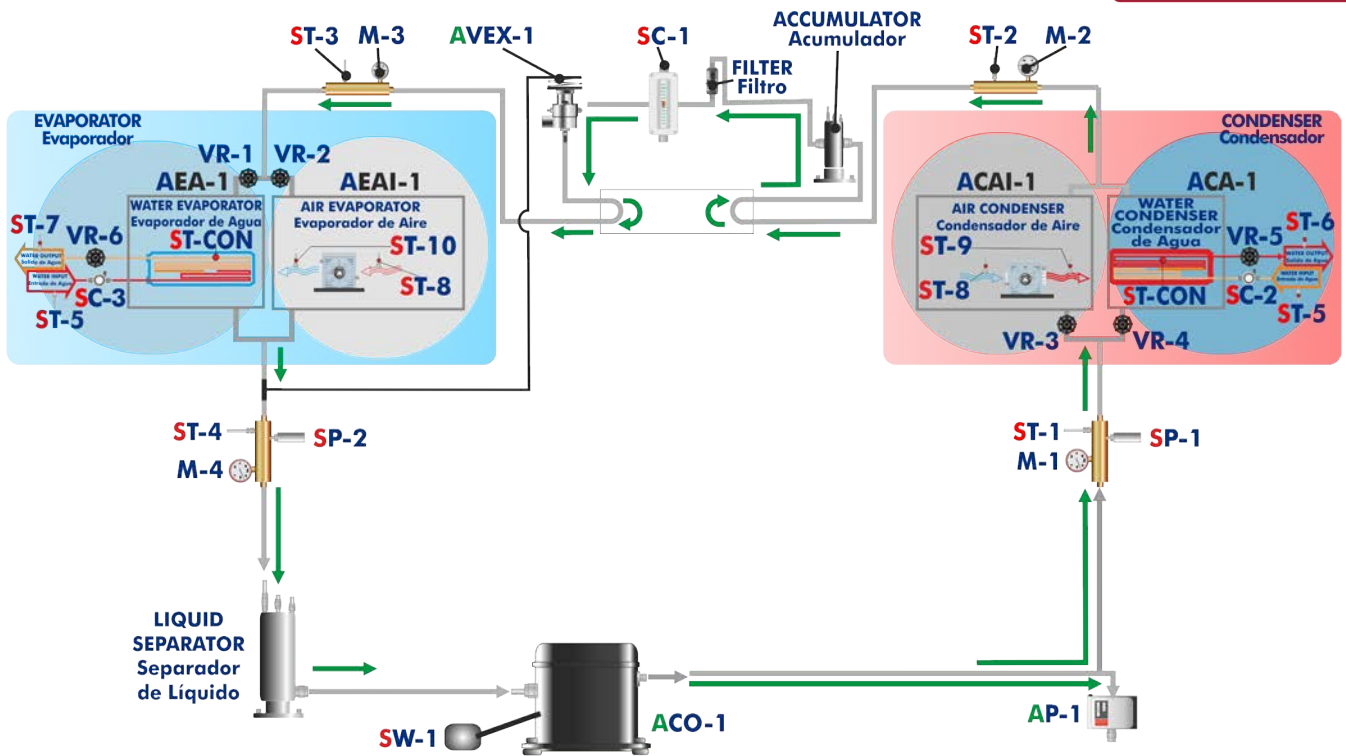

**ST-**  
TEMPERATURE SENSOR  
Sensor de Temperatura

**SC-1**  
FLOW SENSOR  
Sensor de Caudal

**M-**  
MANOMETER  
Manómetro

**SW-**  
POWER SENSOR  
Sensor de Potencia

**AP-**  
HIGH PRESSURE CONTROL  
Presostato de Alta

**VR-**  
REGULATION VALVE  
Válvula de Regulación

**ACO-1**  
COMPRESSOR  
Compresor

**AVEX-**  
EXPANSION VALVE  
Válvula de Expansión

**ST-CON**  
CONTROL TEMPERATURE SENSOR  
Sensor de Control de Temperatura

**SP-**  
PRESSURE SENSOR  
Sensor de Presión

With this unit there are several options and possibilities:

- Main items: 1, 2, 3, 4, 5 and 6.
- Optional items: 7, 8, 9, 10 and 11.

Let us describe first the main items (1 to 6):

① **THAR22C. Unit:**

Bench-top unit.

Anodized aluminum frame and panels made of painted steel.

Main metallic elements made of stainless steel.

Diagram in the front panel with distribution of the elements similar to the real one.

Cooling compressor, computer controlled.

Air condenser, computer controlled.

Water condenser.

High pressure control.

Coolant accumulation tank.

Cooling filter.

Expansion valve.

Water evaporator.

Air evaporator, computer controlled.

Coolant division tank.

Four manometers.

Ten temperature sensors (four sensors measure the cooling temperature, three sensors measure the water temperature, three sensors measure the air temperature):

- Temperature sensor, "J" type (compressor outlet).
- Temperature sensor, "J" type (condenser outlet/evaporator inlet).
- Temperature sensor, "J" type (evaporator inlet/condenser outlet).
- Temperature sensor, "J" type (compressor inlet).
- Temperature sensor, "J" type (water inlet).
- Temperature sensor, "J" type (condenser outlet/evaporator).
- Temperature sensor, "J" type (evaporator outlet/ condenser).
- Temperature sensor, "J" type (room air).
- Temperature sensor, "J" type (condenser outlet/evaporator).
- Temperature sensor, "J" type (evaporator outlet/condenser).

Three flow sensors:

- Cooling flow sensor, range: 5 – 60 l/h.
- Water flow sensor (water condenser), range: 0.25 – 6.5 l/min.
- Water flow sensor (water evaporator), range: 0.25 – 6.5 l/min.

Two pressure sensors:

- Cooling pressure sensor (compressor outlet), range: 0 – 25 bar.
- Cooling pressure sensor (compressor inlet), range: 0 – 10 bar.

Wattmeter.

Enthalpy diagram of the refrigerant R134a.

The complete unit includes as well:

**Advanced Real-Time SCADA.**

**Open Control + Multicontrol + Real-Time Control.**

**Specialized EDIBON Control Software based on LabVIEW.**

**National Instruments Data Acquisition board (250 KS/s, kilo samples per second).**

**Calibration exercises, which are included, teach the user how to calibrate a sensor and the importance of checking the accuracy of the sensors before taking measurements.**

**Projector and/or electronic whiteboard compatibility allows the unit to be explained and demonstrated to an entire class at one time.**

**Capable of doing applied research, real industrial simulation, training courses, etc.**

**Remote operation and control by the user and remote control for EDIBON technical support, are always included.**

**Totally safe, utilizing 4 safety systems (Mechanical, Electrical, Electronic & Software).**

**Designed and manufactured under several quality standards.**

**Optional ICAI software to create, edit and carry out practical exercises, tests, exams, calculations, etc. Apart from monitoring user's knowledge and progress reached.**

**This unit has been designed for future expansion and integration. A common expansion is the EDIBON Scada-Net (ESN) System which enables multiple students to simultaneously operate many units in a network.**



Unit: THAR22C

**② THAR22C/CIB. Control Interface Box:**

The Control Interface Box is part of the SCADA system.

**Control interface box with process diagram in the front panel** and with the same distribution that the different elements located in the unit, for an easy understanding by the student.

All sensors, with their respective signals, are properly manipulated from -10V. to +10V. computer output. Sensors connectors in the interface have different pines numbers (from 2 to 16), to avoid connection errors.

Single cable between the control interface box and computer.

**The unit control elements are permanently computer controlled**, without necessity of changes or connections during the whole process test procedure.

**Simultaneous visualization in the computer of all parameters involved in the process.**

**Calibration of all sensors involved in the process.**

**Real time curves representation about system responses.**

Storage of all the process data and results in a file.

Graphic representation, in real time, of all the process/system responses.

**All the actuators' values can be changed at any time from the keyboard** allowing the analysis about curves and responses of the whole process.

All the actuators and sensors values and their responses are displayed on only one screen in the computer.

**Shield and filtered signals to avoid external interferences.**

**Real time computer control with flexibility of modifications from the computer keyboard of the parameters, at any moment during the process.**

Real time computer control for pumps, compressors, heating elements, control valves, etc.

**Real time computer control for parameters involved in the process simultaneously.**

**Open control** allowing modifications, at any moment and in real time, of parameters involved in the process simultaneously.

**Three safety levels, one mechanical in the unit, another electronic in the control interface and the third one in the control software.**



THAR22C/CIB

**③ DAB. Data Acquisition Board:**

The Data Acquisition board is part of the SCADA system.

PCI Express Data acquisition board (National Instruments) to be placed in a computer slot. Bus PCI Express.

**Analog input:**

Number of channels= 16 single-ended or 8 differential. Resolution= 16 bits, 1 in 65536.

**Sampling rate up to: 250 KS/s (kilo samples per second).**

Input range (V)= ±10 V. Data transfers=DMA, interrupts, programmed I/O. DMA channels=6.

**Analog output:**

Number of channels=2. Resolution= 16 bits, 1 in 65536.

Maximum output rate up to: 900 KS/s.

Output range(V)= ±10 V. Data transfers=DMA, interrupts, programmed I/O.

**Digital Input/Output:**

Number of channels=24 inputs/outputs. D0 or DI Sample Clock frequency: 0 to 100 MHz.

Timing: Number of Counter/timers=4. Resolution: Counter/timers: 32 bits.



DAB

**④ THAR22C/CCSOF. Computer Control + Data Acquisition + Data Management Software:**

The three softwares are part of the SCADA system.

Compatible with actual Windows operating systems. Graphic and intuitive simulation of the process in screen. **Compatible with the industry standards.**

Registration and visualization of all process variables in an automatic and simultaneous way.

**Flexible, open and multicontrol software**, developed with actual windows graphic systems, acting simultaneously on all process parameters.

**Management, processing, comparison and storage of data.**

**Sampling velocity up to 250 KS/s (kilo samples per second).**

**Calibration system for the sensors involved in the process.**

**It allows the registration of the alarms state and the graphic representation in real time.**

Comparative analysis of the obtained data, after the process and modification of the conditions during the process.

**Open software, allowing the teacher to modify texts, instructions. Teacher's and student's passwords** to facilitate the teacher's control on the student, and allowing the access to different work levels.

**This unit allows the 30 students of the classroom to visualize simultaneously all the results and the manipulation of the unit, during the process, by using a projector or an electronic whiteboard.**

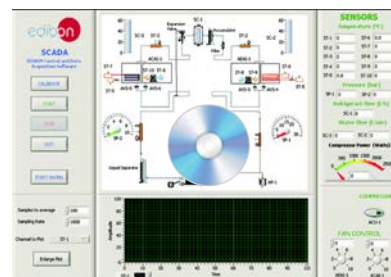

THAR22C/CCSOF

**⑤ Cables and Accessories**, for normal operation.

**⑥ Manuals:**

This unit is **supplied with 8 manuals**: Required Services, Assembly and Installation, Interface and Control Software, Starting-up, Safety, Maintenance, Calibration & Practices Manuals.

\*References 1 to 6 are the main items: THAR22C + THAR22C/CIB + DAB + THAR22C/CCSOF + Cables and Accessories + Manuals are included in the minimum supply for enabling normal and full operation.

## EXERCISES AND PRACTICAL POSSIBILITIES TO BE DONE WITH THE MAIN ITEMS

- |  |  |
|--|--|
| <ol style="list-style-type: none"> <li>1.- Determination of the inlet power, heat produced and performance coefficient. Water as heat source. (Water-water heat pump).</li> <li>2.- Determination of the inlet power, produced heat and performance coefficient. Air as heat source. (Water-air heat pump).</li> <li>3.- Determination of the inlet power, produced heat and performance coefficient. Air as heat source. (Air-air heat pump).</li> <li>4.- Determination of the inlet power, heat produced and performance coefficient. Water as heat source. (Air-water heat pump).</li> <li>5.- Preparation of performance curves of the unit at different inlet and outlet temperatures. Water as heat source. (Water-water heat pump).</li> <li>6.- Preparation of performance curves of the unit at different inlet and outlet temperatures. Air as heat source. (Water-air heat pump).</li> <li>7.- Preparation of performance curves of the unit at different inlet and outlet temperatures. Water as heat source. (Air-water heat pump).</li> <li>8.- Preparation of the performance curves of the unit at different inlet and outlet temperatures. Air as heat source. (Air-air heat pump).</li> <li>9.- Lay out of the steam compression cycle in a diagram P-H and comparison with the ideal cycle. Water as heat source. (Water-water heat pump).</li> <li>10.-Lay out of the steam compression cycle in a diagram P-H and comparison with the ideal cycle. Air as heat source. (Water-air heat pump).</li> <li>11.-Lay out of the steam compression cycle in a diagram P-H and comparison with the ideal cycle. Water as heat source. (Air-water heat pump).</li> <li>12.-Lay out of the steam compression cycle in a diagram P-H and comparison with the ideal cycle. Air as heat source. (Air-air heat pump).</li> <li>13.-Preparation of the performance curves of the unit based on the properties of the refrigerant and at different condensation and evaporation temperatures. Water as heat source. (Water-water heat pump).</li> <li>14.-Preparation of the performance curves of the unit based on the properties of the refrigerant and at different condensation and evaporation temperatures. Air as heat source. (Water-air heat pump).</li> <li>15.-Preparation of the performance curves of the unit based on the properties of the refrigerant and at different condensation and evaporation temperatures. Water as heat source. (Air-water heat pump).</li> <li>16.-Preparation of the performance curves of the unit based on the properties of the refrigerant and at different condensation and evaporation temperatures. Air as heat source. (Air-air heat pump).</li> </ol> | <p>Additional practical possibilities:</p> <ol style="list-style-type: none"> <li>17.-Temperature sensors calibration.</li> <li>18.-Water flow sensors calibration.</li> <li>19.-Refrigerant flow sensor calibration.</li> <li>20.-Pressure sensors calibration.</li> </ol> <p>Other possibilities to be done with this Unit:</p> <ol style="list-style-type: none"> <li>21.-Many students view results simultaneously.<br/>To view all results in real time in the classroom by means of a projector or an electronic whiteboard.</li> <li>22.-Open Control, Multicontrol and Real Time Control.<br/>This unit allows intrinsically and/or extrinsically to change the span, gains; proportional, integral, derivative parameters; etc, in real time.</li> <li>23.-The Computer Control System with SCADA allows a real industrial simulation.</li> <li>24.-This unit is totally safe as uses mechanical, electrical and electronic, and software safety devices.</li> <li>25.-This unit can be used for doing applied research.</li> <li>26.-This unit can be used for giving training courses to Industries even to other Technical Education Institutions.</li> <li>27.-Control of the THAR22C unit process through the control interface box without the computer.</li> <li>28.-Visualization of all the sensors values used in the THAR22C unit process.</li> </ol> <p>- By using PLC-PI additional 19 more exercises can be done.<br/>- Several other exercises can be done and designed by the user.</p> |
|--|--|

### REQUIRED SERVICES

- Electrical supply: single-phase, 220 V/50 Hz or 110 V/60 Hz.
- Water supply and drainage.
- Computer.

### RECOMMENDED ACCESSORIES (Not included)

- For refilling R134a refrigerant and maintenance, we recommend:
- T/KIT1. Maintenance Kit, containing: vacuum pump, hoses and manometers.
  - T/KIT2. Maintenance Kit, containing: leakage detector.
  - R134a refrigerant (to be acquired by the customer locally).

### DIMENSIONS AND WEIGHTS

- THAR22C:
- Unit:
- Dimensions: 900 x 600 x 500 mm approx.  
(35.43 x 23.62 x 19.68 inches approx.)
  - Weight: 100 Kg approx.  
(220.46 pounds approx.)
- Control Interface Box:
- Dimensions: 490 x 330 x 310 mm approx.  
(19.29 x 12.99 x 12.20 inches approx.)
  - Weight: 10 Kg approx.  
(22 pounds approx.)

## AVAILABLE VERSIONS

### Offered in this catalog:

- THAR22C. Computer Controlled Heat Pump, Refrigeration and Air Conditioning Unit (two condensers (water and air) and two evaporators (water and air)).

### Offered in other catalogs:

- THAR22B. Heat Pump, Refrigeration and Air Conditioning Unit (two condensers (water and air) and two evaporators (water and air)).
- THAR2LC. Computer Controlled Refrigeration and Air Conditioning Unit (two condensers (water and air) and one evaporator (water)).
- THAR2LB. Refrigeration and Air Conditioning Unit (two condensers (water and air) and one evaporator (water)).
- THARL2C. Computer Controlled Refrigeration and Air Conditioning Unit (one condenser (water) and two evaporators (water and air)).
- THARL2B. Refrigeration and Air Conditioning Unit (one condenser (water) and two evaporators (water and air)).
- THARA2C. Computer Controlled Refrigeration and Air Conditioning Unit (one condenser (air) and two evaporators (water and air)).
- THARA2B. Refrigeration and Air Conditioning Unit (one condenser (air) and two evaporators (water and air)).
- THARALC. Computer Controlled Refrigeration and Air Conditioning Unit (one condenser (air) and one evaporator (water)).
- THARALB. Refrigeration and Air Conditioning Unit (one condenser (air) and one evaporator (water)).
- THARLLC. Computer Controlled Refrigeration and Air Conditioning Unit (one condenser (water) and one evaporator (water)).
- THARLLB. Refrigeration and Air Conditioning Unit (one condenser (water) and one evaporator (water)).

## SOFTWARE MAIN SCREENS

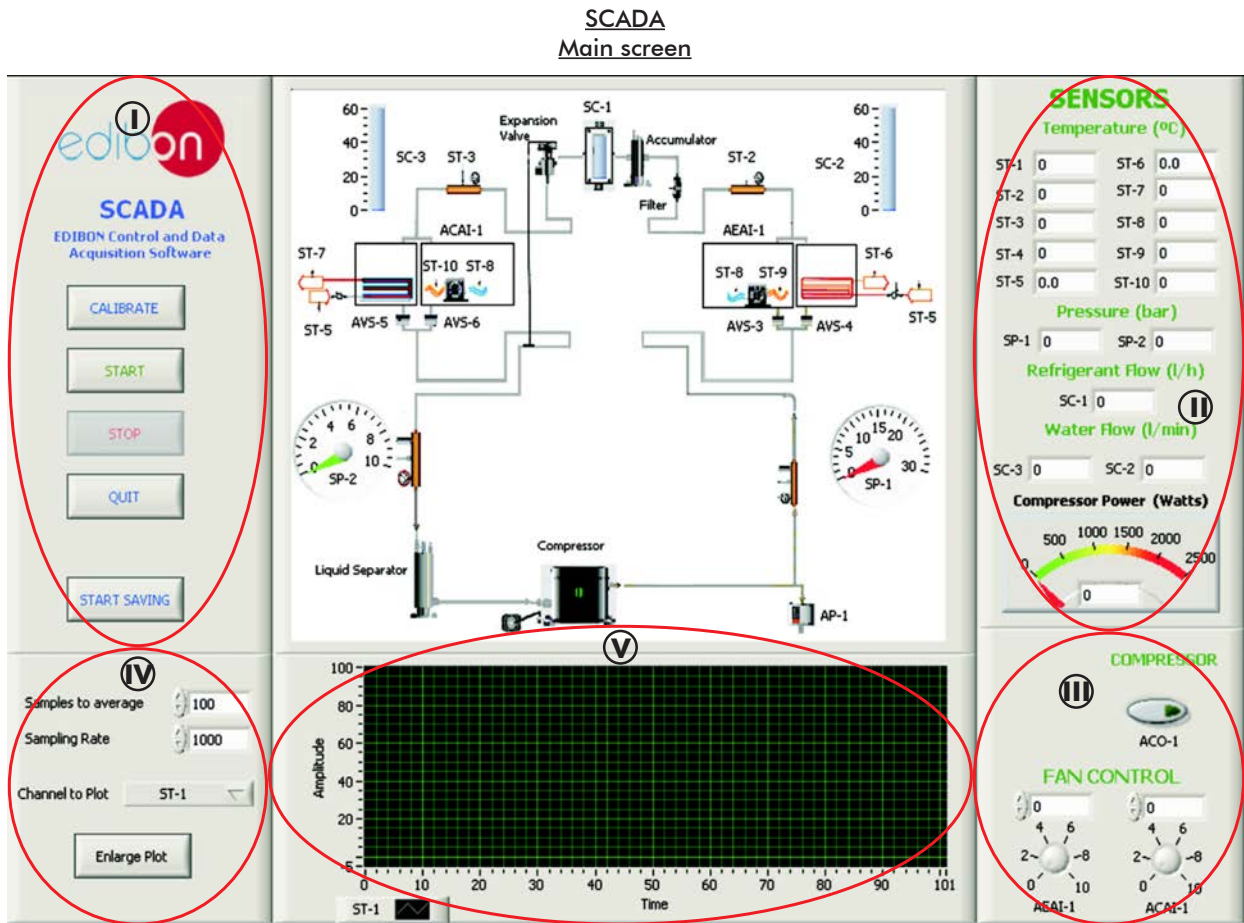

- (I) Main software operation possibilities.
- (II) Sensors displays, real time values, and extra output parameters. Sensors: ST=Temperature sensor. SC=Flow sensor. SP=Pressure sensor.
- (III) Actuators controls. Actuators: ACO=Compressor. AEAI=Air evaporator. ACAI=Air condenser.
- (IV) Channel selection and other plot parameters.
- (V) Real time graphics displays.

### Software for Sensors Calibration

Example of screens

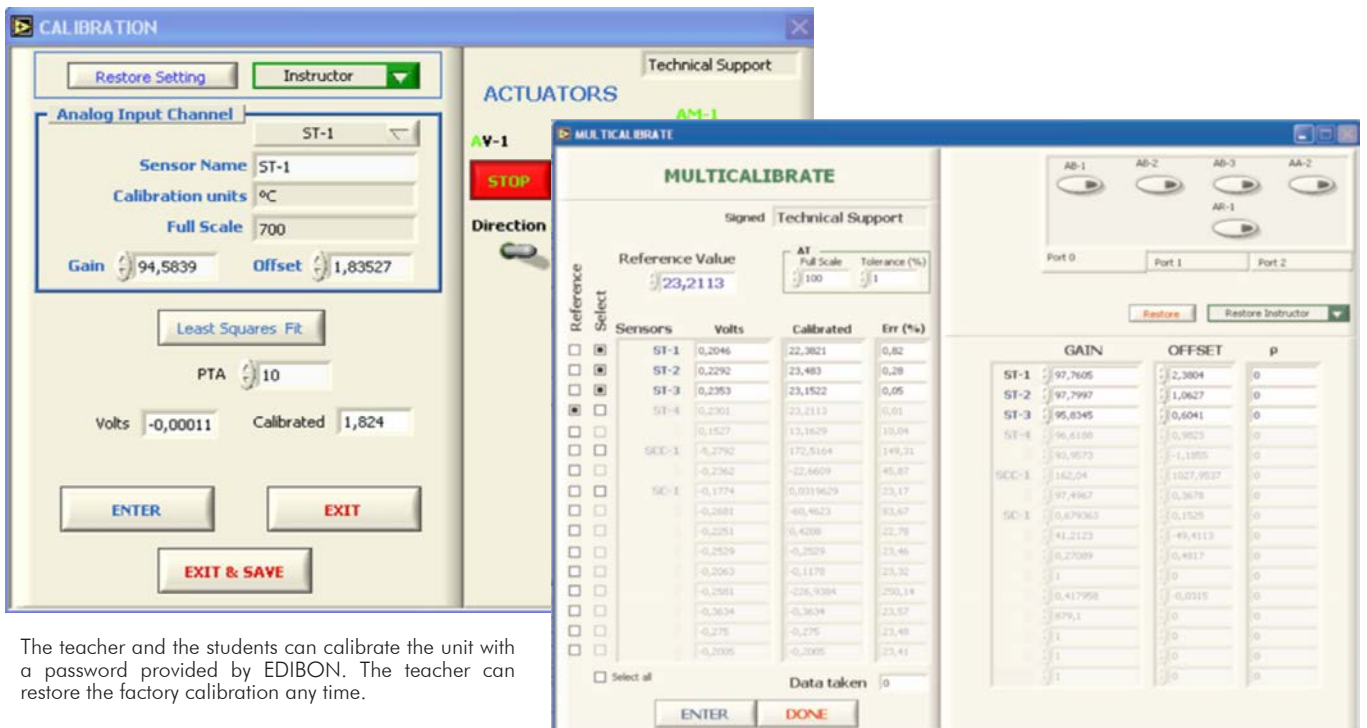

The teacher and the students can calibrate the unit with a password provided by EDIBON. The teacher can restore the factory calibration any time.

## COMPLETE TECHNICAL SPECIFICATIONS (for optional items)

Additionally to the main items (1 to 6) described, we can offer, as optional, other items from 7 to 11.

All these items try to give more possibilities for:

- a) Industrial configuration. (PLC)
- b) Technical and Vocational Education configuration. (ICAI and FSS)
- c) Multipost Expansions options. (MINI ESN and ESN)

### a) Industrial configuration

#### ⑦ **PLC. Industrial Control using PLC** (it includes PLC-PI Module plus PLC-SOF Control Software):

##### **-PLC-PI. PLC Module:**

**Metallic box.**

**Circuit diagram in the module front panel.**

Front panel:

##### **Digital inputs (X) and Digital outputs (Y) block:**

**16 Digital inputs**, activated by switches and 16 LEDs for confirmation (red).

**14 Digital outputs** (through SCSI connector) with 14 LEDs for message (green).

##### **Analog inputs block:**

**16 Analog inputs** (-10 V. to + 10 V.) (through SCSI connector).

##### **Analog outputs block:**

**4 Analog outputs** (-10 V. to + 10 V.) (through SCSI connector).

##### **Touch screen:**

High visibility and multiple functions. Display of a highly visible status. Recipe function. Bar graph function. Flow display function. Alarm list. Multi language function. True type fonts.

Back panel:

Power supply connector. Fuse 2A. RS-232 connector to PC. USB 2.0 connector to PC.

Inside:

Power supply outputs: 24 Vdc, 12 Vdc, -12 Vdc, 12 Vdc variable.

##### **Panasonic PLC:**

**High-speed scan of 0.32  $\mu$ sec.** for a basic instruction.

**Program capacity of 32 Ksteps**, with a sufficient comment area.

Power supply input (100 to 240 V AC).

DC input: 16 (24 V DC).

Relay output: 14.

**High-speed counter.**

Multi-point PID control.

##### **Digital inputs/outputs and analog inputs/outputs Panasonic modules.**

Communication RS232 wire to computer (PC).

Dimensions: 490 x 330 x 310 mm. approx. (19.29 x 12.99 x 12.20 inches approx.). Weight: 30 Kg. approx. (66 pounds approx.).

##### **-THAR22C/PLC-SOF. PLC Control Software:**

**For this particular unit, always included with PLC supply.**

The software has been designed using Labview and it follows the unit operation procedure and linked with the Control Interface Box used in the Computer Controlled Heat Pump, Refrigeration and Air Conditioning Unit (two condensers (water and air) and two evaporators (water and air)) (THAR22C).

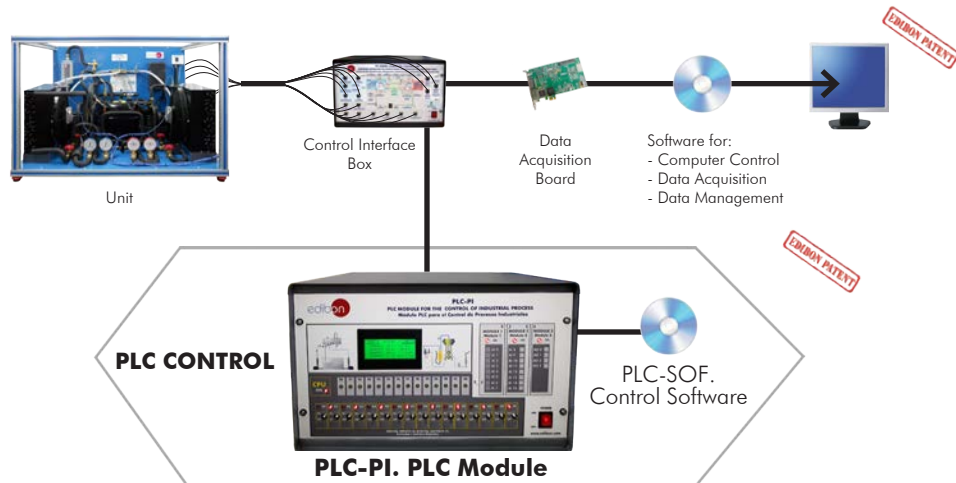

#### Practices to be done with PLC-PI:

- 1.- Control of the particular unit process through the control interface box without the computer.
- 2.- Visualization of all the sensors values used in the particular unit process.
- 3.- Calibration of all sensors included in the particular unit process.
- 4.- Hand on of all the actuators involved in the particular unit process.
- 5.- Realization of different experiments, in automatic way, without having in front the particular unit. (These experiments can be decided previously).
- 6.- Simulation of outside actions, in the cases do not exist hardware elements. (Example: test of complementary tanks, complementary industrial environment to the process to be studied, etc).
- 7.- PLC hardware general use.
- 8.- PLC process application for the particular unit.
- 9.- PLC structure.
- 10.- PLC inputs and outputs configuration.
- 11.- PLC configuration possibilities.
- 12.- PLC program languages.
- 13.- PLC different programming standard languages (ladder diagram (LD), structured text (ST), instructions list (IL), sequential function chart (SFC), function block diagram (FBD)).
- 14.- New configuration and development of new process.
- 15.- Hand on an established process.
- 16.- To visualize and see the results and to make comparisons with the particular unit process.
- 17.- Possibility of creating new process in relation with the particular unit.
- 18.- PLC Programming Exercises.
- 19.- Own PLC applications in accordance with teacher and student requirements.



b) Technical and Vocational Education configuration

⑧ THAR22C/ICAI. Interactive Computer Aided Instruction Software System.

This complete software package consists of an Instructor Software (EDIBON Classroom Manager - ECM-SOF) totally integrated with the Student Software (EDIBON Student Labsoft - ESL-SOF). Both are interconnected so that the teacher knows at any moment what is the theoretical and practical knowledge of the students.

This software is optional and can be used additionally to items (1 to 6).

- ECM-SOF. EDIBON Classroom Manager (Instructor Software).

ECM-SOF is the application that allows the Instructor to register students, manage and assign tasks for workgroups, create own content to carry out Practical Exercises, choose one of the evaluation methods to check the Student knowledge and monitor the progression related to the planned tasks for individual students, workgroups, units, etc... so the teacher can know in real time the level of understanding of any student in the classroom.

Innovative features:

- User Data Base Management.
- Administration and assignment of Workgroup, Task and Training sessions.
- Creation and Integration of Practical Exercises and Multimedia Resources.
- Custom Design of Evaluation Methods.
- Creation and assignment of Formulas & Equations.
- Equation System Solver Engine.
- Updatable Contents.
- Report generation, User Progression Monitoring and Statistics.

- ESL-SOF. EDIBON Student Labsoft (Student Software).

ESL-SOF is the application addressed to the Students that helps them to understand theoretical concepts by means of practical exercises and to prove their knowledge and progression by performing tests and calculations in addition to Multimedia Resources. Default planned tasks and an Open workgroup are provided by EDIBON to allow the students start working from the first session. Reports and statistics are available to know their progression at any time, as well as explanations for every exercise to reinforce the theoretically acquired technical knowledge.

Innovative features:

- Student Log-In & Self-Registration.
- Existing Tasks checking & Monitoring.
- Default contents & scheduled tasks available to be used from the first session.
- Practical Exercises accomplishment by following the Manual provided by EDIBON.
- Evaluation Methods to prove your knowledge and progression.
- Test self-correction.
- Calculations computing and plotting.
- Equation System Solver Engine.
- User Monitoring Learning & Printable Reports.
- Multimedia-Supported auxiliary resources.

For more information see ICAI catalogue. Click on the following link:  
[www.edibon.com/en/files/expansion/ICAI/catalog](http://www.edibon.com/en/files/expansion/ICAI/catalog)

Instructor Software



ECM-SOF. EDIBON Classroom Manager (Instructor Software) Application Main Screen

ECAL. EDIBON Calculations Program Package - Formula Editor Screen



ERS. EDIBON Results & Statistics Program Package - Student Scores Histogram

ETTE. EDIBON Training Test & Exam Program Package - Main Screen with Numeric Result Question

Student Software

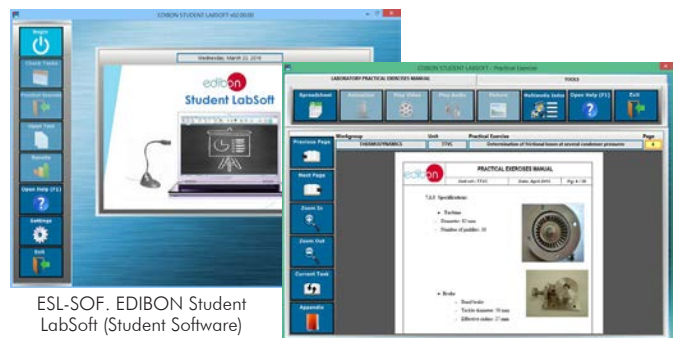

ESL-SOF. EDIBON Student LabSoft (Student Software) Application Main Screen

EPE. EDIBON Practical Exercise Program Package Main Screen

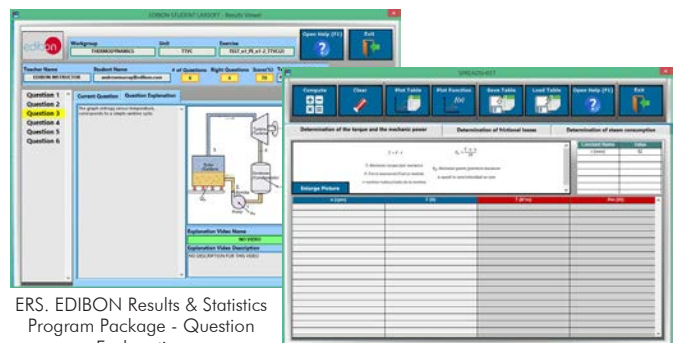

ERS. EDIBON Results & Statistics Program Package - Question Explanation

ECAL. EDIBON Calculations Program Package Main Screen

⑨ **THAR22C/FSS. Faults Simulation System.**

Faults Simulation System (FSS) is a Software package that simulates several faults in any EDIBON Computer Controlled Unit. It is useful for Technical and Vocational level.

The "FAULTS" mode consists in causing several faults in the unit normal operation. The student must find them and solve them. There are several kinds of faults that can be grouped in the following sections:

- Faults affecting the sensors measurement:
  - An incorrect calibration is applied to them.
  - Non-linearity.
- Faults affecting the actuators:
  - Actuators channels interchange at any time during the program execution.
  - Response reduction of an actuator.
- Faults in the controls execution:
  - Inversion of the performance in ON/OFF controls.
  - Reduction or increase of the calculated total response.
  - The action of some controls is annulled.
- On/off faults:
  - Several on/off faults can be included.

Example of some screens

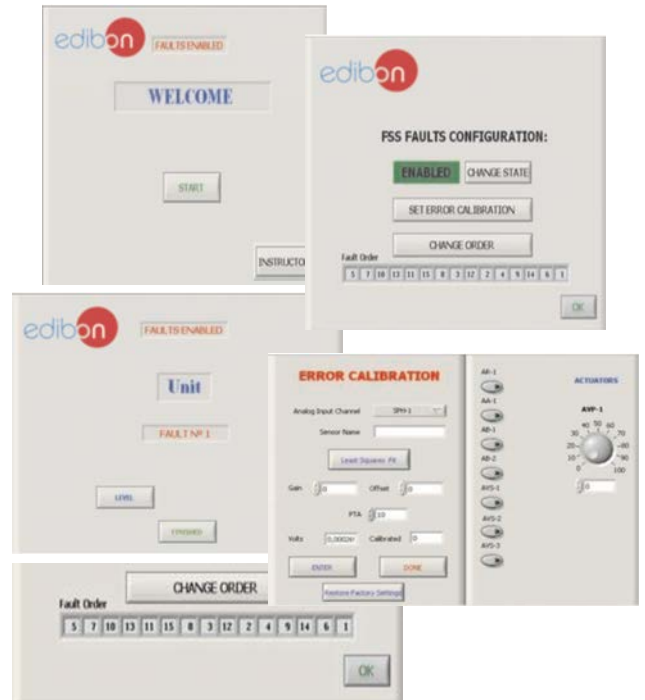

For more information see FSS catalogue. Click on the following link:

[www.edibon.com/en/files/expansion/FSS/catalog](http://www.edibon.com/en/files/expansion/FSS/catalog)

c) Multipost Expansions options

⑩ **MINI ESN. EDIBON Mini Scada-Net System for being used with EDIBON Teaching Units.**

MINI ESN. EDIBON Mini Scada-Net System allows up to 30 students to work with a Teaching Unit in any laboratory, simultaneously. It is useful for both, Higher Education and/or Technical and Vocational Education.

The MINI ESN system consists of the adaptation of any EDIBON Computer Controlled Unit with SCADA integrated in a local network.

This system allows to view/control the unit remotely, from any computer integrated in the local net (in the classroom), through the main computer connected to the unit. Then, the number of possible users who can work with the same unit is higher than in an usual way of working (usually only one).

Main characteristics:

- It allows up to 30 students to work simultaneously with the EDIBON Computer Controlled Unit with SCADA, connected in a local net.
- Open Control + Multicontrol + Real Time Control + Multi Student Post.
- Instructor controls and explains to all students at the same time.
- Any user/student can work doing "real time" control/multicontrol and visualisation.
- Instructor can see in the computer what any user/student is doing in the unit.
- Continuous communication between the instructor and all the users/students connected.

Main advantages:

- It allows an easier and quicker understanding.
- This system allows you can save time and cost.
- Future expansions with more EDIBON Units.

For more information see MINI ESN catalogue. Click on the following link:

[www.edibon.com/en/files/expansion/MINI-ESN/catalog](http://www.edibon.com/en/files/expansion/MINI-ESN/catalog)

⑪ **ESN. EDIBON Scada-Net Systems.**

This unit can be integrated, in the future, into a Complete Laboratory with many Units and many Students.

For more information see ESN catalogue. Click on the following link:

[www.edibon.com/en/files/expansion/ESN/catalog](http://www.edibon.com/en/files/expansion/ESN/catalog)

**MINI ESN.**  
**EDIBON Mini Scada-Net System**



1 UNIT= up to 30 STUDENTS can work simultaneously

Computer Controlled Heat Pump, Refrigeration and Air Conditioning Unit (two condensers (water and air) and two evaporators (water and air)) (THAR22C)

Control Interface Box



Software for:

- Computer Control
- Data Acquisition
- Data Management

Instructors' Central Computer



Mini Scada-Net Software



LOCAL NET FOR 30 STUDENTS



OPEN CONTROL  
+  
MULTICONTROL  
+  
REAL TIME CONTROL  
+  
MULTI STUDENT POST

**Note:** The MINI ESN system can be used with any EDIBON computer controlled unit

## ORDER INFORMATION

### **Main items** (always included in the supply)

Minimum supply always includes:

- ① **Unit: THAR22C. Computer Controlled Heat Pump, Refrigeration and Air Conditioning Unit** (two condensers (water and air) and two evaporators (water and air)).
- ② **THAR22C/CIB. Control Interface Box.**
- ③ **DAB. Data Acquisition Board.**
- ④ **THAR22C/CCSOF. Computer Control + Data Acquisition + Data Management Software.**
- ⑤ **Cables and Accessories**, for normal operation.
- ⑥ **Manuals.**

**\*IMPORTANT:** Under THAR22C we always supply all the elements for immediate running as 1, 2, 3, 4, 5 and 6.

### **Optional items** (supplied under specific order)

#### a) Industrial configuration

- ⑦ PLC. Industrial Control using PLC (it includes PLC-PI Module plus PLC-SOF Control Software):
  - PCL-PI. PLC Module.
  - THAR22C/PLC-SOF. PLC Control Software.

#### b) Technical and Vocational Education configuration

- ⑧ THAR22C/ICAL. Interactive Computer Aided Instruction Software System.
- ⑨ THAR22C/FSS. Faults Simulation System.

#### c) Multipost Expansions options

- ⑩ MINI ESN. EDIBON Mini Scada-Net System for being used with EDIBON Teaching Units.
- ⑪ ESN. EDIBON Scada-Net Systems.

**① THAR22C. Unit:**

Bench-top unit.  
 Anodized aluminum frame and panels made of painted steel.  
 Main metallic elements made of stainless steel.  
 Diagram in the front panel with distribution of the elements similar to the real one.  
 Cooling compressor, computer controlled.  
 Air condenser, computer controlled.  
 Water condenser.  
 High pressure control.  
 Coolant accumulation tank.  
 Cooling filter.  
 Expansion valve.  
 Water evaporator.  
 Air evaporator, computer controlled.  
 Coolant division tank.  
 Four manometers.  
 Ten temperature sensors (four sensors measure the cooling temperature, three sensors measure the water temperature, three sensors measure the air temperature):  
 Temperature sensor, "J" type (compressor outlet).  
 Temperature sensor, "J" type (condenser outlet/evaporator inlet).  
 Temperature sensor, "J" type (evaporator inlet/condenser outlet).  
 Temperature sensor, "J" type (compressor inlet).  
 Temperature sensor, "J" type (water inlet).  
 Temperature sensor, "J" type (condenser outlet/evaporator).  
 Temperature sensor, "J" type (evaporator outlet/ condenser).  
 Temperature sensor, "J" type (room air).  
 Temperature sensor, "J" type (condenser outlet/evaporator).  
 Temperature sensor, "J" type (evaporator outlet/condenser).  
 Three flow sensors:  
 Cooling flow sensor, range: 5 – 60 l/h.  
 Water flow sensor (water condenser), range: 0.25 – 6.5 l/min.  
 Water flow sensor (water evaporator), range: 0.25 – 6.5 l/min.  
 Two pressure sensors:  
 Cooling pressure sensor (compressor outlet), range: 0 – 25 bar.  
 Cooling pressure sensor (compressor inlet), range: 0 – 10 bar.  
 Wattmeter.  
 Enthalpy diagram of the refrigerant R134a.  
 The complete unit includes as well:  
 Advanced Real-Time SCADA.  
 Open Control + Multicontrol + Real-Time Control.  
 Specialized EDIBON Control Software based on LabVIEW.  
 National Instruments Data Acquisition board (250 KS/s, kilo samples per second).  
 Calibration exercises, which are included, teach the user how to calibrate a sensor and the importance of checking the accuracy of the sensors before taking measurements.  
 Projector and/or electronic whiteboard compatibility allows the unit to be explained and demonstrated to an entire class at one time.  
 Capable of doing applied research, real industrial simulation, training courses, etc.  
 Remote operation and control by the user and remote control for EDIBON technical support, are always included.  
 Totally safe, utilizing 4 safety systems (Mechanical, Electrical, Electronic & Software).  
 Designed and manufactured under several quality standards.  
 Optional ICAI software to create, edit and carry out practical exercises, tests, exams, calculations, etc. Apart from monitoring user's knowledge and progress reached.  
 This unit has been designed for future expansion and integration. A common expansion is the EDIBON Scada-Net (ESN) System which enables multiple students to simultaneously operate many units in a network.

**② THAR22C/CIB. Control Interface Box:**

The Control Interface Box is part of the SCADA system.  
 Control interface box with process diagram in the front panel.  
 The unit control elements are permanently computer controlled.  
 Simultaneous visualization in the computer of all parameters involved in the process.  
 Calibration of all sensors involved in the process.  
 Real time curves representation about system responses.  
 All the actuators' values can be changed at any time from the keyboard allowing the analysis about curves and responses of the whole process.  
 Shield and filtered signals to avoid external interferences.  
 Real time computer control with flexibility of modifications from the computer keyboard of the parameters, at any moment during the process.  
 Real time computer control for parameters involved in the process simultaneously.  
 Open control allowing modifications, at any moment and in real time, of parameters involved in the process simultaneously.  
 Three safety levels, one mechanical in the unit, another electronic in the control interface and the third one in the control software.

**③ DAB. Data Acquisition Board:**

The Data Acquisition board is part of the SCADA system.  
 PCI Express Data acquisition board (National Instruments) to be placed in a computer slot.  
 Analog input: Channels= 16 single-ended or 8 differential. Resolution=16 bits, 1 in 65536. Sampling rate up to: 250 KS/s (kilo samples per second).  
 Analog output: Channels=2. Resolution=16 bits, 1 in 65536.  
 Digital Input/Output: Channels=24 inputs/outputs.

**④ THAR22C/CCSOF. Computer Control +Data Acquisition+Data Management Software:**

The three softwares are part of the SCADA system.  
 Compatible with the industry standards.  
 Flexible, open and multicontrol software, developed with actual windows graphic systems, acting simultaneously on all process parameters.  
 Management, processing, comparison and storage of data.  
 Sampling velocity up to 250 KS/s (kilo samples per second).  
 Calibration system for the sensors involved in the process.  
 It allows the registration of the alarms state and the graphic representation in real time.  
 Open software, allowing the teacher to modify texts, instructions. Teacher's and student's passwords to facilitate the teacher's control on the student, and allowing the access to different work levels.  
 This unit allows the 30 students of the classroom to visualize simultaneously all the results and the manipulation of the unit, during the process, by using a projector or an electronic whiteboard.

**⑤ Cables and Accessories,** for normal operation.

**⑥ Manuals:**

This unit is supplied with 8 manuals: Required Services, Assembly and Installation, Interface and Control Software, Starting-up, Safety, Maintenance, Calibration & Practices Manuals.

### Exercises and Practical Possibilities to be done with the Main Items

- 1.- Determination of the inlet power, heat produced and performance coefficient. Water as heat source. (Water-water heat pump).
  - 2.- Determination of the inlet power, produced heat and performance coefficient. Air as heat source. (Water-air heat pump).
  - 3.- Determination of the inlet power, produced heat and performance coefficient. Air as heat source. (Air-air heat pump).
  - 4.- Determination of the inlet power, heat produced and performance coefficient. Water as heat source. (Air-water heat pump).
  - 5.- Preparation of performance curves of the unit at different inlet and outlet temperatures. Water as heat source. (Water-water heat pump).
  - 6.- Preparation of performance curves of the unit at different inlet and outlet temperatures. Air as heat source. (Water-air heat pump).
  - 7.- Preparation of performance curves of the unit at different inlet and outlet temperatures. Water as heat source. (Air-water heat pump).
  - 8.- Preparation of the performance curves of the unit at different inlet and outlet temperatures. Air as heat source. (Air-air heat pump).
  - 9.- Lay out of the steam compression cycle in a diagram P-H and comparison with the ideal cycle. Water as heat source. (Water-water heat pump).
  - 10.-Lay out of the steam compression cycle in a diagram P-H and comparison with the ideal cycle. Air as heat source. (Water-air heat pump).
  - 11.-Lay out of the steam compression cycle in a diagram P-H and comparison with the ideal cycle. Water as heat source. (Air-water heat pump).
  - 12.-Lay out of the steam compression cycle in a diagram P-H and comparison with the ideal cycle. Air as heat source. (Air-air heat pump).
  - 13.-Preparation of the performance curves of the unit based on the properties of the refrigerant and at different condensation and evaporation temperatures.  
Water as heat source. (Water-water heat pump).
  - 14.-Preparation of the performance curves of the unit based on the properties of the refrigerant and at different condensation and evaporation temperatures.  
Air as heat source. (Water-air heat pump).
  - 15.-Preparation of the performance curves of the unit based on the properties of the refrigerant and at different condensation and evaporation temperatures.  
Water as heat source. (Air-water heat pump).
  - 16.-Preparation of the performance curves of the unit based on the properties of the refrigerant and at different condensation and evaporation temperatures.  
Air as heat source. (Air-air heat pump).
- Additional practical possibilities:
- 17.-Temperature sensors calibration.
  - 18.-Water flow sensors calibration.
  - 19.-Refrigerant flow sensor calibration.
  - 20.-Pressure sensors calibration.
- Other possibilities to be done with this Unit:
- 21.-Many students view results simultaneously.  
To view all results in real time in the classroom by means of a projector or an electronic whiteboard.
  - 22.-Open Control, Multicontrol and Real Time Control.  
This unit allows intrinsically and/or extrinsically to change the span, gains; proportional, integral, derivative parameters; etc, in real time.
  - 23.-The Computer Control System with SCADA allows a real industrial simulation.
  - 24.-This unit is totally safe as uses mechanical, electrical and electronic, and software safety devices.
  - 25.-This unit can be used for doing applied research.
  - 26.-This unit can be used for giving training courses to Industries even to other Technical Education Institutions.
  - 27.-Control of the THAR22C unit process through the control interface box without the computer.
  - 28.-Visualization of all the sensors values used in the THAR22C unit process.
- By using PLC-PI additional 19 more exercises can be done.
  - Several other exercises can be done and designed by the user.

## TENDER SPECIFICATIONS (for optional items)

### a) Industrial configuration

#### ⑦ **PLC. Industrial Control using PLC** (it includes PLC-PI Module plus PLC-SOF Control Software):

##### **-PLC-PI. PLC Module:**

Metallic box.

Circuit diagram in the module front panel.

Digital inputs (X) and Digital outputs (Y) block: 16 Digital inputs. 14 Digital outputs.

Analog inputs block: 16 Analog inputs.

Analog outputs block: 4 Analog outputs.

Touch screen.

Panasonic PLC:

High-speed scan of 0.32  $\mu$ sec. Program capacity of 32 Ksteps. High-speed counter. Multi-point PID control.

Digital inputs/outputs and analog inputs/outputs Panasonic modules.

##### **-THAR22C/PLC-SOF. PLC Control Software:**

For this particular unit, always included with PLC supply.

##### **Practices to be done with PLC-PI:**

- 1.- Control of the particular unit process through the control interface box without the computer.
- 2.- Visualization of all the sensors values used in the particular unit process.
- 3.- Calibration of all sensors included in the particular unit process.
- 4.- Hand on of all the actuators involved in the particular unit process.
- 5.- Realization of different experiments, in automatic way, without having in front the particular unit. (These experiments can be decided previously).
- 6.- Simulation of outside actions, in the cases do not exist hardware elements. (Example: test of complementary tanks, complementary industrial environment to the process to be studied, etc).
- 7.- PLC hardware general use.
- 8.- PLC process application for the particular unit.
- 9.- PLC structure.
- 10.- PLC inputs and outputs configuration.
- 11.- PLC configuration possibilities.
- 12.- PLC program languages.
- 13.- PLC different programming standard languages (ladder diagram (LD), structured text (ST), instructions list (IL), sequential function chart (SFC), function block diagram (FBD)).
- 14.- New configuration and development of new process.
- 15.- Hand on an established process.
- 16.- To visualize and see the results and to make comparisons with the particular unit process.
- 17.- Possibility of creating new process in relation with the particular unit.
- 18.- PLC Programming Exercises.
- 19.- Own PLC applications in accordance with teacher and student requirements.

### b) Technical and Vocational Education configuration

#### ⑧ **THAR22C/ICAI. Interactive Computer Aided Instruction Software System.**

This complete software package consists of an Instructor Software (EDIBON Classroom Manager - ECM-SOF) totally integrated with the Student Software (EDIBON Student Labsoft - ESL-SOF). Both are interconnected so that the teacher knows at any moment what is the theoretical and practical knowledge of the students.

- ECM-SOF. EDIBON Classroom Manager (Instructor Software).

ECM-SOF is the application that allows the Instructor to register students, manage and assign tasks for workgroups, create own content to carry out Practical Exercises, choose one of the evaluation methods to check the Student knowledge and monitor the progression related to the planned tasks for individual students, workgroups, units, etc...so the teacher can know in real time the level of understanding of any student in the classroom.

Innovative features:

- User Data Base Management.
  - Administration and assignment of Workgroup, Task and Training sessions.
  - Creation and Integration of Practical Exercises and Multimedia Resources.
  - Custom Design of Evaluation Methods.
  - Creation and assignment of Formulas & Equations.
  - Equation System Solver Engine.
  - Updatable Contents.
  - Report generation, User Progression Monitoring and Statistics.
- ESL-SOF. EDIBON Student Labsoft (Student Software).

ESL-SOF is the application addressed to the Students that helps them to understand theoretical concepts by means of practical exercises and to prove their knowledge and progression by performing tests and calculations in addition to Multimedia Resources. Default planned tasks and an Open workgroup are provided by EDIBON to allow the students start working from the first session. Reports and statistics are available to know their progression at any time, as well as explanations for every exercise to reinforce the theoretically acquired technical knowledge.

Innovative features:

- Student Log-In & Self-Registration.
- Existing Tasks checking & Monitoring.
- Default contents & scheduled tasks available to be used from the first session.
- Practical Exercises accomplishment by following the Manual provided by EDIBON.
- Evaluation Methods to prove your knowledge and progression.
- Test self-correction.
- Calculations computing and plotting.
- Equation System Solver Engine.
- User Monitoring Learning & Printable Reports.
- Multimedia-Supported auxiliary resources.

⑨ **THAR22C/FSS. Faults Simulation System.**

Faults Simulation System (FSS) is a Software package that simulates several faults in any EDIBON Computer Controlled Unit. The "FAULTS" mode consists in causing several faults in the unit normal operation. The student must find them and solve them. There are several kinds of faults that can be grouped in the following sections:

Faults affecting the sensors measurement:

- An incorrect calibration is applied to them.
- Non-linearity.

Faults affecting the actuators:

- Actuators channels interchange at any time during the program execution.
- Response reduction of an actuator.

Faults in the controls execution:

- Inversion of the performance in ON/OFF controls.
- Reduction or increase of the calculated total response.
- The action of some controls is annulled.

On/off faults:

- Several on/off faults can be included.

c) Multipost Expansions options

⑩ **MINI ESN. EDIBON Mini Scada-Net System for being used with EDIBON Teaching Units.**

MINI ESN. EDIBON Mini Scada-Net System allows up to 30 students to work with a Teaching Unit in any laboratory, simultaneously.

The MINI ESN system consists of the adaptation of any EDIBON Computer Controlled Unit with SCADA integrated in a local network.

This system allows to view/control the unit remotely, from any computer integrated in the local net (in the classroom), through the main computer connected to the unit.

Main characteristics:

- It allows up to 30 students to work simultaneously with the EDIBON Computer Controlled Unit with SCADA, connected in a local net.
- Open Control + Multicontrol + Real Time Control + Multi Student Post.
- Instructor controls and explains to all students at the same time.
- Any user/student can work doing "real time" control/multicontrol and visualisation.
- Instructor can see in the computer what any user/student is doing in the unit.
- Continuous communication between the instructor and all the users/students connected.

Main advantages:

- It allows an easier and quicker understanding.
- This system allows you can save time and cost.
- Future expansions with more EDIBON Units.

The system basically will consist of:

This system is used with a Computer Controlled Unit.

- Instructor's computer.
- Students' computers.
- Local Network.
- Unit-Control Interface adaptation.
- Unit Software adaptation.
- Webcam.
- MINI ESN Software to control the whole system.
- Cables and accessories required for a normal operation.

\* Specifications subject to change without previous notice, due to the convenience of improvement of the product.



C/ Del Agua, 14. Polígono Industrial San José de Valderas.  
28918 LEGANÉS. (Madrid). ESPAÑA - SPAIN.  
Tel.: 34-91-6199363 Fax: 34-91-6198647

E-mail: [edibon@edibon.com](mailto:edibon@edibon.com) Web: [www.edibon.com](http://www.edibon.com)

Edition: ED01/18  
Date: January/2018

REPRESENTATIVE: