

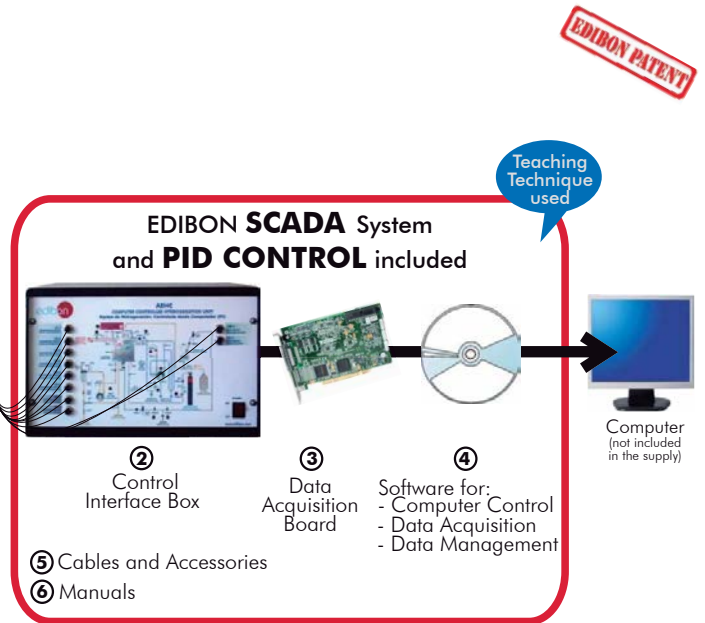

① Unit: AEHC. Hydrogenation Unit



\*Minimum supply always includes: 1 + 2 + 3 + 4 + 5 + 6  
(Computer not included in the supply)

Key features:

- **Advanced Real-Time SCADA and PID Control.**
- **Open Control + Multicontrol + Real-Time Control.**
- **Specialized EDIBON Control Software based on Labview.**
- **National Instruments Data Acquisition board (250 KS/s , kilo samples per second).**
- **Calibration exercises, which are included, teach the user how to calibrate a sensor and the importance of checking the accuracy of the sensors before taking measurements.**
- **Projector and/or electronic whiteboard compatibility allows the unit to be explained and demonstrated to an entire class at one time.**
- **Capable of doing applied research, real industrial simulation, training courses, etc.**
- **Remote operation and control by the user and remote control for EDIBON technical support, are always included.**
- **Totally safe, utilizing 4 safety systems (Mechanical, Electrical, Electronic & Software).**
- **Designed and manufactured under several quality standards.**
- **Optional CAL software helps the user perform calculations and comprehend the results.**
- **This unit has been designed for future expansion and integration. A common expansion is the EDIBON Scada-Net (ESN) System which enables multiple students to simultaneously operate many units in a network.**

**OPEN CONTROL  
+  
MULTICONTROL  
+  
REAL TIME CONTROL**

**www.edibon.com**  
 ↳ Products  
 ↳ Products range  
 ↳ Units  
 ↳ 12.-Food and Water Technologies

For more information about Key Features, click here:



ISO 9000: Quality Management  
(for Design, Manufacturing,  
Commercialization and After-sales service)



European Union Certificate  
(total safety)



Certificates ISO 14000 and  
ECO-Management and Audit Scheme  
(environmental management)



Worlddidac Quality Charter  
Certificate  
(Worlddidac Member)

## GENERAL DESCRIPTION

This Hydrogenation Unit is a batch processing vessel, which is used to adjust the degree of saturation of 22 l. batches of edible oils. It is easy and safe to use.

The AEHC unit for oil hydrogenation has the following main elements:

- Catalyst tank: where the catalyst is mixed with oil.
- Catalyst tank agitator: to mix the catalyst and the oil.
- Reactor (Hydrogenation vessel): tank where the three elements are mixed (oil, hydrogen and catalyst) and the reaction takes place.
- Reactor agitator: to promote hydrogenation.
- Hydrogen diffuser: for introducing hydrogen into the reactor.
- Heating coil: through which steam at high temperature circulates in order to heat up the oil until the reaction starts.
- Cooling coil: through which water circulates in order to limit the heating of the exothermic reaction.
- Vacuum pump: pump for vacuum creation inside the reactor.
- Oil pump (filter pump): pump to extract oil from the reactor and take it to the filter.
- Filter: tank where the hydrogenated oil is filtered to recover the catalyst.
- Visors, filters, regulators, ball valves, solenoid valves, non-return valve, security valve, rupture disc, hydrogen detector, manometers, temperature, pressure, level and flow sensors.

This Computer Controlled Unit is supplied with the EDIBON Computer Control System (SCADA), and includes: The unit itself + a Control Interface Box + a Data Acquisition Board + Computer Control and Data Acquisition Software Packages, for controlling the process and all parameters involved in the process.

## PROCESS DIAGRAM AND UNIT ELEMENTS ALLOCATION

**OPEN CONTROL**  
+  
**MULTICONTROL**  
+  
**REAL TIME CONTROL**

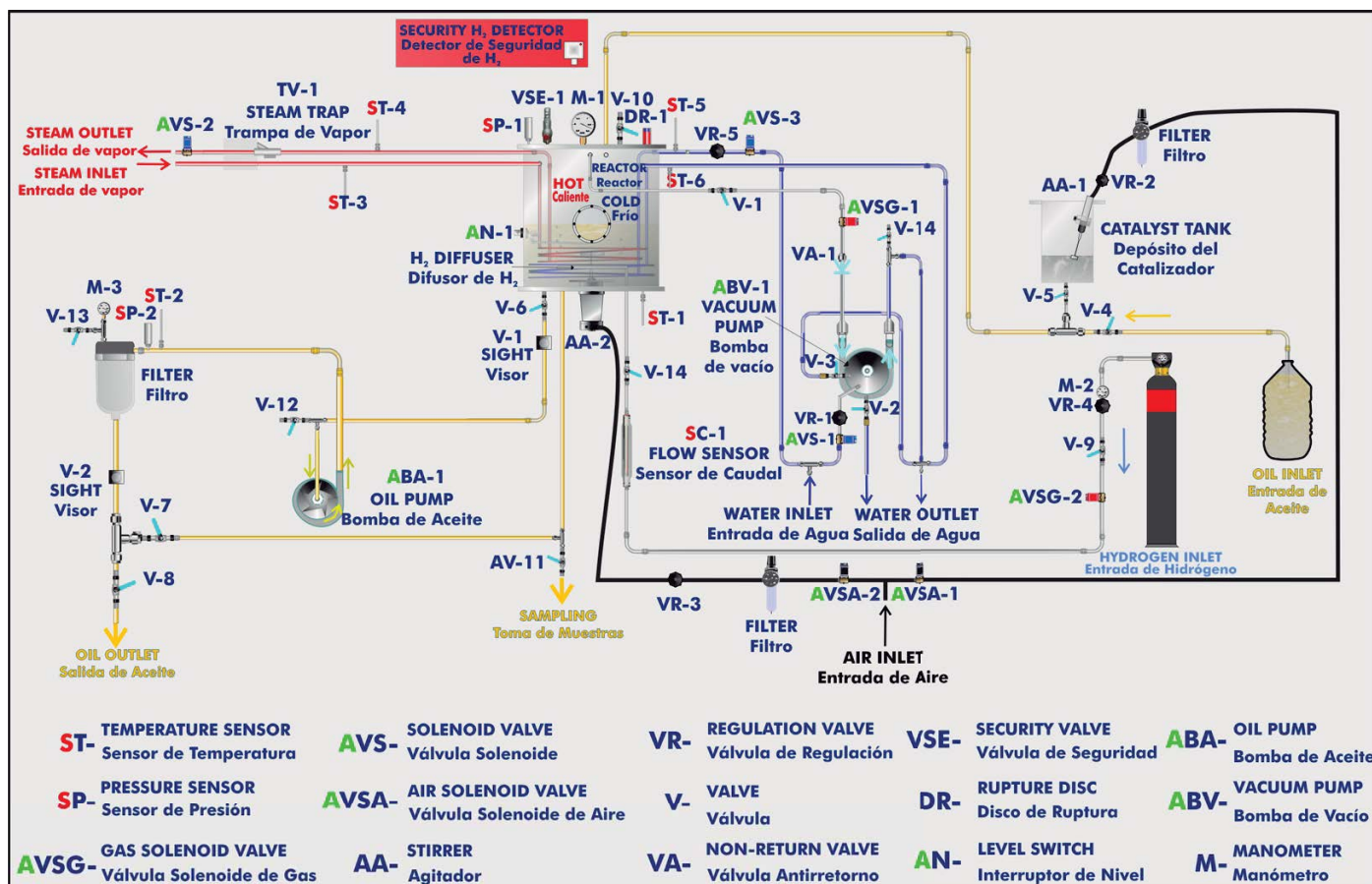

With this unit there are several options and possibilities:

- Main items: 1, 2, 3, 4, 5 and 6.
- Optional items: 7, 8, 9, 10, 11 and 12.

Let us describe first the main items (1 to 6):

**① AEHC. Unit:**

Anodized aluminium structure and panels in painted steel.  
 Main metallic elements in stainless steel.  
 Diagram in the front panel with similar distribution to the elements in the real unit.  
 All equipment in contact with the process fluid in stainless steel.

Stainless steel hydrogenation vessel (reactor):

- Total volume: 30 litres.
- Working volume: 22 litres.
- Minimum working volume: 14 litres.
- Heating coil.
- Cooling coil.
- Maximum pressure: 6.3 bar. Maximum working pressure: 3 bar.
- Stainless steel hydrogen diffuser.
- Level switch.
- Two visors.

- Stainless steel exhaust valve rated at 4 bar of pressure.
- Stainless steel rupture disc rated at 6.3 bar of pressure.

Variable speed agitator for the hydrogenation vessel:

- Pneumatic agitator.

Stainless steel catalyst tank:

- Volume: 6.5 litres.

Variable speed agitator for the catalyst tank:

- Pneumatic agitator.

Liquid ring vacuum pump:

- It enables the suction of gases even in the presence of liquids.
- Gas isothermic compression.
- Gases are never in contact with lubricants.
- Dry flow: 65m<sup>3</sup>/h. Wet flow: 87 m<sup>3</sup>/h.
- Absolute pressure reached: 0.6 bar.

Oil pump, centrifugal type:

- Flow (Q) = 100 l./min.
- Maximum pressure: 2.75 bar.
- Working temperature: 150-160°C.

Filter.

Security H<sub>2</sub> detector.

Sensors:

- 6 Temperature sensors.
- 2 Pressure sensors.
- Flow sensor.

3 Manometers.

Gas, water and air solenoid valves. Security valves.

Flameproof electrical equipment. Safe zone controls. Accurate control of hydrogen addition.

For the design of this unit, security has been especially taken into account, thus, it contains a hydrogen detector. In case of leak, the whole process is stopped and the input of hydrogen is cut off, the security valve is rated at 4 bar and the rupture disc at 6 bar.

This unit incorporates wheels for its mobility.

The complete unit includes as well:

**Advanced Real-Time SCADA and PID Control.**

**Open Control + Multicontrol + Real-Time Control.**

**Specialized EDIBON Control Software based on Labview.**

**National Instruments Data Acquisition board (250 KS/s , kilo samples per second).**

**Calibration exercises, which are included, teach the user how to calibrate a sensor and the importance of checking the accuracy of the sensors before taking measurements.**

**Projector and/or electronic whiteboard compatibility allows the unit to be explained and demonstrated to an entire class at one time.**

**Capable of doing applied research, real industrial simulation, training courses, etc.**

**Remote operation and control by the user and remote control for EDIBON technical support, are always included.**

**Totally safe, utilizing 4 safety systems (Mechanical, Electrical, Electronic & Software).**

**Designed and manufactured under several quality standards.**

**Optional CAL software helps the user perform calculations and comprehend the results.**

**This unit has been designed for future expansion and integration. A common expansion is the EDIBON Scada-Net (ESN) System which enables multiple students to simultaneously operate many units in a network.**



② **AEHC/CIB. Control Interface Box:**

The Control Interface Box is part of the SCADA system.

**Control interface box with process diagram in the front panel** and with the same distribution that the different elements located in the unit, for an easy understanding by the student.

All sensors, with their respective signals, are properly manipulated from -10V. to +10V. computer output. Sensors connectors in the interface have different pines numbers (from 2 to 16), to avoid connection errors. Single cable between the control interface box and computer.

**The unit control elements are permanently computer controlled**, without necessity of changes or connections during the whole process test procedure.

**Simultaneous visualization in the computer of all parameters involved in the process.**

**Calibration of all sensors involved in the process.**

**Real time curves representation about system responses.**

Storage of all the process data and results in a file.

Graphic representation, in real time, of all the process/system responses.

**All the actuators' values can be changed at any time from the keyboard** allowing the analysis about curves and responses of the whole process.

All the actuators and sensors values and their responses are displayed on only one screen in the computer.

**Shield and filtered signals to avoid external interferences.**

**Real time PID control with flexibility of modifications from the computer keyboard of the PID parameters, at any moment during the process.**

Real time PID and on/off control for pumps, compressors, resistances, control valves, etc.

**Real time PID control for parameters involved in the process simultaneously.**

**Proportional control, integral control and derivative control, based on the real PID mathematical formula, by changing the values, at any time**, of the three control constants (proportional, integral and derivative constants).

**Open control** allowing modifications, at any moment and in real time, of parameters involved in the process simultaneously.

Possibility of automatization of the actuators involved in the process.

**Three safety levels, one mechanical in the unit, another electronic in the control interface and the third one in the control software.**



AEHC/CIB

③ **DAB. Data Acquisition Board:**

The Data Acquisition board is part of the SCADA system.

PCI Data acquisition board (National Instruments) to be placed in a computer slot. Bus PCI.

**Analog input:**

Number of channels= 16 single-ended or 8 differential. Resolution= 16 bits, 1 in 65536.

**Sampling rate up to: 250 KS/s (kilo samples per second).**

Input range (V) = ±10 V. Data transfers=DMA, interrupts, programmed I/O. DMA channels=6.

**Analog output:**

Number of channels=2. Resolution= 16 bits, 1 in 65536. Maximum output rate up to: 833 KS/s.

Output range(V) = ±10 V. Data transfers=DMA, interrupts, programmed I/O.

**Digital Input/Output:**

Number of channels=24 inputs/outputs. D0 or DI Sample Clock frequency: 0 to 1 MHz.

Timing: Number of Counter/timers=2. Resolution: Counter/timers: 32 bits.



DAB

④ **AEHC/CCSOF. PID Computer Control + Data Acquisition+ Data Management Software:**

The three softwares are part of the SCADA system.

Compatible with actual Windows operating systems. Graphic and intuitive simulation of the process in screen. **Compatible with the industry standards.**

Registration and visualization of all process variables in an automatic and simultaneous way.

**Flexible, open and multicontrol software**, developed with actual windows graphic systems, acting simultaneously on all process parameters.

**Analog and digital PID control.**

**PID menu and set point selection required in the whole work range.**

**Management, processing, comparison and storage of data.**

**Sampling velocity up to 250 KS/s (kilo samples per second).**

**Calibration system for the sensors involved in the process.**

**It allows the registration of the alarms state and the graphic representation in real time.**

Comparative analysis of the obtained data, after the process and modification of the conditions during the process.

**Open software, allowing the teacher to modify texts, instructions. Teacher's and student's passwords** to facilitate the teacher's control on the student, and allowing the access to different work levels.

**This unit allows the 30 students of the classroom to visualize simultaneously all the results and the manipulation of the unit, during the process, by using a projector or an electronic whiteboard.**



AEHC/CCSOF

⑤ **Cables and Accessories**, for normal operation.

⑥ **Manuals:** This unit is **supplied with 8 manuals:** Required Services, Assembly and Installation, Interface and Control Software, Starting-up, Safety, Maintenance, Calibration & Practices Manuals.

\* References 1 to 6 are the main items: AEHC + AEHC/CIB + DAB + AEHC/CCSOF + Cables and Accessories + Manuals are included in the minimum supply for enabling normal and full operation.

## EXERCISES AND PRACTICAL POSSIBILITIES TO BE DONE WITH MAIN ITEMS

Some exercises and practical possibilities:

- 1.- Study of the effect of process temperature.
- 2.- Study of the effect of degree of agitation.
- 3.- Study of the effect of hydrogen gas pressure.
- 4.- Operation of small scale version of the industrial hydrogenation process.
- 5.- To determine the optimum catalyst dosage.
- 6.- To demonstrate the operation of the filter for catalyst recovery.
- 7.- Study of the effect of catalyst type.

Additional practical possibilities:

- 8.- Sensors calibration.

Other possibilities to be done with this Unit:

- 9.- Many students view results simultaneously.

To view all results in real time in the classroom by means of a projector or an electronic whiteboard.

- 10.- Open Control, Multicontrol and Real Time Control.

This unit allows intrinsically and/or extrinsically to change the span, gains; proportional, integral, derivative parameters; etc, in real time.

- 11.-The Computer Control System with SCADA and PID Control allow a real industrial simulation.
- 12.-This unit is totally safe as uses mechanical, electrical and electronic, and software safety devices.
- 13.- This unit can be used for doing applied research.
- 14.-This unit can be used for giving training courses to Industries even to other Technical Education Institutions.
- 15.-Control of the AEHC unit process through the control interface box without the computer.
- 16.-Visualization of all the sensors values used in the AEHC unit process.  
- By using PLC-PI additional 19 more exercises can be done.  
- Several other exercises can be done and designed by the user.

### REQUIRED SERVICES

- Electrical supply: three-phase, 380V./50Hz or 220V./60Hz.
- Steam supply (EDIBON Steam generator (TGV/6KW) or similar generator).
- Compressed air.
- Cooling water.
- Computer (PC).

### DIMENSIONS & WEIGHTS

AEHC:

- |                        |  |
|------------------------|--|
| Unit:                  | -Dimensions:1400 x 1100 x 2000 mm. approx.<br>(55.11 x 43.30 x 78.74 inches approx.) |
|                        | -Weight: 360 Kg. approx.<br>(793 pounds approx.).                                    |
| Control Interface Box: | -Dimensions:490 x 330 x 310 mm. approx.<br>(19.29 x 12.99 x 12.20 inches approx.).   |
|                        | -Weight: 10 Kg. approx.<br>(22 pounds approx.).                                      |

### REQUIRED ANCILLARY EQUIPMENT

- Hydrogenation gas cylinder of 99.75 % purity or better.

SCADA and PID Control

Main screen

I Main software operation possibilities.

II Sensors displays, real time values, and extra output parameters. Sensors: ST=Temperature sensor. SP=Pressure sensor. SC=Flow sensor. AN=Level switch.

III Actuators controls. Actuators: ABV=Vacuum pump. ABA=Oil pump (filter pump). AVS=Solenoid valve. AVSG=Gas solenoid valve. AVSA=Air solenoid valve.

IV Channel selection and other plot parameters.

V Real time graphics displays.

Software for Sensors Calibration

Sensors	Volts	Calibrated	Err (%)
ST-1	0,2046	22,3821	0,82
ST-2	0,2292	23,483	0,28
ST-3	0,2353	23,1522	0,05
ST-4	0,2301	23,2113	0,01
	0,1527	13,1629	10,04
SCC-1	-5,2792	172,5164	149,31
	-0,2362	-22,6609	45,87
SC-1	-0,1774	0,0319629	23,17
	-0,2681	-60,4623	83,67
	-0,2251	0,4208	22,78
	-0,2529	-0,2529	23,46
	-0,2063	-0,1178	23,32
	-0,2581	-226,9384	250,14
	-0,3634	-0,3634	23,57
	-0,275	-0,275	23,48
	-0,2005	-0,2005	23,41

By using a free of charge code, the teacher and the students can calibrate the unit.

The teacher can recover his/her own calibration by using the EDIBON code that we give free of charge.

## COMPLETE TECHNICAL SPECIFICATIONS (for optional items)

Additionally to the main items (1 to 6) described, we can offer, as optional, other items from 7 to 12.

All these items try to give more possibilities for:

- a) Industrial configuration. (PLC)
- b) Technical and Vocational Education configuration. (CAI and FSS)
- c) Higher Education and/or Technical and Vocational Education configuration. (CAI)
- d) Multipost Expansions options. (Mini ESN and ESN)

### a) Industrial configuration

#### ⑦ **PLC. Industrial Control using PLC** (it includes PLC-PI Module plus PLC-SOF Control Software):

##### **-PLC-PI. PLC Module:**

**Metallic box.**

**Circuit diagram in the module front panel.**

**Front panel:**

##### **Digital inputs(X) and Digital outputs (Y) block:**

**16 Digital inputs**, activated by switches and 16 LEDs for confirmation (red).

**14 Digital outputs** (through SCSI connector) with 14 LEDs for message (green).

##### **Analog inputs block:**

**16 Analog inputs** (-10 V. to + 10 V.) (through SCSI connector).

##### **Analog outputs block:**

**4 Analog outputs** (-10 V. to + 10 V.) (through SCSI connector).

##### **Touch screen:**

High visibility and multiple functions. Display of a highly visible status. Recipe function. Bar graph function. Flow display function. Alarm list.

Multi language function. True type fonts.

**Back panel:**

Power supply connector. Fuse 2A. RS-232 connector to PC. USB 2.0 connector to PC.

**Inside:**

Power supply outputs: 24 Vdc, 12 Vdc, -12 Vdc, 12 Vdc variable.

##### **Panasonic PLC:**

**High-speed scan of 0.32 µsec.** for a basic instruction.

**Program capacity of 32 Ksteps**, with a sufficient comment area.

Power supply input (100 to 240 V AC).

DC input: 16 (24 V DC).

Relay output: 14.

**High-speed counter.**

**Multi-point PID control.**

**Digital inputs/outputs and analog inputs/outputs Panasonic modules.**

Communication RS232 wire to computer (PC).

Dimensions: 490 x 330 x 310 mm. approx. Weight: 30 Kg. approx.

##### **-AEHC/PLC-SOF. PLC Control Software:**

**For this particular unit, always included with PLC supply.**

The software has been designed using Labview and it follows the unit operation procedure and linked with the Control Interface Box used in the Computer Controlled Hydrogenation Unit (AEHC).

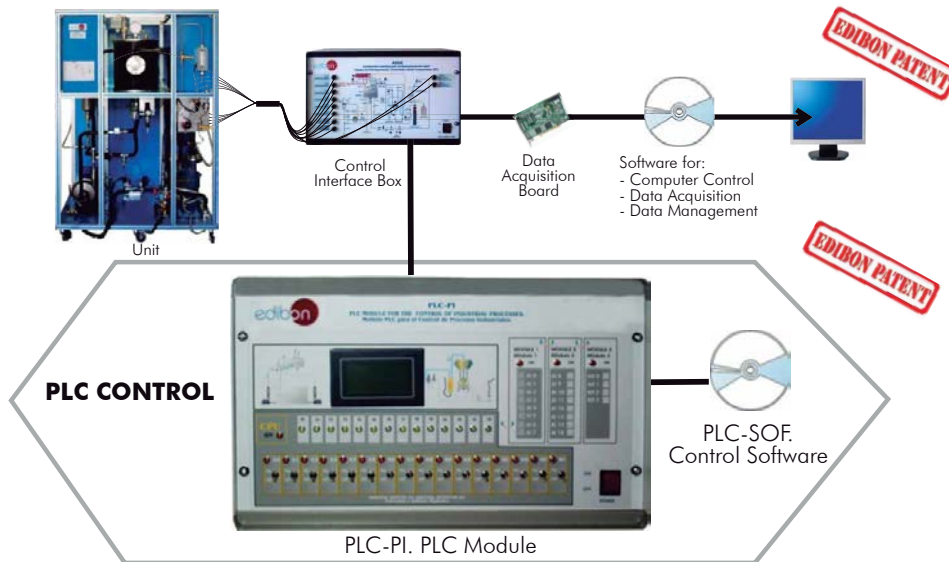

#### **Practices to be done with PLC-PI:**

- |   |  |
|---|--|
| <ul style="list-style-type: none"> <li>1.- Control of the AEHC unit process through the control interface box without the computer.</li> <li>2.- Visualization of all the sensors values used in the AEHC unit process.</li> <li>3.- Calibration of all sensors included in the AEHC unit process.</li> <li>4.- Hand on of all the actuators involved in the AEHC unit process.</li> <li>5.- Realization of different experiments, in automatic way, without having in front the unit. (This experiment can be decided previously).</li> <li>6.- Simulation of outside actions, in the cases hardware elements do not exist. (Example: test of complementary tanks, complementary industrial environment to the process to be studied, etc).</li> <li>7.- PLC hardware general use and manipulation.</li> <li>8.- PLC process application for AEHC unit.</li> <li>9.- PLC structure.</li> </ul> | <ul style="list-style-type: none"> <li>10.- PLC inputs and outputs configuration.</li> <li>11.- PLC configuration possibilities.</li> <li>12.- PLC programming languages.</li> <li>13.- PLC different programming standard languages.</li> <li>14.- New configuration and development of new process.</li> <li>15.- Hand on an established process.</li> <li>16.- To visualize and see the results and to make comparisons with the AEHC unit process.</li> <li>17.- Possibility of creating new process in relation with the AEHC unit.</li> <li>18.- PLC Programming exercises.</li> <li>19.- Own PLC applications in accordance with teacher and student requirements.</li> </ul> |
|---|--|

b) Technical and Vocational Education configuration

⑥ **AEHC/CAI. Computer Aided Instruction Software System.**

This complete package included two Softwares: the INS/SOF. Classroom Management Software (Instructor Software) and the AEHC/SOF. Computer Aided Instruction Software (Student Software).

This software is optional and can be used additionally to items (1 to 6).

This complete package consists on an Instructor Software (INS/SOF) totally integrated with the Student Software (AEHC/SOF). Both are interconnected so that the teacher knows at any moment what is the theoretical and practical knowledge of the students. These, on the other hand, get a virtual instructor who helps them to deal with all the information on the subject of study.

- INS/SOF. Classroom Management Software (Instructor Software):

The Instructor can:

- Organize Students by Classes and Groups.
- Create easily new entries or delete them.
- Create data bases with student information.
- Analyze results and make statistical comparisons.
- Print reports.
- Develop own examinations.
- Detect student's progress and difficulties.
- ...and many other facilities.

**Instructor Software**

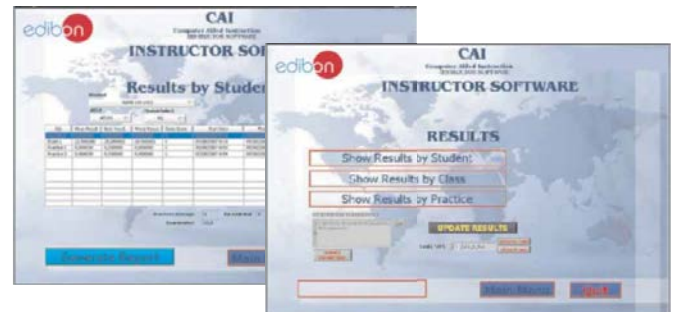

- AEHC/SOF. Computer Aided Instruction Software (Student Software):

It explains how to use the unit, run the experiments and what to do at any moment.

This Software contains:

- Theory.
- Exercises.
- Guided Practices.
- Exams.

**Student Software**



For more information see CAI catalogue. Click on the following link:

[www.edibon.com/products/catalogues/en/CAI.pdf](http://www.edibon.com/products/catalogues/en/CAI.pdf)

⑥ **AEHC/FSS. Faults Simulation System.**

Faults Simulation System (FSS) is a Software package that simulates several faults in any EDIBON Computer Controlled Unit. It is useful for Technical and Vocational level.

The "FAULTS" mode consists on causing several faults in the unit normal operation. The student must find them and solve them.

There are several kinds of faults that can be grouped in the following sections:

Faults affecting the sensors measurement:

- An incorrect calibration is applied to them.
- Non-linearity.

Faults affecting the actuators:

- Actuators channels interchange at any time during the program execution.
- Response reduction of an actuator.

Faults in the controls execution:

- Inversion of the performance in ON/OFF controls.
- Reduction or increase of the calculated total response.
- The action of some controls is annulled.

On/off faults:

- Several on/off faults can be included.

Example of some screens

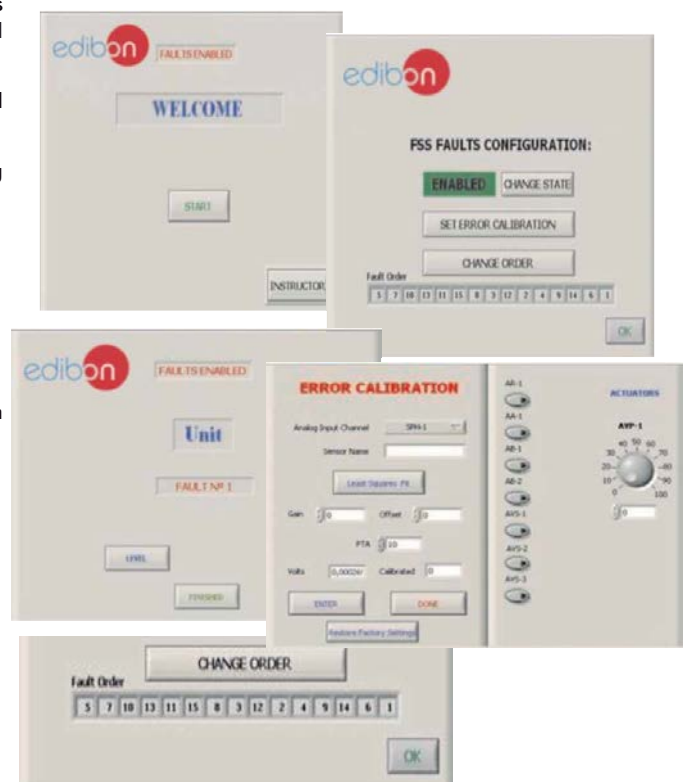

For more information see FSS catalogue. Click on the following link:

[www.edibon.com/products/catalogues/en/FSS.pdf](http://www.edibon.com/products/catalogues/en/FSS.pdf)



c) Higher Education and/or Technical and Vocational Education configuration

⑩ **AEHC/CAL. Computer Aided Learning Software (Results Calculation and Analysis).**

This Computer Aided Learning Software (CAL) is a Windows based software, simple and very easy to use, specifically developed by EDIBON. It is very useful for Higher Education level.

CAL is a class assistant that helps in making the necessary calculations to extract the right conclusions from data obtained during the experimental practices.

CAL will perform the calculations.

CAL computes the value of all the variables involved.

It allows to plot and print the results. Between the plotting options, any variable can be represented against any other.

Different plotting displays.

It has a wide range of information, such as constant values, unit conversion factors and integral and derivative tables.

For more information see CAL catalogue. Click on the following link:

[www.edibon.com/products/catalogues/en/CAL.pdf](http://www.edibon.com/products/catalogues/en/CAL.pdf)

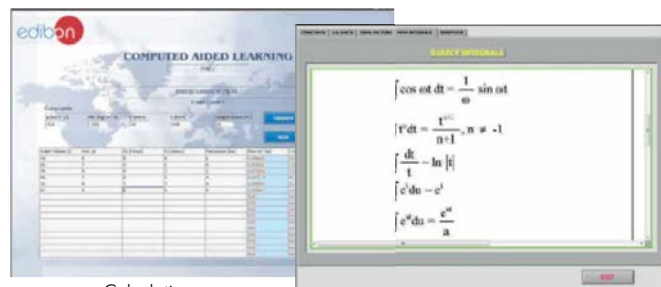

Calculations

Information of constant values, unit conversion factors and integral and derivative tables



Plotting options

d) Multipost Expansions options

⑪ **Mini ESN. EDIBON Mini Scada-Net System.**

Mini ESN. EDIBON Mini Scada-Net System allows up to 30 students to work with a Teaching Unit in any laboratory, simultaneously. It is useful for both, Higher Education and/or Technical and Vocational Education.

The Mini ESN system consists on the adaptation of any EDIBON Computer Controlled Unit with SCADA and PID Control integrated in a local network.

This system allows to view/control the unit remotely, from any computer integrated in the local net (in the classroom), through the main computer connected to the unit. Then, the number of possible users who can work with the same unit is higher than in an usual way of working (usually only one).

Main characteristics:

- It allows up to 30 students to work simultaneously with the EDIBON Computer Controlled Unit with SCADA and PID Control, connected in a local net.
- Open Control + Multicontrol + Real Time Control + Multi Student Post.
- Instructor controls and explains to all students at the same time.
- Any user/student can work doing "real time" control/multicontrol and visualisation.
- Instructor can see in the computer what any user/student is doing in the unit.
- Continuous communication between the instructor and all the users/students connected.

Main advantages:

- It allows an easier and quicker understanding.
- This system allows you can save time and cost.
- Future expansions with more EDIBON Units.

For more information see Mini ESN catalogue. Click on the following link:

[www.edibon.com/products/catalogues/en/Mini-ESN.pdf](http://www.edibon.com/products/catalogues/en/Mini-ESN.pdf)

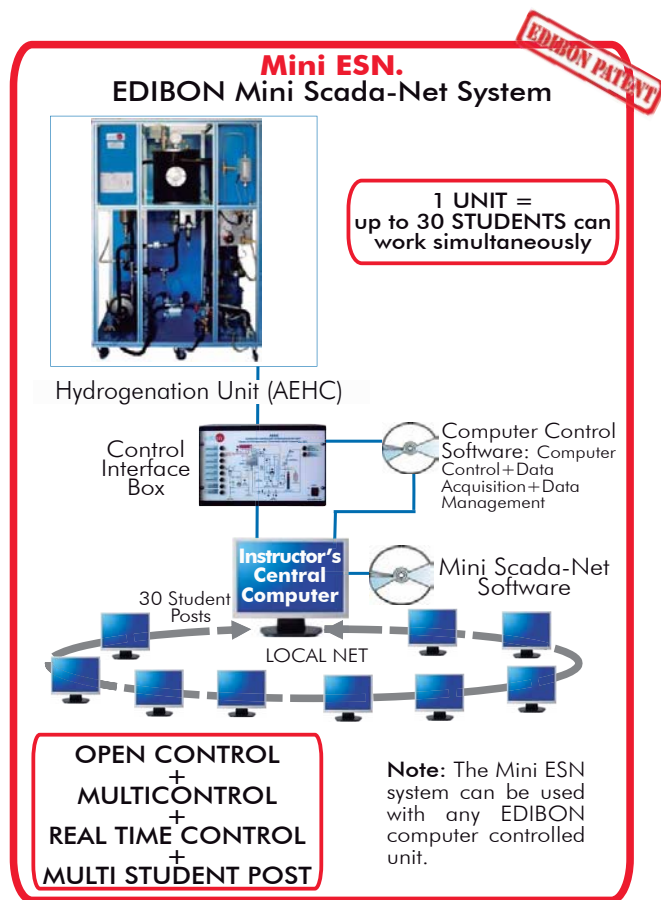

⑫ **ESN. EDIBON Scada-Net System.**

This unit can be integrated, in future, in a Complete Laboratory with many Units and many Students.

For more information see ESN catalogue. Click on the following link:

[www.edibon.com/products/catalogues/en/units/foodwatertechnologies/esn-foodtechnology/ESN-FOOD\\_TECHNOLOGY.pdf](http://www.edibon.com/products/catalogues/en/units/foodwatertechnologies/esn-foodtechnology/ESN-FOOD_TECHNOLOGY.pdf)

## ORDER INFORMATION

### **Main items** (always included in the supply)

Minimum supply always includes:

- ① **Unit: AEHC. Hydrogenation Unit.**
- ② **AEHC/CIB. Control Interface Box.**
- ③ **DAB. Data Acquisition Board.**
- ④ **AEHC/CCSOF. PID Computer Control + Data Acquisition + Data Management Software.**
- ⑤ **Cables and Accessories**, for normal operation.
- ⑥ **Manuals.**

\* **IMPORTANT:** Under **AEHC** we always supply all the elements for immediate running as 1, 2, 3, 4, 5 and 6.

### **Optional items** (supplied under specific order)

#### a) Industrial configuration

- ⑦ PLC. Industrial Control using PLC (it includes PLC-PI Module plus PLC-SOF Control Software):
  - PCL-PI. PLC Module.
  - AEHC/PLC-SOF. PLC Control Software.

#### b) Technical and Vocational configuration

- ⑧ AEHC/CAI. Computer Aided Instruction Software System.
- ⑨ AEHC/FSS. Faults Simulation System.

#### c) Higher Education and/or Technical and Vocational Education configuration

- ⑩ AEHC/CAL. Computer Aided Learning Software (Results Calculation and Analysis).

#### d) Multipost Expansions options

- ⑪ Mini ESN. EDIBON Mini Scada-Net System.
- ⑫ ESN. EDIBON Scada-Net System.

**① AEHC. Unit:**

Anodized aluminium structure and panels in painted steel.

Main metallic elements in stainless steel.

Diagram in the front panel with similar distribution to the elements in the real unit.

All equipment in contact with the process fluid in stainless steel.

Stainless steel hydrogenation vessel (reactor):

Total volume: 30 litres.

Working volume: 22 litres.

Minimum working volume: 14 litres.

Heating coil.

Cooling coil.

Maximum pressure: 6.3 bar. Maximum working pressure: 3 bar.

Stainless steel hydrogen diffuser.

Level switch.

Two visors.

Stainless steel exhaust valve rated at 4 bar of pressure.

Stainless steel rupture disc rated at 6.3 bar of pressure.

Variable speed agitator for the hydrogenation vessel:

Pneumatic agitator.

Stainless steel catalyst tank:

Volume: 6.5 litres.

Variable speed agitator for the catalyst tank:

Pneumatic agitator.

Liquid ring vacuum pump:

It enables the suction of gases even in the presence of liquids.

Gas isothermic compression.

Gases are never in contact with lubricants.

Dry flow: 65m<sup>3</sup>/h. Wet flow: 87 m<sup>3</sup>/h.

Absolute pressure reached: 0.6 bar.

Oil pump, centrifugal type:

Flow (Q)= 100 l./min.

Maximum pressure: 2.75 bar.

Working temperature: 150-160°C.

Filter.

Security H<sub>2</sub> detector.

Sensors:

6 Temperature sensors.

2 Pressure sensors.

Flow sensor.

3 Manometers.

Gas, water and air solenoid valves. Security valves.

Flameproof electrical equipment. Safe zone controls. Accurate control of hydrogen addition.

For the design of this unit, security has been especially taken into account, thus, it contains a hydrogen detector. In case of leak, the whole process is stopped and the input of hydrogen is cut off, the security valve is rated at 4 bar and the rupture disc at 6 bar.

This unit incorporates wheels for its mobility.

The complete unit includes as well:

Advanced Real-Time SCADA and PID Control.

Open Control + Multicontrol + Real-Time Control.

Specialized EDIBON Control Software based on Labview.

National Instruments Data Acquisition board (250 KS/s, kilo samples per second).

Calibration exercises, which are included, teach the user how to calibrate a sensor and the importance of checking the accuracy of the sensors before taking measurements.

Projector and/or electronic whiteboard compatibility allows the unit to be explained and demonstrated to an entire class at one time.

Capable of doing applied research, real industrial simulation, training courses, etc.

Remote operation and control by the user and remote control for EDIBON technical support, are always included.

Totally safe, utilizing 4 safety systems (Mechanical, Electrical, Electronic & Software).

Designed and manufactured under several quality standards.

Optional CAL software helps the user perform calculations and comprehend the results.

This unit has been designed for future expansion and integration. A common expansion is the EDIBON Scada-Net (ESN) System which enables multiple students to simultaneously operate many units in a network.

**② AEHC/CIB. Control Interface Box:**

The Control Interface Box is part of the SCADA system. Control interface box with process diagram in the front panel.

The unit control elements are permanently computer controlled.

Simultaneous visualization in the computer of all parameters involved in the process.

Calibration of all sensors involved in the process.

Real time curves representation about system responses.

All the actuators' values can be changed at any time from the keyboard allowing the analysis about curves and responses of the whole process.

Shield and filtered signals to avoid external interferences.

Real time PID control with flexibility of modifications from the computer keyboard of the PID parameters, at any moment during the process.

Real time PID control for parameters involved in the process simultaneously.

Proportional control, integral control and derivative control, based on the real PID mathematical formula, by changing the values, at any time, of the three control constants (proportional, integral and derivative constants).

Open control allowing modifications, at any moment and in real time, of parameters involved in the process simultaneously.

Three safety levels, one mechanical in the unit, another electronic in the control interface and the third one in the control software.

**③ DAB. Data Acquisition Board:**

The Data Acquisition board is part of the SCADA system.

PCI Data acquisition board (National Instruments) to be placed in a computer slot.

Analogue input: Channels= 16 single-ended or 8 differential. Resolution= 16 bits, 1 in 65536. Sampling rate up to: 250 KS/s (kilo samples per second).

Analogue output: Channels=2. Resolution=16 bits, 1 in 65536.

Digital Input/Output: Channels=24 inputs/outputs.

**④ AEHC/CSOF. PID Computer Control + Data Acquisition + Data Management Software:**

The three softwares are part of the SCADA system.

Compatible with the industry standards.

Flexible, open and multicontrol software, developed with actual windows graphic systems, acting simultaneously on all process parameters.

Analogue and digital PID control. PID menu and set point selection required in the whole work range.

Management, processing, comparison and storage of data.

Sampling velocity up to 250 KS/s (kilo samples per second).

Calibration system for the sensors involved in the process.

It allows the registration of the alarms state and the graphic representation in real time.

Open software, allowing the teacher to modify texts, instructions. Teacher's and student's passwords to facilitate the teacher's control on the student, and allowing the access to different work levels.

This unit allows the 30 students of the classroom to visualize simultaneously all the results and the manipulation of the unit, during the process, by using a projector or an electronic whiteboard.

**⑤ Cables and Accessories**, for normal operation.**⑥ Manuals:** This unit is supplied with 8 manuals: Required Services, Assembly and Installation, Interface and Control Software, Starting-up, Safety, Maintenance, Calibration & Practices Manuals.

**Exercises and Practical Possibilities to be done with Main Items**

- 1.- Study of the effect of process temperature.
- 2.- Study of the effect of degree of agitation.
- 3.- Study of the effect of hydrogen gas pressure.
- 4.- Operation of small scale version of the industrial hydrogenation process.
- 5.- To determine the optimum catalyst dosage.
- 6.- To demonstrate the operation of the filter for catalyst recovery.
- 7.- Study of the effect of catalyst type.

Additional practical possibilities:

- 8.- Sensors calibration.

Other possibilities to be done with this Unit:

- 9.- Many students view results simultaneously.

To view all results in real time in the classroom by means of a projector or an electronic whiteboard.

- 10.- Open Control, Multicontrol and Real Time Control.

This unit allows intrinsically and/or extrinsically to change the span, gains; proportional, integral, derivate parameters; etc, in real time.

- 11.- The Computer Control System with SCADA and PID Control allow a real industrial simulation.

- 12.- This unit is totally safe as uses mechanical, electrical and electronic, and software safety devices.

- 13.- This unit can be used for doing applied research.

- 14.- This unit can be used for giving training courses to Industries even to other Technical Education Institutions.

- 15.- Control of the AEHC unit process through the control interface box without the computer.

- 16.- Visualization of all the sensors values used in the AEHC unit process.

- By using PLC-PI additional 19 more exercises can be done.

- Several other exercises can be done and designed by the user.

a) Industrial configuration

⑦ **PLC. Industrial Control using PLC** (it includes PLC-PI Module plus PLC-SOF Control Software):

**-PLC-PI. PLC Module:**

Metallic box.  
 Circuit diagram in the module front panel.  
 Digital inputs(X) and Digital outputs (Y) block: 16 Digital inputs. 14 Digital outputs.  
 Analog inputs block: 16 Analog inputs.  
 Analog outputs block: 4 Analog outputs.  
 Touch screen.  
 Panasonic PLC:

High-speed scan of 0.32 µsec. Program capacity of 32 Ksteps. High-speed counter. Multi-point PID control.  
 Digital inputs/outputs and analog inputs/outputs Panasonic modules.

**-AEHC/PLC-SOF. PLC Control Software:**

For this particular unit, always included with PLC supply.

**Practices to be done with PLC-PI:**

- 1.- Control of the AEHC unit process through the control interface box without the computer.
- 2.- Visualization of all the sensors values used in the AEHC unit process.
- 3.- Calibration of all the sensors included in the AEHC unit process.
- 4.- Hand on of all the actuators involved in the AEHC unit process.
- 5.- Realization of different experiments, in automatic way, without having in front the unit. (This experiment can be decided previously).
- 6.- Simulation of outside actions, in the cases hardware elements do not exist. (Example: test of complementary tanks, complementary industrial environment to the process to be studied, etc).
- 7.- PLC hardware general use and manipulation.
- 8.- PLC process application for AEHC unit.
- 9.- PLC structure.
- 10.- PLC inputs and outputs configuration.
- 11.- PLC configuration possibilities.
- 12.- PLC programming languages.
- 13.- PLC different programming standard languages.
- 14.- New configuration and development of new process.
- 15.- Hand on an established process.
- 16.- To visualize and see the results and to make comparisons with the AEHC unit process.
- 17.- Possibility of creating new process in relation with the AEHC unit.
- 18.- PLC Programming exercises.
- 19.- Own PLC applications in accordance with teacher and student requirements.

b) Technical and Vocational Education configuration

⑧ **AEHC/CAI. Computer Aided Instruction Software System.**

This complete package consists on an Instructor Software (INS/SOF) totally integrated with the Student Software (AEHC/SOF).

-INS/SOF. Classroom Management Software (Instructor Software):

The Instructor can:

- Organize Students by Classes and Groups.
- Create easily new entries or delete them.
- Create data bases with student information.
- Analyze results and make statistical comparisons.
- Print reports.
- Develop own examinations.
- Detect student's progress and difficulties.

-AEHC/SOF. Computer Aided Instruction Software (Student Software):

It explains how to use the unit, run the experiments and what to do at any moment.

This Software contains:

- Theory.
- Exercises.
- Guided Practices.
- Exams.

⑨ **AEHC/FSS. Faults Simulation System.**

Faults Simulation System (FSS) is a Software package that simulates several faults in any EDIBON Computer Controlled Unit.

The "FAULTS" mode consists on causing several faults in the unit normal operation. The student must find them and solve them.

There are several kinds of faults that can be grouped in the following sections:

Faults affecting the sensors measurement:

- An incorrect calibration is applied to them.
- Non-linearity.

Faults affecting the actuators:

- Actuators channels interchange at any time during the program execution.
- Response reduction of an actuator.

Faults in the controls execution:

- Inversion of the performance in ON/OFF controls.
- Reduction or increase of the calculated total response.
- The action of some controls is annulled.

On/off faults:

- Several on/off faults can be included.

c) Higher Education and/or Technical and Vocational Education configuration

⑩ **AEHC/CAL. Computer Aided Learning Software (Results Calculation and Analysis).**

This Computer Aided Learning Software (CAL) is a Windows based software, simple and very easy to use.  
CAL is a class assistant that helps in making the necessary calculations to extract the right conclusions from data obtained during the experimental practices.  
CAL will perform the calculations.  
CAL computes the value of all the variables involved.  
It allows to plot and print the results. Between the plotting options, any variable can be represented against any other.  
Different plotting displays.  
It has a wide range of information, such as constant values, unit conversion factors and integral and derivative tables.

d) Multipost Expansions options

⑪ **Mini ESN. EDIBON Mini Scada-Net System.**

EDIBON Mini Scada-Net System allows up to 30 students to work with a Teaching Unit in any laboratory, simultaneously.  
The Mini ESN system consists on the adaptation of any EDIBON Computer Controlled Unit with SCADA and PID Control integrated in a local network.  
This system allows to view/control the unit remotely, from any computer integrated in the local net (in the classroom), through the main computer connected to the unit.

Main characteristics:

- It allows up to 30 students to work simultaneously with the EDIBON Computer Controlled Unit with SCADA and PID Control, connected in a local net.
- Open Control + Multicontrol + Real Time Control + Multi Student Post.
- Instructor controls and explains to all students at the same time.
- Any user/student can work doing "real time" control/multicontrol and visualisation.
- Instructor can see in the computer what any user/student is doing in the unit.
- Continuous communication between the instructor and all the users/students connected.

Main advantages:

- It allows an easier and quicker understanding.
- This system allows you can save time and cost.
- Future expansions with more EDIBON Units.

The system basically will consist of:

This system is used with a Computer Controlled Unit.

- Instructor's computer.
- Students' computers.
- Local Network.
- Unit- Control Interface adaptation.
- Unit Software adaptation.
- Webcam.
- Mini ESN Software to control the whole system.
- Cables and accessories required for a normal operation.

\*Specifications subject to change without previous notice, due to the convenience of improvements of the product.



C/ Del Agua, 14. Polígono Industrial San José de Valderas.  
28918 LEGANÉS. (Madrid). SPAIN.  
Phone: 34-91-6199363 FAX: 34-91-6198647  
E-mail: edibon@edibon.com WEB site: [www.edibon.com](http://www.edibon.com)

Issue: ED01/13  
Date: August/2013

REPRESENTATIVE: