

Available with PLC, as:
- PANASONIC
- SIEMENS
- MITSUBISHI
- ALLEN BRADLEY
- OMRON
Etc...

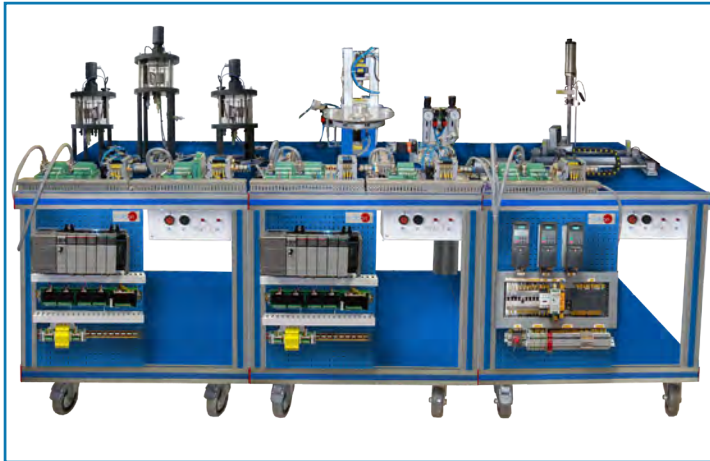

① Unit: AE-PLC-FMS14. Flexible Manufacturing System 14

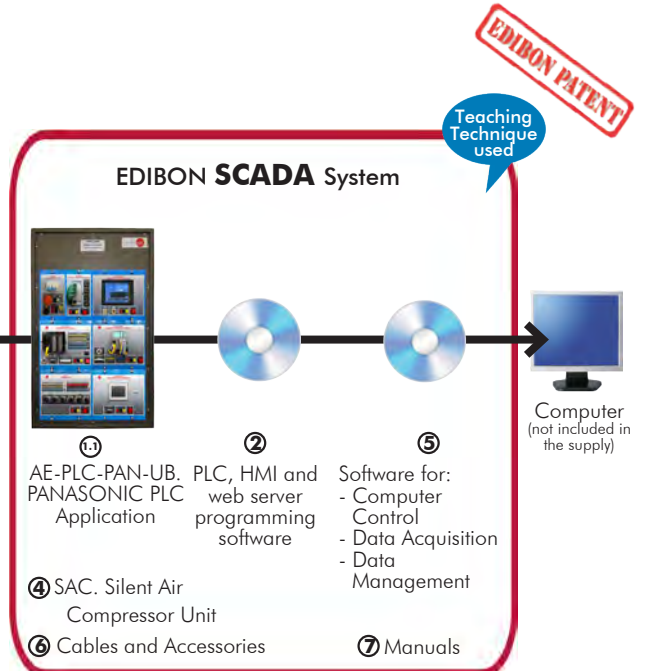

* Minimum supply always includes: 1 + 2 + 3 + 4 + 5 + 6 + 7 (Computer not included in the supply)

③ Component Workstations:

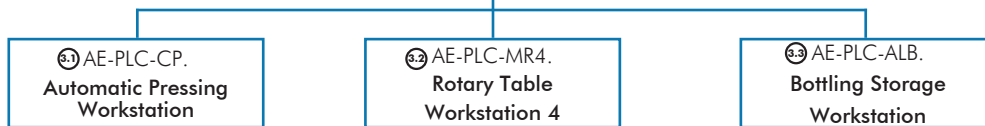

Key features:

- **Advanced Real-Time SCADA.**
- **Open Control + Multicontrol + Real-Time Control.**
- **Specialized EDIBON Control Software based on LabVIEW.**
- **PLC, HMI and web server programming software.**
- **Projector and/or electronic whiteboard compatibility allows the unit to be explained and demonstrated to an entire class at one time.**
- **Capable of doing applied research, real industrial simulation, training courses, etc.**
- **Remote operation and control by the user and remote control for EDIBON technical support, are always included.**
- **Totally safe, utilizing 4 safety systems (Mechanical, Electrical, Electronic & Software).**
- **Designed and manufactured under several quality standards.**
- **Optional software for the realization of 2D and 3D simulation, variables monitoring and SCADA control of the flexible manufacturing system.**
- **Optional ICAI software to create, edit and carry out practical exercises, tests, exams, calculations, etc. Apart from monitoring user's knowledge and progress reached.**
- **This unit has been designed for future expansion and integration. A common expansion is the EDIBON Scada-Net (ESN) System which enables multiple students to simultaneously operate many units in a network.**

OPEN CONTROL
+
MULTICONTROL
+
REAL TIME CONTROL

POWERED BY
RATIONAL INSTRUMENTS
LabVIEW™

www.edibon.com
PRODUCTS
➤ 60+ MECHATRONICS & COMPUTE MECHANICS

For more information about Key Features, click here



ISO 9001: Quality Management (for Design, Manufacturing, Commercialization and After-sales service)



European Union Certificate (total safety)



Certificates ISO 14001 and ECO-Management and Audit Scheme (environmental management)



Certificate and Worlddidac Member

INTRODUCTION

Since the 1950s, the computer integration in the manufacturing systems it has been a complete revolution, increasing productivity and quality of all type of products. These computer integration systems included a lot of component from very different technologies as hydraulic, pneumatic, electrical, robotics, chemical, etc. For this reason these types of systems requires workers with specific skills to ensure that they are working properly.

The Flexible Manufacturing System 14, "AE-PLC-FMS14", has been designed by EDIBON to study how a complete manufacturing system works.

The "AE-PLC-FMS14" system includes a set of practical exercises through which the student will understand how work an industrial control processes system, an automatic filling and bottling system and an automatic storing system.

GENERAL DESCRIPTION

The Flexible Manufacturing System 14, "AE-PLC-FMS14" is a modular system composed of three workstations: the Industrial Control Processes Workstation "AE-PLC-CP", the Rotary Table Workstation 4 "AE-PLC-MR4", the Bottling Storage Workstation and "AE-PLC-ALB".

The objective of the "AE-PLC-FMS14" system is to process the input water through the control of its temperature, level, pressure and flow in different stages. Once obtained the product, it is bottled and is storage.

The process of the "AE-PLC-FMS14" is explained in the following lines:

- First, the industrial control processes workstation controls the temperature, the level, the flow and the pressure through four industrial controllers in different stages. The output product is pumped to the next workstation.
- Then, the rotary table workstation get the product, and fill the bottles. The rotary table includes several positions that provide the bottles, the place where each bottle is filled and where the bottles are covered.
- Finally, the storage workstation get the bottles and place them in the desired storage position.

Each workstation is locally commanded by a PLC device and, in turn, a central PLC coordinates all workstations. The communication network between workstations and PC is based on the Ethernet protocol.

The "AE-PLC-FMS14" include a SCADA system that works collecting the data of the Ethernet network that is connected to each PLC and the central PLC. The SCADA system allows the visualization from the PC of the production state, and the change of the production parameters in real time.

The "AE-PLC-FMS14" system design by EDIBON allows the users to learn the basic concepts of automation as the operation of an Ethernet network or how to program a PLC and about other areas as pneumatic, electro-pneumatic, industrial controller's technology, etc.

The optional "AE-AS" software is design to teach the students how works real automation software. This software allows making 2D and 3D processes simulations, supervising and controlling SCADA systems, programming and communicating PLCs, simulating hydraulic, pneumatic and electronic devices operation, etc.

With this unit there are several options and possibilities:

- Main items: 1, 2, 3, 4, 5, 6 and 7.
- Optional items: 8, 9 and 10.

Let us describe first the main items (1 to 7):

① **AE-PLC-FMS14. Unit:**

* Available PLC models of different manufacturers: PANASONIC, SIEMENS, OMRON, MITSUBISHI, ALLEN BRADLEY, etc.

② AE-PLC-PAN-UB. **PANASONIC PLC Base Unit**, includes:

• N-ALI02. **Domestic Power Supply.**

Supply voltage (Single-Phase): 230V AC, PH+N+G.

ON-OFF removable key.

Output Voltage Connections:

Two Single-Phase: 230V AC.

Single-Phase supply wire connecting plug.

Differential magnetothermal, 2 poles, 25A, 30mA AC 6KA.



N-ALI02

• N-CPU-PAN. **Panasonic CPU Module.**

Supply voltage (Single-Phase): 100-240V AC PH+N+G.

Overcurrent protection with fuse.

PLC device, Panasonic FP7:

High processing speed: 11ns per basic instruction (step).

Programming capacity: 120k basic instructions (step).

Data logging capacity: 256k words.

Independent memory for comments: 3MB.

Supports SDHC type generic memory cards up to 32GB.

Expansion module for digital inputs:

16 digital inputs with allowable input range from 0V to 12V or 0V to 24V.

Expansion module for digital outputs:

16 relay type digital outputs with voltage level of 24V DC.

Web server function:

HTML web server included in the PLC.

Up to 16 sessions at the same time.

Compatible with most common search engines.

Connector for the digital input and output signals.

Connector to the Ethernet switch module (N-SWT-4 or N-SWT-8).



N-CPU-PAN

There are available the following optionals Kits to work with the AE-PLC-PAN-UB:

The PLC-PAN-K1, **PANASONIC PLC Kit 1 (Optional)** includes:

• N-MT. **Test module.**

Supply voltage (Single-Phase): 100-240V ac PH+N+G.

20 Digital Signal Generators:

10 Switches.

10 Push buttons.

Every output has attached a green LED.

Output voltage levels of 0V dc and 24V dc.

6 Analog Signal Generators:

6 Potentiometers.

Output voltage range from -10V to +10V.

Single-Phase supply hose connecting plug.

Differential magneto-thermal, 2 poles, 25A, 30mA AC 6KA.



N-MT

The PLC-PAN-K2, **PANASONIC PLC Kit 2 (Optional)** includes:

- **N-ESA-PAN. Panasonic Analog I/O Module.**

Supply voltage (Single-Phase): 100-240V AC PH+N+G.

Expansion unit for analog inputs:

Input voltage range from -10V to +10V.

4 analog inputs.

Resolution of 12 bits.

Expansion unit for analog outputs:

Output voltage range from -10V to +10V.

4 analog outputs.

Resolution of 12 bits.

Connector for the analog input and output signals.

Connector to the Ethernet switch module (N-SWT-4 or N-SWT-8).



N-ESA-PAN

- **N-SWT-4. 4 Ports Ethernet Switch Module.**

Supply voltage (Single-Phase): 100-240V AC PH+N+G.

Compact switch module:

4 Ethernet ports.

Work as Ethernet interconnection point.



N-SWT-4

The PLC-PAN-K4, **PANASONIC PLC Kit 4 (Optional)** includes:

- **N-HMIA-PAN. Panasonic Large HMI Module.**

Supply voltage (Single-Phase): 100-240V AC PH+N+G.

HMI device:

Touchscreen.

TFT display of 64K colors and 16:9 format.

Size of the display: 187 x 147mm (7 inches).

Resolution: 800 x 480 WVGA.

Backlight with high brightness of 300cd/m².

SD card slot.

Connector to the Ethernet switch module (N-SWT-4 or N-SWT-8).



N-HMIA-PAN

- **N-SWT-4. 4 Ports Ethernet Switch Module.**

Supply voltage (Single-Phase): 100-240V AC PH+N+G.

Compact switch module:

4 Ethernet ports.

Work as Ethernet interconnection point.



N-SWT-4

The PLC-PAN-K5, **PANASONIC PLC Kit 5 (Optional)** includes:

- **N-MOD. Modem Communication Module.**

Supply voltage (Single-Phase): 100-240V AC PH+N+G.

Internet router with RJ-11 socket to connect the phone line.



N-MOD

• N-SWT-8. **8 Ports Ethernet Switch Module.**

Supply voltage (Single-Phase): 100-240V AC PH+N+G.

Compact switch module:

8 Ethernet ports.

Work as Ethernet interconnection point.



N-SWT-8

• AE-AS. **Automation Systems Simulation Software. (Optional).**

2D and 3D systems simulations.

Configurable simulation speed with the modes “normal simulation”, “slow motion simulation”, “step-by-step simulation” and “pause”.

3D editor to import pieces made with formats compatible with most 3D design programs (.STEP, .STL and .IGES). Capacity to generate 2D and 3D animations associated to the results of the simulation the user is working with.

Capacity for simulating the following systems:

Hydraulic and electrohydraulic: according to ISO 1219-1 and 1219-2 standards, with an extensive library of hydraulic and electrohydraulic components with its standardized symbol.

Pneumatics and electro-pneumatics: with an extensive library of pneumatic, electro-pneumatic and pneumatic logic components.

Capacity to modify the most important parameters of each hydraulic and pneumatic component, such as: efficiency curves, external loads, leaks, viscosity, thermal characteristics, etc.

Digital electronics: with an extensive library of standard electronic components (logic gates, amplifiers, transistors, displays, multiplexers, etc.).

Electrical Single-Line Diagram: with a library that enables to create diagrams for all levels of voltage usually employed in power generation, transport and distribution networks.

Electrical engineering: with a library that contains a great amount of components to create simple and complex electrical circuits. The models of the components included are generic and real and belong to several manufacturers.

All the libraries include the components and its standardized symbol.

Capacity to program with the following languages:

GRAFCET: allows encapsulated stages for a better organization of the programmed control structures.

Block Diagram: blocks included are preset but they can be completely configured by the user.

Ladder: includes three libraries to program automata from Siemens, Allen Bradley and those fulfilling the IEC61131-3 standard, allowing the PLC to program directly. It also allows for creating and simulating the PLC program in the automated system simulated by the software.

Digital logic: with an extensive library of logic gates and components configured by the user.

Function blocks with configurable structured text.

Direct programming in the PLCs from the manufacturers Siemens, Allen Bradley and those fulfilling the IEC61131-3 standard of the programs simulated in the software.

Supervision, control and simulation of the manufacturing process of each station and the complete assembly by a SCADA system.

Communication with the PLCs of the unit is performed via OPC protocol.

Includes the 3D simulation of the automation system with the control panel and the visualization of the alarms generated by the system.

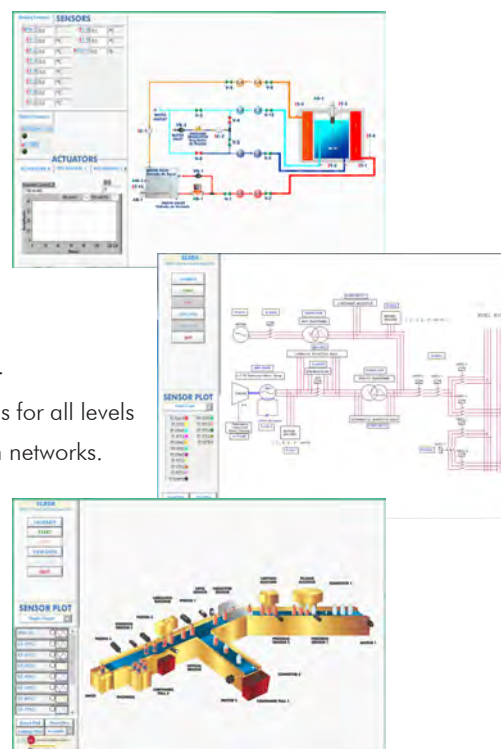

AE-AS

② PLC, HMI and web server programming software

PLC programming software:

Programming software developed according to the norm IEC 61131-3.

Compatible with Windows operating systems.

Five programming languages:

Ladder diagrams (LD). Structured text (ST). Instruction list (IL). Sequential function chart (SFC). Function block diagram (FBD).

Remote programming, service and diagnosis.

Minimum size of program.

Powerful debugging and monitoring tools.

Supports functions created by the user and function blocks.

Saves project files in the PLC.

Examples and quick tutorial included.

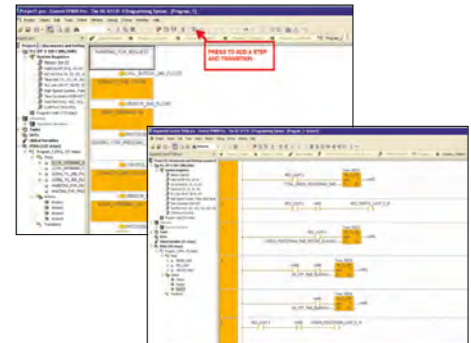

Software de programación de PLC

Programming software of the HMI touchscreen:

Tool to create screens:

This software is a tool created to program the touchscreen. Thanks to this tool, appropriate screens and images can be designed and created. Enables the transfer of the program to the touchscreen, uploading objects created from the terminal and print screens created.

Lots of functions. Creation of screens:

Includes many programming tools.

Text, diagram or data display devices, buttons for drawings, charts and pilot lights.

Creation of functional screens adaptable to each application.

Drawing functions: creation of different programming elements through icons and bitmaps.

Easy operation (drag and drop):

A library of elements allows for programming with the mouse by just selecting and moving elements to the desired locations (drag and drop).

Easy user libraries creation:

Libraries can be registered and stored to be used in later projects.

Printing. The project screens can be printed:

Screens can be printed after previewing, selecting and configuring them.

Bitmaps editor:

This tool allows the creation, reading and modification of bitmaps to use them as programming elements in the screen. Icons (buttons) can be created from images.

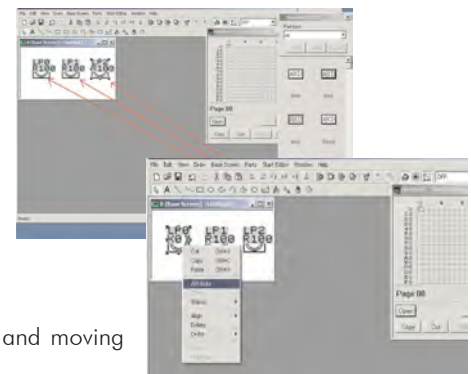

Software de Programación de la Pantalla Táctil HMI

Web applications programming software:

Easy programming of complete web applications to display and control all the variables of the PLC. No previous experience in web programming is required.

Library of buttons, pushbuttons, needle indicators, bar charts, etc. for a quick programming of the applications.

The web applications can take up to 14 MB and allow up to 16 users to access at the same time.

Applications can be programmed to control all the digital and analog variables of the PLC.

Search engines compatible with the web server:

Windows: Google Chrome, Mozilla Firefox, Opera and Internet Explorer.

OS X: Safari, Google Chrome and Mozilla Firefox.

IOS: Safari and Google Chrome.

Android: Google Chrome.

③ Component Workstations:

⊕ AE-PLC-CP. Industrial Control Processes Workstation

The "AE-PLC-CP" is a process control workstation commanded by a PLC that coordinates the work of 4 industrial controllers that regulate in parallel the level, flow rate, temperature and pressure processes. The "AE-PLC-CP" is composed by three working tanks and a reservoir tank that is used by the unit to obtain the desired product, once obtained, the product is pumped to the next workstation thanks to a pumping system.

Tanks:

- 4 transparent tanks.
- 1.5 l of capacity each one approx.

Control panel:

- Mushroom head emergency stop push button switch.
- Start and Stop pushbuttons.
- Switch for manual or automatic operation.
- Light indicator.
- Led stack light.
- Terminal block to connect the individually identified inputs and outputs of the unit.

Electrical components:

- 4 PID industrial controllers:
 - Sample speed: 250 S/s.
 - USB connector to PC for configuration and data logging.
 - Software for the configuration and data logging.
- 2 Peltier cells to temperature control.
- Hydraulic pump with maximum flow rate of 8 l/min.
- Helix agitator with range from 0 to 300 rpm.
- 8 solenoid valves.
- Proportional electrovalve:
 - Nominal voltage: 24V DC.
 - Pressure control range: 0 to 6 bar.
 - Linearity: 1% full scale.

Pneumatic circuit:

- Air treatment unit:
 - Filter-regulator and water trap.
 - Manometer with double scale indicator.
 - Shut-off valve.
- Pneumatic monostable 3/2 solenoid valves.

Sensors:

- Thermocouple type J.
- Capacitive level sensor from 0 to 300 mm.
- Pressure sensor with range from 0 to 1 bar.
- Turbine type flow rate sensor with range from 0.25 to 6.5 l/min.
- 6 Capacitive sensors to control the maximum and minimum level of each tank.

Fault generation module:

- Box with lock with key.
- Allows generating 20 different faults.
- Each fault is generated through toggle switches.

*** Available PLC models of different manufacturers: PANASONIC, SIEMENS, OMRON, MITSUBISHI, ALLEN BRADLEY, etc.**

The AE-PLC-PAN-UB, **PANASONIC PLC Base Unit** includes:

- **N-ALI02. Domestic Power Supply.**
 - Supply voltage (Single-Phase): 230V AC, PH+N+G.
 - ON-OFF removable key.
 - Output Voltage Connections:
 - Two Single-Phase: 230V AC.
 - Single-Phase supply wire connecting plug.
 - Differential magnetothermal, 2 poles, 25A, 30mA AC 6KA.



N-ALI02

- **N-CPU-PAN. Panasonic CPU Module.**
 - Supply voltage (Single-Phase): 100-240V AC PH+N+G.
 - Overcurrent protection with fuse.
 - PLC device, Panasonic FP7:
 - High processing speed: 11ns per basic instruction (step).
 - Programming capacity: 120k basic instructions (step).
 - Data logging capacity: 256k words.
 - Independent memory for comments: 3MB.
 - Supports SDHC type generic memory cards up to 32GB.
 - Expansion module for digital inputs:
 - 16 digital inputs with allowable input range from 0V to 12V or 0V to 24V.
 - Expansion module for digital outputs:
 - 16 relay type digital outputs with voltage level of 24V DC.
 - Web server function:
 - HTML web server included in the PLC.
 - Up to 16 sessions at the same time.
 - Compatible with most common search engines.
 - Connector for the digital input and output signals.
 - Connector to the Ethernet switch module (N-SWT-4 or N-SWT-8).



N-CPU-PAN

③ Component Workstations:

⑥ AE-PLC-MR4. Rotary Table Workstation 4

The “AE-PLC-MR4” is an automatic filling and bottling workstation commanded by a PLC. The workstation “AE-PLC-MR4” is composed by a manufacturing rotary table that is used to supply bottles and plastic covers. The “AE-PLC-MR4” receive the product from the previous workstation “AE-PLC-CP”, and use it to fill each bottle in one position of the rotary table. Once each bottle is filled, it is cover before send it to the next workstation, through a pneumatic manipulator.

Control panel:

- Mushroom head emergency stop push button switch.
- Start and Stop pushbuttons.
- Switch for manual or automatic operation.
- Led stack light.
- Terminal block to connect the individually identified inputs and outputs of the unit.

Electrical components:

- DC Motor.
- Solenoid valve.

Pneumatic circuit:

- Air treatment unit:
 - Filter-regulator and water trap.
 - Manometer with double scale indicator.
 - Shut-off valve.
- Pneumatic double effect external grip clamp.
- Rotary pneumatic actuator from 0° to 180°
- 2 Pneumatic monostable 5/2 solenoid valve.

Sensors:

- IR beam detector.
- 3 Capacitive sensors.
- 4 reed effect limit switches.

Fault generation module:

- Box with lock with key.
- Allows generating 20 different faults.
- Each fault is generated through toggle switches.

*** Available PLC models of different manufacturers: PANASONIC, SIEMENS, OMRON, MITSUBISHI, ALLEN BRADLEY, etc.**

The AE-PLC-PAN-UB, **PANASONIC PLC Base Unit** includes:

- **N-ALIO2. Domestic Power Supply.**
 - Supply voltage (Single-Phase): 230V AC, PH+N+G.
 - ON-OFF removable key.
 - Output Voltage Connections:
 - Two Single-Phase: 230V AC.
 - Single-Phase supply wire connecting plug.
 - Differential magnetothermal, 2 poles, 25A, 30mA AC 6KA.
- **N-CPU-PAN. Panasonic CPU Module.**
 - Supply voltage (Single-Phase): 100-240V AC PH+N+G.
 - Overcurrent protection with fuse.
 - PLC device, Panasonic FP7:
 - High processing speed: 11ns per basic instruction (step).
 - Programming capacity: 120k basic instructions (step).
 - Data logging capacity: 256k words.
 - Independent memory for comments: 3MB.
 - Supports SDHC type generic memory cards up to 32GB.
 - Expansion module for digital inputs:
 - 16 digital inputs with allowable input range from 0V to 12V or 0V to 24V.
 - Expansion module for digital outputs:
 - 16 relay type digital outputs with voltage level of 24V DC.
 - Web server function:
 - HTML web server included in the PLC.
 - Up to 16 sessions at the same time.
 - Compatible with most common search engines.
 - Connector for the digital input and output signals.
 - Connector to the Ethernet switch module (N-SWT-4 or N-SWT-8).



N-ALIO2



N-CPU-PAN

③ Component Workstations:

⑤ AE-PLC-ALB. Bottling Storage Workstation.

The “AE-PLC-ALB” is an automatic storing system commanded by a PLC. The “AE-PLC-ALB” is composed by 3 degrees XYZ manipulator that uses a cup system with vacuum technology to place each bottle in the correct position of a numbered pallet. The workstation has a HMI screen to visualizing in an easy way the bottling storage. The workstation “AE-PLC-ALB” is the last step in the manufacturing process.

Control panel:

- Mushroom head emergency stop push button switch.
- Start and Stop pushbuttons.
- Switch for manual or automatic operation.
- Light indicator.
- Led stack light.
- Terminal block to connect the individually identified inputs and outputs of the unit.

Electrical components:

- 2 Electric linear actuators.
 - DC Motor.
 - Position detector.
 - Length: 500 mm.
 - Connector to the “N-SV” module.

Pneumatic circuit:

- Air treatment unit:
 - Filter-regulator and water trap.
 - Manometer with double scale indicator.
 - Shut-off valve.
- Double acting pneumatic profiled actuator.
- Pneumatic monostable 5/2 solenoid valve.

Vacuum circuit:

- Telescopic vacuum cup.
- Venturi effect vacuum ejector.
- 2 Pneumatic monostable 2/2 solenoid valves.
- 1 Pressure relief valve.

Sensors:

- IR beam detector.
- 2 Reed switches.

Fault generation module:

- Box with lock.
- Allows to generate 20 different faults.
- Each fault is generated through toggle switch.

*** Available PLC models of different manufacturers: PANASONIC, SIEMENS, OMRON, MITSUBISHI, ALLEN BRADLEY, etc.**

The AE-PLC-PAN-UB, **PANASONIC PLC Base Unit** includes:

- **N-ALI02. Domestic Power Supply.**
 - Supply voltage (Single-Phase): 230V AC, PH+N+G.
 - ON-OFF removable key.
 - Output Voltage Connections:
 - Two Single-Phase: 230V AC.
 - Single-Phase supply wire connecting plug.
 - Differential magnetothermal, 2 poles, 25A, 30mA AC 6KA.
- **N-CPU-PAN. Panasonic CPU Module.**
 - Supply voltage (Single-Phase): 100-240V AC PH+N+G.
 - Overcurrent protection with fuse.
 - PLC device, Panasonic FP7:
 - High processing speed: 11 ns per basic instruction (step).
 - Programing capacity: 120k basic instructions (step).
 - Data logging capacity: 256k words.
 - Independent memory for comments: 3MB.
 - Supports SDHC type generic memory cards up to 32GB.
 - Expansion module for digital inputs:
 - 16 digital inputs with allowable input range from 0V to 12V or 0V to 24V.
 - Expansion module for digital outputs:
 - 16 relay type digital outputs with voltage level of 24V DC.
 - Web server function:
 - HTML web server included in the PLC.
 - Up to 16 sessions at the same time.
 - Compatible with most common search engines.
 - Connector for the digital input and output signals.
 - Connector to the Ethernet switch module (N-SWT-4 or N-SWT-8).



N-ALI02



N-CPU-PAN

③ Component Workstations:

The PLC-PAN-K4, **PANASONIC PLC Kit 4 (Optional)** includes:

- N-HMIA-PAN. **Panasonic Large HMI Module.**

Supply voltage (Single-Phase): 100-240V AC PH+N+G.

HMI device:

Touchscreen.

TFT display of 64K colors and 16:9 format.

Size of the display: 187 x 147mm (7 inches).

Resolution: 800 x 480 WVGA.

Backlight with high brightness of 300cd/m².

SD card slot.

Connector to the Ethernet switch module (N-SWT-4 or N-SWT-8).



N-HMIA-PAN

- N-SWT-4. **4 Ports Ethernet Switch Module.**

Supply voltage (Single-Phase): 100-240V AC PH+N+G.

Compact switch module:

4 Ethernet ports.

Work as Ethernet interconnection point.

The complete unit includes as well:

Advanced Real-Time SCADA.

Open Control + Multicontrol + Real-Time Control.

Specialized EDIBON Control Software based on LabVIEW.

PLC, HMI and web server programming software.

Projector and/or electronic whiteboard compatibility allows the unit to be explained and demonstrated to an entire class at one time.

Capable of doing applied research, real industrial simulation, training courses, etc.

Remote operation and control by the user and remote control for EDIBON technical support, are always included.

Totally safe, utilizing 4 safety systems (Mechanical, Electrical, Electronic & Software).

Designed and manufactured under several quality standards.

Optional software for the realization of 2D and 3D simulation, variables monitoring and SCADA control of the flexible manufacturing system.

Optional ICAI software to create, edit and carry out practical exercises, tests, exams, calculations, etc. Apart from monitoring user's knowledge and progress reached.

This unit has been designed for future expansion and integration. A common expansion is the EDIBON Scada-Net (ESN) System which enables multiple students to simultaneously operate many units in a network.



N-SWT-4

④ SAC. Silent Air Compressor Unit

Designed to work with the EDIBON units.

Single-phase motor with 340 W.

Low noise level with 40 dB of maximum.

Boiler capacity: 9 l.

Maximum pressure: 8 bar or 0.8 MPa.

Maximum air flow: 50 l/min.

Safety relief valve.

Start/stop switch.

Double scale manometer psi and bar with a range from 0 to 12 bar to measure the air pressure before the air filter regulator.

Air Filter Regulator (FR):

Double scale manometer psi and bar with a range from 0 to 12 bar to measure the air pressure after the air filter regulator.

Air filter with drain.

Air pressure regulator from 0 to 8 bar.

6 mm quick release connector of 6mm for pneumatic flexible tubes.

Oil level indicator.

The oil necessary to work is included with the unit.

Include the connector types to work with pneumatic trainers of EDIBON.



SAC

⑤ **AE-PLC-FMS14/CCSOF. Computer Control + Data Acquisition + Data Management Software:**

The three softwares are part of the SCADA system.

Compatible with actual Windows operating systems. Graphic and intuitive simulation of the process in screen. **Compatible with the industry standards.**

Registration and visualization of all process variables in an automatic and simultaneous way.

Flexible, open and multicontrol software, developed with actual windows graphic systems, acting simultaneously on all process parameters.

Management, processing, comparison and storage of data.

It allows the registration of the alarms state and the graphic representation in real time.

Comparative analysis of the obtained data, after the process and modification of the conditions during the process.

Open software, allowing the teacher to modify texts, instructions. Teacher's and

student's passwords to facilitate the teacher's control on the student, and allowing the access to different work levels.

This unit allows the 30 students of the classroom to visualize simultaneously all the results and the manipulation of the unit, during the process, by using a projector or an electronic whiteboard.



AE-PLC-FMS14/CCSOF

⑥ **Cables and Accessories**, for normal operation.

⑦ **Manuals:**

This unit is **supplied with 7 manuals:** Required Services, Assembly and Installation, Control Software, Starting-up, Safety, Maintenance & Practices Manuals.

*References 1 to 7 are the main items: AE-PLC-FMS14 + PLC, HMI and web server programming software + Component Workstations SAC + AE-PLC-FMS14/CCSOF + Cables and Accessories + Manuals are included in the minimum supply for enabling normal and full operation.

EXERCISES AND PRACTICAL POSSIBILITIES TO BE DONE WITH THE MAIN ITEMS

Practical possibilities to be done with the Flexible Manufacturing System 14 (AE-PLC-FMS14):

- 1.-Introduction to flexible manufacturing system (FMS).
- 2.-Introduction to pneumatics and electro-pneumatics.
- 3.-Study of the sensor detection.
- 4.-Testing the digital inputs and outputs of the automatic system through a PLC.
- 5.-Modify manufacturing parameters through the PLC.
- 6.-Configuration of a pneumatic application.
- 7.-Introduction to the Human-machine interface systems (HMI).
- 8.-Study of an automatic control of an industrial system.
- 9.-Control of the flexible manufacturing system through a central PLC in an Ethernet network with local PLC in each workstation.
- 10.-Manage the flexible manufacturing system through the HMI device.
- 11.-SCADA control of an automatic industrial system through PC.

Practical possibilities to be done with the optional software Automation Systems Simulation Software (AE-AS):

- 12.-Introduction to the SCADA control system.
- 13.-OPC server system with Ethernet.
- 14.-SCADA control of an automatic industrial system through PC.

Practical possibilities to be done with the Workstation alone:

- Industrial Control Processes Workstation (AE-PLC-CP).

- 15.-Manual control of a water tank temperature.
- 16.-Manual control of a water tank level.
- 17.-Manual control of a water flow.
- 18.-Manual control of a water pressure.
- 19.-Automatic control of a water tank temperature through an industrial controller.
- 20.-Automatic control of a water tank level through an industrial controller.
- 21.-Automatic control of a water flow through an industrial controller.
- 22.-Automatic control of a water pressure through an industrial controller.
- 23.-Change the parameters of the different controls.
- 24.-Optimize the process time of the different industrial controls.
- 25.-Study and analysis of the faults inserted in the process with the fault generation module.

- Rotary Table Workstation 4 (AE-PLC-MR4).

- 26.-Manual control of the rotary table system.
- 27.-Manual control of a bottles feeding system.
- 28.-Manual control of a filling system.
- 29.-Manual control of a bottles covering system.
- 30.-Automatic control of the rotary table system.
- 31.-Automatic control of a bottles feeding system.
- 32.-Automatic control of a filling system.
- 33.-Automatic control of a bottles covering system.
- 34.-Change the parameters of the process.
- 35.-Optimization of the process time.
- 36.-Study and analysis of the faults inserted in the process with the fault generation module.

- Bottling Storage Workstation (AE-PLC-ALB).

- 37.-Manual control of the bottles storage system.
- 38.-Automatic control of the bottles storage system.
- 39.-Change the parameters of the storage process.
- 40.-Optimize the process time.
- 41.-Study and analysis of the faults inserted in the process with the fault generation module.

Other possibilities to be done with this Unit:

- 42.-Many students view results simultaneously.
To view all results in real time in the classroom by means of a projector or an electronic whiteboard.
 - 43.-Open Control, Multicontrol and Real Time Control.
This unit allows intrinsically and/or extrinsically to change the span, gains; proportional, integral, derivative parameters; etc, in real time.
 - 44.-The Computer Control System with SCADA allows a real industrial simulation.
 - 45.-This unit is totally safe as uses mechanical, electrical and electronic, and software safety devices.
 - 46.-This unit can be used for doing applied research.
 - 47.-This unit can be used for giving training courses to Industries even to other Technical Education Institutions.
 - 48.-Control of the AE-PLC-FMS14 unit process through the control interface box without the computer.
 - 49.-Visualization of all the sensors values used in the AE-PLC-FMS14 unit process.
- Several other exercises can be done and designed by the user.

REQUIRED SERVICES

- Electrical supply: single phase, 220V./50 Hz. or 110V./60 Hz.
- Computer.

DIMENSIONS AND WEIGHTS

- AE-PLC-FMS14 unit:
- Dimensions: 3000 x 800 x 1500 mm. approx.
(118.10 x 31.49 x 59.05 inches approx.)
 - Weight: 400 Kg. approx.
(881 pounds approx.).

RECOMMENDED ACCESSORIES (Not included)

- AE-AS. Automation System Simulation Software (Optional).

AVAILABLE VERSIONS

- AE-PLC-FMS14. Flexible Manufacturing System 14.

Offered in this catalogue:

Offered in other catalogue:

- AE-PLC-FMS1. Flexible Manufacturing System 1.
- AE-PLC-FMS2. Flexible Manufacturing System 2.
- AE-PLC-FMS3. Flexible Manufacturing System 3.
- AE-PLC-FMS4. Flexible Manufacturing System 4.
- AE-PLC-FMS5. Flexible Manufacturing System 5.
- AE-PLC-FMS6. Flexible Manufacturing System 6.
- AE-PLC-FMS7. Flexible Manufacturing System 7.
- AE-PLC-FMS8. Flexible Manufacturing System 8.
- AE-PLC-FMS9. Flexible Manufacturing System 9.
- AE-PLC-FMS10. Flexible Manufacturing System 10.
- AE-PLC-FMS11. Flexible Manufacturing System 11.
- AE-PLC-FMS12. Flexible Manufacturing System 12.
- AE-PLC-FMS13. Flexible Manufacturing System 13.

COMPLETE TECHNICAL SPECIFICATIONS (for optional items)

Additionally to the main items (1 to 7) described, we can offer, as optional, other items from 8 to 10.

All these items try to give more possibilities for:

- a) Technical and Vocational Education configuration. (ICAI)
- b) Multipost Expansions options. (MINI ESN and ESN)

a) Technical and Vocational Education configuration

③ AE-PLC-FMS41/ICAI. Interactive Computer Aided Instruction Software System.

This complete software package consists of an Instructor Software (EDIBON Classroom Manager - ECM-SOF) totally integrated with the Student Software (EDIBON Student Labsoft - ESL-SOF). Both are interconnected so that the teacher knows at any moment what is the theoretical and practical knowledge of the students.

This software is optional and can be used additionally to items (1 to 7).

- ECM-SOF. EDIBON Classroom Manager (Instructor Software).

ECM-SOF is the application that allows the Instructor to register students, manage and assign tasks for workgroups, create own content to carry out Practical Exercises, choose one of the evaluation methods to check the Student knowledge and monitor the progression related to the planned tasks for individual students, workgroups, units, etc... so the teacher can know in real time the level of understanding of any student in the classroom.

Innovative features:

- User Data Base Management.
- Administration and assignment of Workgroup, Task and Training sessions.
- Creation and Integration of Practical Exercises and Multimedia Resources.
- Custom Design of Evaluation Methods.
- Creation and assignment of Formulas & Equations.
- Equation System Solver Engine.
- Updatable Contents.
- Report generation, User Progression Monitoring and Statistics.

- ESL-SOF. EDIBON Student Labsoft (Student Software).

ESL-SOF is the application addressed to the Students that helps them to understand theoretical concepts by means of practical exercises and to prove their knowledge and progression by performing tests and calculations in addition to Multimedia Resources. Default planned tasks and an Open workgroup are provided by EDIBON to allow the students start working from the first session. Reports and statistics are available to know their progression at any time, as well as explanations for every exercise to reinforce the theoretically acquired technical knowledge.

Innovative features:

- Student Log-In & Self-Registration.
- Existing Tasks checking & Monitoring.
- Default contents & scheduled tasks available to be used from the first session.
- Practical Exercises accomplishment by following the Manual provided by EDIBON.
- Evaluation Methods to prove your knowledge and progression.
- Test self-correction.
- Calculations computing and plotting.
- Equation System Solver Engine.
- User Monitoring Learning & Printable Reports.
- Multimedia-Supported auxiliary resources.

For more information see ICAI catalogue. Click on the following link:

www.edibon.com/en/files/expansion/ICAI/catalog

Instructor Software

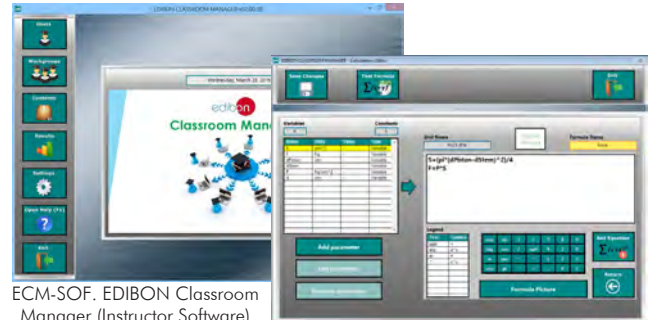

ECM-SOF. EDIBON Classroom Manager (Instructor Software) Application Main Screen

ECAL. EDIBON Calculations Program Package - Formula Editor Screen



ERS. EDIBON Results & Statistics Program Package - Student Scores Histogram

ETTE. EDIBON Training Test & Exam Program Package - Main Screen with Numeric Result Question

Student Software

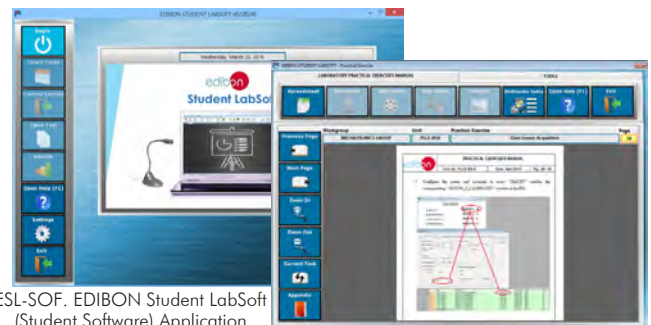

ESL-SOF. EDIBON Student LabSoft (Student Software) Application Main Screen

EPE. EDIBON Practical Exercise Program Package Main Screen

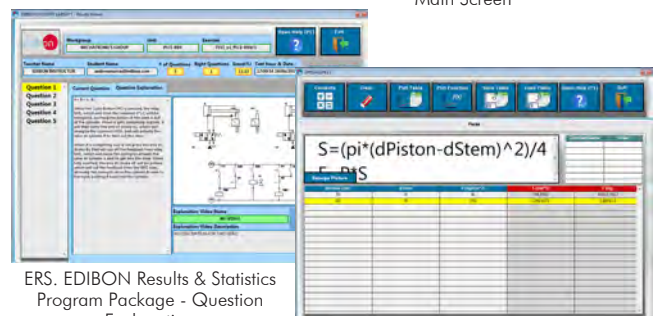

ERS. EDIBON Results & Statistics Program Package - Question Explanation

ECAL. EDIBON Calculations Program Package Main Screen

b) Multipost Expansions options

⑨ **MINI ESN. EDIBON Mini Scada-Net System for being used with EDIBON Teaching Units.**

MINI ESN. EDIBON Mini Scada-Net System allows up to 30 students to work with a Teaching Unit in any laboratory, simultaneously. It is useful for both, Higher Education and/or Technical and Vocational Education.

The MINI ESN system consists of the adaptation of any EDIBON Computer Controlled Unit with SCADA integrated in a local network.

This system allows to view/control the unit remotely, from any computer integrated in the local net (in the classroom), through the main computer connected to the unit. Then, the number of possible users who can work with the same unit is higher than in an usual way of working (usually only one).

Main characteristics:

- It allows up to 30 students to work simultaneously with the EDIBON Computer Controlled Unit with SCADA, connected in a local net.
- Open Control + Multicontrol + Real Time Control + Multi Student Post.
- Instructor controls and explains to all students at the same time.
- Any user/student can work doing "real time" control/multicontrol and visualisation.
- Instructor can see in the computer what any user/student is doing in the unit.
- Continuous communication between the instructor and all the users/students connected.

Main advantages:

- It allows an easier and quicker understanding.
- This system allows you can save time and cost.
- Future expansions with more EDIBON Units.

For more information see Mini ESN catalogue. Click on the following link:

www.edibon.com/products/catalogues/en/Mini-ESN.pdf

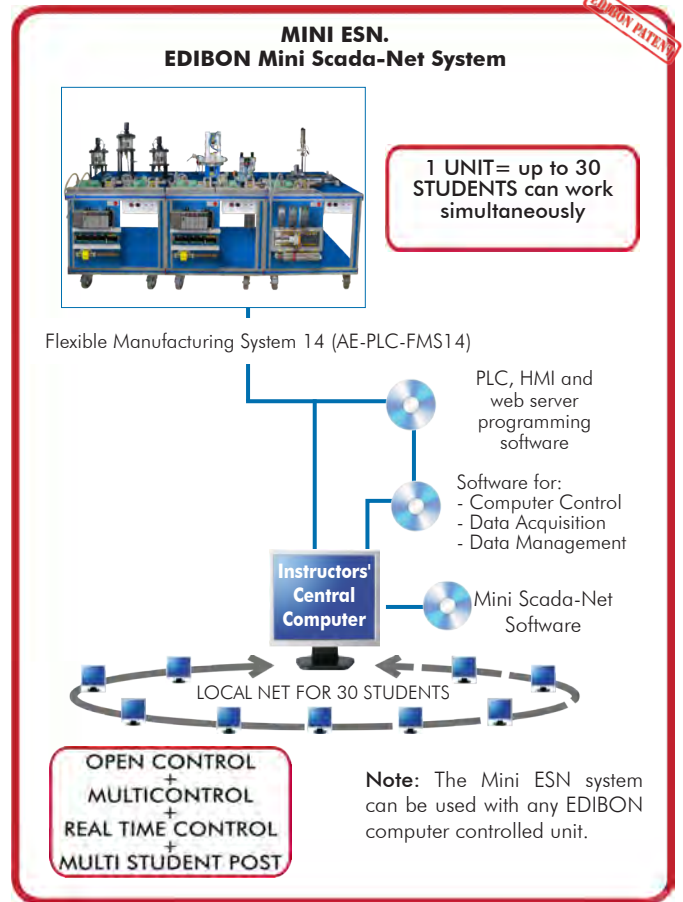

⑩ **ESN. EDIBON Scada-Net Systems.**

This unit can be integrated, in the future, into a Complete Laboratory with many Units and many Students.

For more information see ESN catalogue. Click on the following link:

www.edibon.com/en/files/expansion/ESN/catalog

ORDER INFORMATION

Main items (always included in the supply)

Minimum supply always includes:

- ① **Unit: AE-PLC-FMS14. Flexible Manufacturing System 14.**
- ② **PLC, HMI and web server programming software.**
- ③ **Component Workstations:**
 - ① AE-PLC-CP. **Industrial Control Processes Workstation**
 - ② AE-PLC-MR4. **Rotary Table Workstation 4.**
 - ③ AE-PLC-ALB. **Bottling Storage Workstation.**
- ④ **AE-PLC-FMS14/CCSOF. Computer Control + Data Acquisition + Data Management Software.**
- ⑤ **SAC. Silent Air Compressor Unit.**
- ⑥ **Cables and Accessories**, for normal operation.
- ⑦ **Manuals.**

*IMPORTANT: Under AE-PLC-FMS14 we always supply all the elements for immediate running as 1, 2, 3, 4, 5, 6, and 7.

Optional items (supplied under specific order)

- a) Technical and Vocational Education configuration
- ⑧ AE-PLC-FMS14/ICAI. **Interactive Computer Aided Instruction Software System.**
 - b) Multipost Expansions options
- ⑨ MINI ESN. EDIBON Mini Scada-Net System for being used with EDIBON Teaching Units.
- ⑩ ESN. EDIBON Scada-Net Systems.

① **AE-PLC-FMS14. Unit:**

* Available PLC models of different manufacturers: PANASONIC, SIEMENS, OMRON, MITSUBISHI, ALLEN BRADLEY, etc.

② **AE-PLC-PAN-UB. PANASONIC PLC Base Unit, includes:**

- N-ALI02. Domestic Power Supply.
Supply voltage (Single-Phase): 230V AC, PH+N+G.
ON-OFF removable key.
Output Voltage Connections:
Two Single-Phase: 230V AC.
Single-Phase supply wire connecting plug.
Differential magnetothermal, 2 poles, 25A, 30mA AC 6KA.
- N-CPU-PAN. Panasonic CPU Module.
Supply voltage (Single-Phase): 100-240V AC PH+N+G.
Overcurrent protection with fuse.
PLC device, Panasonic FP7:
High processing speed: 11ns per basic instruction (step).
Programming capacity: 120k basic instructions (step).
Data logging capacity: 256k words.
Independent memory for comments: 3MB.
Supports SDHC type generic memory cards up to 32GB.
Expansion module for digital inputs:
16 digital inputs with allowable input range from 0V to 12V or 0V to 24V.
Expansion module for digital outputs:
16 relay type digital outputs with voltage level of 24V DC.
Web server function:
HTML web server included in the PLC.
Up to 16 sessions at the same time.
Compatible with most common search engines.
Connector for the digital input and output signals.
Connector to the Ethernet switch module (N-SWT-4 or N-SWT-8).

There are available the following optional Kits to work with the AE-PLC-PAN-UB:

The PLC-PAN-K1, PANASONIC PLC Kit 1 (Optional) includes:

- N-MT. Test module.
Supply voltage (Single-Phase): 100-240V ac PH+N+G.
20 Digital Signal Generators:
10 Switches.
10 Push buttons.
Every output has attached a green LED.
Output voltage levels of 0V DC and 24V DC.
6 Analog Signal Generators:
6 Potentiometers.
Output voltage range from -10V to +10V.
Single-Phase supply hose connecting plug.
Differential magneto-thermal, 2 poles, 25A, 30mA AC 6KA.

The PLC-PAN-K2, PANASONIC PLC Kit 2 (Optional) includes:

- N-ESA-PAN. Panasonic Analog I/O Module.
Supply voltage (Single-Phase): 100-240V AC PH+N+G.
Expansion unit for analog inputs:
Input voltage range from -10V to +10V.
4 analog inputs.
Resolution of 12 bits.
Expansion unit for analog outputs:
Output voltage range from -10V to +10V.
4 analog outputs.
Resolution of 12 bits.
Connector for the analog input and output signals.
Connector to the Ethernet switch module (N-SWT-4 or N-SWT-8).

- N-SWT-4. 4 Ports Ethernet Switch Module.
Supply voltage (Single-Phase): 100-240V AC PH+N+G.
Compact switch module:
4 Ethernet ports.
Work as Ethernet interconnection point.

The PLC-PAN-K4, PANASONIC PLC Kit 4 (Optional) includes:

- N-HMIA-PAN. Panasonic Large HMI Module.
Supply voltage (Single-Phase): 100-240V AC PH+N+G.
HMI device:
Touchscreen.
TFT display of 64K colors and 16:9 format.
Size of the display: 187 x 147mm (7 inches).
Resolution: 800 x 480 WVGA.
Backlight with high brightness of 300cd/m².
SD card slot.
Connector to the Ethernet switch module (N-SWT-4 or N-SWT-8).
- N-SWT-4. 4 Ports Ethernet Switch Module.

Especificaciones de Concurso (de los items principales)

Supply voltage (Single-Phase): 100-240V AC PH+N+G.

Compact switch module:

4 Ethernet ports.

Work as Ethernet interconnection point.

The PLC-PAN-K5, PANASONIC PLC Kit 5 (Optional) includes:

- N-MOD. Modem Communication Module.

Supply voltage (Single-Phase): 100-240V AC PH+N+G.

Internet router with RJ-11 socket to connect the phone line.

- N-SWT-8. 8 Ports Ethernet Switch Module.

Supply voltage (Single-Phase): 100-240V AC PH+N+G.

Compact switch module:

8 Ethernet ports.

Work as Ethernet interconnection point.

- AE-AS. Automation Systems Simulation Software. (Optional).

2D and 3D systems simulations.

Configurable simulation speed with the modes "normal simulation", "slow motion simulation", "step-by-step simulation" and "pause".

3D editor to import pieces made with formats compatible with most 3D design programs (.STEP, .STL and .IGES). Capacity to generate 2D and 3D animations associated to the results of the simulation the user is working with.

Capacity for simulating the following systems:

Hydraulic and electrohydraulic: according to ISO 1219-1 and 1219-2 standards, with an extensive library of hydraulic and electrohydraulic components with its standardized symbol.

Pneumatics and electro-pneumatics: with an extensive library of pneumatic, electro-pneumatic and pneumatic logic components.

Capacity to modify the most important parameters of each hydraulic and pneumatic component, such as: efficiency curves, external loads, leaks, viscosity, thermal characteristics, etc.

Digital electronics: with an extensive library of standard electronic components (logic gates, amplifiers, transistors, displays, multiplexers, etc.).

Electrical Single-Line Diagram: with a library that enables to create diagrams for all levels of voltage usually employed in power generation, transport and distribution networks.

Electrical engineering: with a library that contains a great amount of components to create simple and complex electrical circuits. The models of the components included are generic and real and belong to several manufacturers.

All the libraries include the components and its standardized symbol.

Capacity to program with the following languages:

GRAFCET: allows encapsulated stages for a better organization of the programmed control structures.

Block Diagram: blocks included are preset but they can be completely configured by the user.

Ladder: includes three libraries to program automata from Siemens, Allen Bradley and those fulfilling the IEC61131-3 standard, allowing the PLC to program directly. It also allows for creating and simulating the PLC program in the automated system simulated by the software.

Digital logic: with an extensive library of logic gates and components configured by the user.

Function blocks with configurable structured text.

Direct programming in the PLCs from the manufacturers Siemens, Allen Bradley and those fulfilling the IEC61131-3 standard of the programs simulated in the software.

Supervision, control and simulation of the manufacturing process of each station and the complete assembly by a SCADA system.

Communication with the PLCs of the unit is performed via OPC protocol.

Includes the 3D simulation of the automation system with the control panel and the visualization of the alarms generated by the system.

② PLC, HMI and web server programming software

PLC programming software:

Programming software developed according to the norm IEC 61131-3.

Compatible with Windows operating systems.

Five programming languages:

Ladder diagrams (LD). Structured text (ST). Instruction list (IL). Sequential function chart (SFC). Function block diagram (FBD).

Remote programming, service and diagnosis.

Minimum size of program.

Powerful debugging and monitoring tools.

Supports functions created by the user and function blocks.

Saves project files in the PLC.

Examples and quick tutorial included.

Programming software of the HMI touchscreen:

Tool to create screens:

This software is a tool created to program the touchscreen. Thanks to this tool, appropriate screens and images can be designed and created. Enables the transfer of the program to the touchscreen, uploading objects created from the terminal and print screens created.

Lots of functions. Creation of screens:

Includes many programming tools.

Text, diagram or data display devices, buttons for drawings, charts and pilot lights. Creation of functional screens adaptable to each application.

Drawing functions: creation of different programming elements through icons and bitmaps.

Easy operation (drag and drop):

A library of elements allows for programming with the mouse by just selecting and moving elements to the desired locations (drag and drop).

Easy user libraries creation:

Libraries can be registered and stored to be used in later projects.

Printing. The project screens can be printed:

Screens can be printed after previewing, selecting and configuring them.

Bitmaps editor:

This tool allows the creation, reading and modification of bitmaps to use them as programming elements in the screen. Icons (buttons) can be created from images.

Web applications programming software:

Easy programming of complete web applications to display and control all the variables of the PLC. No previous experience in web programming is required.

Library of buttons, pushbuttons, needle indicators, bar charts, etc. for a quick programming of the applications.

The web applications can take up to 14 MB and allow up to 16 users to access at the same time.

Applications can be programmed to control all the digital and analog variables of the PLC.

Search engines compatible with the web server:

Windows: Google Chrome, Mozilla Firefox, Opera and Internet Explorer.

OS X: Safari, Google Chrome and Mozilla Firefox.

IOS: Safari and Google Chrome.

Android: Google Chrome.

③ Component Workstations:

③.1 AE-PLC-CP. Industrial Control Processes Workstation

The "AE-PLC-CP" is a process control workstation commanded by a PLC that coordinates the work of 4 industrial controllers that regulate in parallel the level, flow rate, temperature and pressure processes. The "AE-PLC-CP" is composed by three working tanks and a reservoir tank that is used by the unit to obtain the desired product, once obtained, the product is pumped to the next workstation thanks to a pumping system.

Tanks:

- 4 transparent tanks.
- 1.5 l of capacity each one approx.

Control panel:

- Mushroom head emergency stop push button switch.
- Start and Stop pushbuttons.
- Switch for manual or automatic operation.
- Light indicator.
- Led stack light.
- Terminal block to connect the individually identified inputs and outputs of the unit.

Electrical components:

- 4 PID industrial controllers:
 - Sample speed: 250 S/s.
 - USB connector to PC for configuration and data logging.
 - Software for the configuration and data logging.
- 2 Peltier cells to temperature control.
- Hydraulic pump with maximum flow rate of 8 l/min.
- Helix agitator with range from 0 to 300 rpm.
- 8 solenoid valves.
- Proportional electrovalve:
 - Nominal voltage: 24V DC.
 - Pressure control range: 0 to 6 bar.
 - Linearity: 1% full scale.

Pneumatic circuit:

- Air treatment unit:
 - Filter-regulator and water trap.
 - Manometer with double scale indicator.
 - Shut-off valve.
- Pneumatic monostable 3/2 solenoid valves.

Sensors:

- Thermocouple type J.
- Capacitive level sensor from 0 to 300 mm.
- Pressure sensor with range from 0 to 1 bar.
- Turbine type flow rate sensor with range from 0.25 to 6.5 l/min.
- 6 Capacitive sensors to control the maximum and minimum level of each tank.

Fault generation module:

- Box with lock with key.
- Allows generating 20 different faults.
- Each fault is generated through toggle switches.

* Available PLC models of different manufacturers: PANASONIC, SIEMENS, OMRON, MITSUBISHI, ALLEN BRADLEY, etc.

The AE-PLC-PAN-UB, PANASONIC PLC Base Unit includes:

- N-ALI02. Domestic Power Supply.
 - Supply voltage (Single-Phase): 230V AC, PH+N+G.
 - ON-OFF removable key.
 - Output Voltage Connections:
 - Two Single-Phase: 230V AC.
 - Single-Phase supply wire connecting plug.
 - Differential magnetothermal, 2 poles, 25A, 30mA AC 6KA.
- N-CPU-PAN. Panasonic CPU Module.
 - Supply voltage (Single-Phase): 100-240V AC PH+N+G.
 - Overcurrent protection with fuse.
 - PLC device, Panasonic FP7:
 - High processing speed: 11 ns per basic instruction (step).
 - Programming capacity: 120k basic instructions (step).
 - Data logging capacity: 256k words.
 - Independent memory for comments: 3MB.
 - Supports SDHC type generic memory cards up to 32GB.
 - Expansion module for digital inputs:
 - 16 digital inputs with allowable input range from 0V to 12V or 0V to 24V.
 - Expansion module for digital outputs:
 - 16 relay type digital outputs with voltage level of 24V DC.
 - Web server function:
 - HTML web server included in the PLC.
 - Up to 16 sessions at the same time.
 - Compatible with most common search engines.
 - Connector for the digital input and output signals.
 - Connector to the Ethernet switch module (N-SWT-4 or N-SWT-8).

③.2 AE-PLC-MR4. Rotary Table Workstation 4

The "AE-PLC-MR4" is an automatic filling and bottling workstation commanded by a PLC. The workstation "AE-PLC-MR4" is composed by a manufacturing rotary table that is used to supply bottles and plastic covers. The "AE-PLC-MR4" receive the product from the previous workstation "AE-PLC-CP", and use it to fill each bottle in one position of the rotary table. Once each bottle is filled, it is cover before send it to the next workstation, through a pneumatic manipulator.

Control panel:

- Mushroom head emergency stop push button switch.
- Start and Stop pushbuttons.
- Switch for manual or automatic operation.
- Led stack light.
- Terminal block to connect the individually identified inputs and outputs of the unit.

Electrical components:

Complete Technical Specifications (for main items)

DC Motor.

Solenoid valve.

Pneumatic circuit:

Air treatment unit:

Filter-regulator and water trap.

Manometer with double scale indicator.

Shut-off valve.

Pneumatic double effect external grip clamp.

Rotary pneumatic actuator from 0° to 180°

2 Pneumatic monostable 5/2 solenoid valve.

Sensors:

IR beam detector.

3 Capacitive sensors.

4 reed effect limit switches.

Fault generation module:

Box with lock with key.

Allows generating 20 different faults.

Each fault is generated through toggle switches.

* Available PLC models of different manufacturers: PANASONIC, SIEMENS, OMRON, MITSUBISHI, ALLEN BRADLEY, etc.

The AE-PLC-PAN-UB, PANASONIC PLC Base Unit includes:

- N-ALI02. Domestic Power Supply.

Supply voltage (Single-Phase): 230V AC, PH+N+G.

ON-OFF removable key.

Output Voltage Connections:

Two Single-Phase: 230V AC.

Single-Phase supply wire connecting plug.

Differential magnetothermal, 2 poles, 25A, 30mA AC 6KA.

- N-CPU-PAN. Panasonic CPU Module.

Supply voltage (Single-Phase): 100-240V AC PH+N+G.

Overcurrent protection with fuse.

PLC device, Panasonic FP7:

High processing speed: 11ns per basic instruction (step).

Programming capacity: 120k basic instructions (step).

Data logging capacity: 256k words.

Independent memory for comments: 3MB.

Supports SDHC type generic memory cards up to 32GB.

Expansion module for digital inputs:

16 digital inputs with allowable input range from 0V to 12V or 0V to 24V.

Expansion module for digital outputs:

16 relay type digital outputs with voltage level of 24V DC.

Web server function:

HTML web server included in the PLC.

Up to 16 sessions at the same time.

Compatible with most common search engines.

Connector for the digital input and output signals.

Connector to the Ethernet switch module (N-SWT-4 or N-SWT-8).

6.3 AE-PLC-ALB. Bottling Storage Workstation.

The "AE-PLC-ALB" is an automatic storing system commanded by a PLC. The "AE-PLC-ALB" is composed by 3 degrees XYZ manipulator that uses a cup system with vacuum technology to place each bottle in the correct position of a numbered pallet. The workstation has a HMI screen to visualizing in an easy way the bottling storage. The workstation "AE-PLC-ALB" is the last step in the manufacturing process.

Control panel:

Mushroom head emergency stop push button switch.

Start and Stop pushbuttons.

Switch for manual or automatic operation.

Light indicator.

Led stack light.

Terminal block to connect the individually identified inputs and outputs of the unit.

Electrical components:

2 Electric linear actuators.

DC Motor.

Position detector.

Length: 500 mm.

Connector to the "N-SV" module.

Pneumatic circuit:

Air treatment unit:

Filter-regulator and water trap.

Manometer with double scale indicator.

Shut-off valve.

Double acting pneumatic profiled actuator.

Pneumatic monostable 5/2 solenoid valve.

Vacuum circuit:

Telescopic vacuum cup.

Venturi effect vacuum ejector.

2 Pneumatic monostable 2/2 solenoid valves.

1 Pressure relief valve.

Sensors:

IR beam detector.

2 Reed switches.

Fault generation module:

Complete Technical Specifications (for main items)

Box with lock.

Allows to generate 20 different faults.

Each fault is generated through toggle switch.

* Available PLC models of different manufacturers: PANASONIC, SIEMENS, OMRON, MITSUBISHI, ALLEN BRADLEY, etc.

The AE-PLC-PAN-UB, PANASONIC PLC Base Unit includes:

- N-ALIO2. Domestic Power Supply.
 - Supply voltage (Single-Phase): 230V AC, PH+N+G.
 - ON-OFF removable key.
 - Output Voltage Connections:
 - Two Single-Phase: 230 VAC.
 - Single-Phase supply wire connecting plug.
 - Differential magnetothermal, 2 poles, 25A, 30mA AC 6KA.
- N-CPU-PAN. Panasonic CPU Module.
 - Supply voltage (Single-Phase): 100-240V AC PH+N+G.
 - Overcurrent protection with fuse.
 - PLC device, Panasonic FP7:
 - High processing speed: 11ns per basic instruction (step).
 - Programming capacity: 120k basic instructions (step).
 - Data logging capacity: 256k words.
 - Independent memory for comments: 3MB.
 - Supports SDHC type generic memory cards up to 32GB.
 - Expansion module for digital inputs:
 - 16 digital inputs with allowable input range from 0V to 12V or 0V to 24V.
 - Expansion module for digital outputs:
 - 16 relay type digital outputs with voltage level of 24V DC.
 - Web server function:
 - HTML web server included in the PLC.
 - Up to 16 sessions at the same time.
 - Compatible with most common search engines.
 - Connector for the digital input and output signals.
 - Connector to the Ethernet switch module (N-SWT-4 or N-SWT-8).

The PLC-PAN-K4, PANASONIC PLC Kit 4 (Optional) includes:

- N-HMIA-PAN. Panasonic Large HMI Module.
 - Supply voltage (Single-Phase): 100-240V AC PH+N+G.
 - HMI device:
 - Touchscreen.
 - TFT display of 64K colors and 16:9 format.
 - Size of the display: 187 x 147mm (7 inches).
 - Resolution: 800 x 480 WVGA.
 - Backlight with high brightness of 300cd/m².
 - SD card slot.
 - Connector to the Ethernet switch module (N-SWT-4 or N-SWT-8).
- N-SWT-4. 4 Ports Ethernet Switch Module.
 - Supply voltage (Single-Phase): 100-240V AC PH+N+G.
 - Compact switch module:
 - 4 Ethernet ports.
 - Work as Ethernet interconnection point.

The complete unit includes as well:

Advanced Real-Time SCADA.

Open Control + Multicontrol + Real-Time Control.

Specialized EDIBON Control Software based on LabVIEW.

PLC, HMI and web server programming software.

Projector and/or electronic whiteboard compatibility allows the unit to be explained and demonstrated to an entire class at one time.

Capable of doing applied research, real industrial simulation, training courses, etc.

Remote operation and control by the user and remote control for EDIBON technical support, are always included.

Totally safe, utilizing 4 safety systems (Mechanical, Electrical, Electronic & Software).

Designed and manufactured under several quality standards.

Optional software for the realization of 2D and 3D simulation, variables monitoring and SCADA control of the flexible manufacturing system.

Optional ICAI software to create, edit and carry out practical exercises, tests, exams, calculations, etc. Apart from monitoring user's knowledge and progress reached.

This unit has been designed for future expansion and integration. A common expansion is the EDIBON Scada-Net (ESN) System which enables multiple students to simultaneously operate many units in a network.

④ SAC. Silent Air Compressor Unit

Designed to work with the EDIBON units.

Single-phase motor with 340 W.

Low noise level with 40 dB of maximum.

Boiler capacity: 9 l.

Maximum pressure: 8 bar or 0.8 MPa.

Maximum air flow: 50 l/min.

Safety relief valve.

Start/stop switch.

Double scale manometer psi and bar with a range from 0 to 12 bar to measure the air pressure before the air filter regulator.

Air Filter Regulator (FR):

Double scale manometer psi and bar with a range from 0 to 12 bar to measure the air pressure after the air filter regulator.

Air filter with drain.

Air pressure regulator from 0 to 8 bar.

6 mm quick release connector of 6mm for pneumatic flexible tubes.

Oil level indicator.

The oil necessary to work is included with the unit.

Include the connector types to work with pneumatic trainers of EDIBON.

5 AE-PLC-FMS14/CCSOF. Computer Control +Data Acquisition+Data Management Software:

The three softwares are part of the SCADA system.

Compatible with the industry standards.

Flexible, open and multicontrol software, developed with actual windows graphic systems, acting simultaneously on all process parameters.

Management, processing, comparison and storage of data.

It allows the registration of the alarms state and the graphic representation in real time.

Open software, allowing the teacher to modify texts, instructions. Teacher's and student's passwords to facilitate the teacher's control on the student, and allowing the access to different work levels.

This unit allows the 30 students of the classroom to visualize simultaneously all the results and the manipulation of the unit, during the process, by using a projector or an electronic whiteboard

6 Cables and Accessories, for normal operation.

7 Manuals:

This unit is **supplied with 7 manuals:** Required Services, Assembly and Installation, Control Software, Starting-up, Safety, Maintenance & Practices Manuals.

Exercises and Practical Possibilities to be done with the Main Items

Practical possibilities to be done with the Flexible Manufacturing System 4 (AE-PLC-FMS14):

- 1.- Introduction to flexible manufacturing system (FMS).
- 2.- Introduction to pneumatics and electro-pneumatics.
- 3.- Study of the sensor detection.
- 4.- Testing the digital inputs and outputs of the automatic system through a PLC.
- 5.- Modify manufacturing parameters through the PLC.
- 6.- Configuration of a pneumatic application.
- 7.- Introduction to the Human-machine interface systems (HMI).
- 8.- Study of an automatic control of an industrial system.
- 9.- Control of the flexible manufacturing system through a central PLC in an Ethernet network with local PLC in each workstation.
- 10.- Manage the flexible manufacturing system through the HMI device.
- 11.-SCADA control of an automatic industrial system through PC.

Practical possibilities to be done with the optional software Automation Systems Simulation Software (AE-AS):

- 12.- Introduction to the SCADA control system.
- 13.- OPC server system with Ethernet.
- 14.- SCADA control of an automatic industrial system through PC.

Practical possibilities to be done with the Workstation alone:

- Industrial Control Processes Workstation (AE-PLC-CP).
- 15.- Manual control of a water tank temperature.
- 16.- Manual control of a water tank level.
- 17.- Manual control of a water flow.
- 18.- Manual control of a water pressure.
- 19.- Automatic control of a water tank temperature through an industrial controller.
- 20.- Automatic control of a water tank level through an industrial controller.
- 21.- Automatic control of a water flow through an industrial controller.
- 22.- Automatic control of a water pressure through an industrial controller.
- 23.- Change the parameters of the different controls.
- 24.- Optimize the process time of the different industrial controls.
- 25.- Study and analysis of the faults inserted in the process with the fault generation module.
- Rotary Table Workstation 4 (AE-PLC-MR4).
- 26.- Manual control of the rotary table system.
- 27.- Manual control of a bottles feeding system.
- 28.- Manual control of a filling system.
- 29.- Manual control of a bottles covering system.
- 30.- Automatic control of the rotary table system.
- 31.- Automatic control of a bottles feeding system.
- 32.- Automatic control of a filling system.
- 33.- Automatic control of a bottles covering system.
- 34.- Change the parameters of the process.
- 35.- Optimization of the process time.
- 36.- Study and analysis of the faults inserted in the process with the fault generation module.
- Bottling Storage Workstation (AE-PLC-ALB).
- 37.- Manual control of the bottles storage system.
- 38.- Automatic control of the bottles storage system.
- 39.- Change the parameters of the storage process.
- 40.- Optimize the process time.
- 41.- Study and analysis of the faults inserted in the process with the fault generation module.

Other possibilities to be done with this Unit:

- 42.- Many students view results simultaneously.
To view all results in real time in the classroom by means of a projector or an electronic whiteboard.
- 43.- Open Control, Multicontrol and Real Time Control.
This unit allows intrinsically and/or extrinsically to change the span, gains; proportional, integral, derivative parameters; etc, in real time.
- 44.- The Computer Control System with SCADA allows a real industrial simulation.
- 45.- This unit is totally safe as uses mechanical, electrical and electronic, and software safety devices.
- 46.- This unit can be used for doing applied research.
- 47.- This unit can be used for giving training courses to Industries even to other Technical Education Institutions.
- 48.- Control of the AE-PLC-FMS14 unit process through the control interface box without the computer.
- 49.- Visualization of all the sensors values used in the AE-PLC-FMS14 unit process.
- Several other exercises can be done and designed by the user.

Tender Specifications (for optional items)

a) Technical and Vocational Education configuration

⑧ **AE-PLC-FMS14/ICAI. Interactive Computer Aided Instruction Software System:**

This complete software package consists of an Instructor Software (EDIBON Classroom Manager - ECM-SOF) totally integrated with the Student Software (EDIBON Student Labsoft - ESL-SOF). Both are interconnected so that the teacher knows at any moment what is the theoretical and practical knowledge of the students.

- ECM-SOF. EDIBON Classroom Manager (Instructor Software).

ECM-SOF is the application that allows the Instructor to register students, manage and assign tasks for workgroups, create own content to carry out Practical Exercises, choose one of the evaluation methods to check the Student knowledge and monitor the progression related to the planned tasks for individual students, workgroups, units, etc...so the teacher can know in real time the level of understanding of any student in the classroom.

Innovative features:

- User Data Base Management.
- Administration and assignment of Workgroup, Task and Training sessions.
- Creation and Integration of Practical Exercises and Multimedia Resources.
- Custom Design of Evaluation Methods.
- Creation and assignment of Formulas & Equations.
- Equation System Solver Engine.
- Updatable Contents.
- Report generation, User Progression Monitoring and Statistics.

- ESL-SOF. EDIBON Student Labsoft (Student Software).

ESL-SOF is the application addressed to the Students that helps them to understand theoretical concepts by means of practical exercises and to prove their knowledge and progression by performing tests and calculations in addition to Multimedia Resources. Default planned tasks and an Open workgroup are provided by EDIBON to allow the students start working from the first session. Reports and statistics are available to know their progression at any time, as well as explanations for every exercise to reinforce the theoretically acquired technical knowledge.

Innovative features:

- Student Log-In & Self-Registration.
- Existing Tasks checking & Monitoring.
- Default contents & scheduled tasks available to be used from the first session.
- Practical Exercises accomplishment by following the Manual provided by EDIBON.
- Evaluation Methods to prove your knowledge and progression.
- Test self-correction.
- Calculations computing and plotting.
- Equation System Solver Engine.
- User Monitoring Learning & Printable Reports.
- Multimedia-Supported auxiliary resources.

b) Multipost Expansions options

⑨ **MINI ESN. EDIBON Mini Scada-Net System for being used with EDIBON Teaching Units.**

MINI ESN. EDIBON Mini Scada-Net System allows up to 30 students to work with a Teaching Unit in any laboratory, simultaneously.

The MINI ESN system consists of the adaptation of any EDIBON Computer Controlled Unit with SCADA integrated in a local network.

This system allows to view/control the unit remotely, from any computer integrated in the local net (in the classroom), through the main computer connected to the unit.

Main characteristics:

- It allows up to 30 students to work simultaneously with the EDIBON Computer Controlled Unit with SCADA, connected in a local net.
- Open Control + Multicontrol + Real Time Control + Multi Student Post.
- Instructor controls and explains to all students at the same time.
- Any user/student can work doing "real time" control/multicontrol and visualisation.
- Instructor can see in the computer what any user/student is doing in the unit.
- Continuous communication between the instructor and all the users/students connected.

Main advantages:

- It allows an easier and quicker understanding.
- This system allows you can save time and cost.
- Future expansions with more EDIBON Units.

The system basically will consist of:

This system is used with a Computer Controlled Unit.

- Instructor's computer.
- Students' computers.
- Local Network.
- Unit-Control Interface adaptation.
- Unit Software adaptation.
- Webcam.
- MINI ESN Software to control the whole system.
- Cables and accessories required for a normal operation.

* Specifications subject to change without previous notice, due to the convenience of improvement of the product.



C/ Del Agua, 14. Polígono Industrial San José de Valderas.
28918 LEGANÉS. (Madrid). ESPAÑA.
Tel.: 34-91-6199363 FAX: 34-91-6198647
E-mail: edibon@edibon.com WEB site: www.edibon.com

Edition:: ED02/17
Date: December/2017

REPRESENTATIVE

